



EUROPEAN CENTRAL BANK

EUROSYSTEM

T2S FRAMEWORK AGREEMENT

BETWEEN

**[INSERT THE NAME OF THE ACTING EURO AREA
NCB/ECB]**

**ACTING IN THE NAME AND ON BEHALF OF ALL
OF THE MEMBERS OF THE EUROSYSTEM**

AND

[INSERT THE NAME OF THE CONTRACTING CSD]

T2S Framework Agreement

TABLE OF CONTENTS

LIST OF SCHEDULES

PREAMBLE

CHAPTER 1 SCOPE, INTERPRETATION AND STRUCTURE

Article 1 Scope

Article 2 Interpretation and structure

CHAPTER 2 RIGHTS AND OBLIGATIONS OF THE PARTIES

Article 3 Representations of the Parties

Article 4 Multilateral Character of T2S

Article 5 Access Criteria; Non-discriminatory access

Article 6 Duty of loyal cooperation and information

Article 7 Assignment and subcontracting

Article 8 Compliance with Legal and Regulatory Requirements, separation of functions

Article 9 Availability of expert personnel

Article 10 Compliance with Cyber Resilience and Information Security requirements

Article 11 T2S Network Service Provider

Article 12 Directly Connected Parties

Article 13 *Intentionally left blank*

Article 14 *Intentionally left blank*

Article 15 Obligations of the Eurosystem related to testing

Article 16 Obligations of the Contracting CSD related to testing

Article 17 *Intentionally left blank*

Article 18 Obligations of the Eurosystem related to migration

Article 19 Obligations of the Contracting CSD related to migration

Article 20 Obligations of the Eurosystem related to the provision and use of the T2S Services

Article 21 Obligations of the Contracting CSD related to the provision and use of the T2S Services

Article 22 Obligations of the Parties related to the Securities Account balances

Article 23 Crisis management

CHAPTER 3 PARTICIPATION AND CONTROLLING RIGHTS OF THE CONTRACTING CSD

Article 24 Scope of the participation and controlling rights

Article 25 Change and Release Management

Article 26 Examination of T2S Services and records retention

Article 27 Governance

CHAPTER 4 INTELLECTUAL PROPERTY RIGHTS, CONFIDENTIALITY AND DATA PROTECTION

Article 28 Intellectual Property Rights

Article 29 Confidentiality

Article 30 Data protection

CHAPTER 5 LIABILITY

Article 31 Standard of liability

Article 32 Liability rules

Article 33 Indemnification obligations of the Contracting CSD for acts of Third Parties

Article 34 Force Majeure and acts by Third Parties

T2S Framework Agreement

CHAPTER 6 SUSPENSION, TECHNICAL DISCONNECTION, DURATION AND TERMINATION

Article 35 Right of suspension by the Eurosystem

Article 36 Right of technical disconnection by the Eurosystem

Article 37 Term

Article 38 Termination for cause

Article 39 Termination for convenience

Article 40 Financial consequences of termination

Article 41 Duties of the Parties after notification of termination

CHAPTER 7 Miscellaneous

Article 42 Dispute resolution and escalation

Article 43 Arbitration

Article 44 Own fees and costs

Article 45 Public announcements

Article 46 Entire Agreement and non-retroactivity

Article 47 Amendments

Article 48 No waiver

Article 49 Survival

Article 50 Notices

Article 51 Invalid or incomplete provisions

Article 52 No agency or transfer of undertaking

Article 53 Joint liability

Article 54 Choice of law

T2S Framework Agreement

LIST OF SCHEDULES AND ANNEXES

Schedule 1	Definitions
Schedule 2	<i>[intentionally left blank]</i>
Schedule 3	User Testing
Schedule 4	Migration
Schedule 4 Annex	1. List of Migration dates
Schedule 5	T2S Service Description
Schedule 6	T2S Service Level Agreement (SLA)
Schedule 6 Annex	1. Management of non-functional changes
Schedule 7	Pricing
Schedule 7 Annex	1. List of Reports and Queries and business items
Schedule 8	Governance
Schedule 8 Annexes	1. Mandate of the T2S CSG 2. T2S deliverables list and management process 3. Joint Controllership Arrangement
Schedule 9	Change and Release Management
Schedule 9 Annexes	1. Change Request Form 2. Change Request Status
Schedule 10	Operational Risks, Cyber Resilience and Information Security
Schedule 11	Exit Management
Schedule 12	<i>[intentionally left blank]</i>
Schedule 13	Procedure for payment of claims

T2S Framework Agreement

This Agreement is entered into on the Agreement Date between [insert name and place of registered office of acting euro area NCB/ECB] acting in the name and on behalf of all of the members of the Eurosystem,

and

[insert name and place of registered office of Contracting CSD] (hereinafter the 'Contracting CSD')

The parties to this Agreement are referred to collectively as the 'Parties' or individually as a 'Party'.

PREAMBLE

- (1) On 17 July 2008, the Governing Council of the European Central Bank (the 'ECB') decided to launch the development of TARGET2-Securities ('T2S'), a neutral and borderless pan-European service for securities settlement in Central Bank Money (CeBM), to be operated by the Eurosystem. T2S aims to facilitate post-trading integration by enabling the central securities depositories ('CSDs') to provide their customers with harmonised and commoditised settlement services in an integrated technical environment with cross-border capabilities.
- (2) The basic foundations of T2S are laid down in Guideline ECB/2012/13 of 18 July 2012¹, as amended, while the rules and procedures for implementing the eligibility criteria for the CSDs to access T2S are laid down in ECB Decision ECB/2011/20 of 16 November 2011², as amended.
- (3) The Contracting CSD is a CSD regulated and authorised under specific laws and regulations to act, inter alia, as an operator of Securities Settlement Systems and wishes to use the T2S Services for securities settlement in CeBM. The Contracting CSD will outsource certain IT development and operational activity to the Eurosystem, as necessary for the Eurosystem to operate T2S. The Contracting CSD will maintain full control over the business and contractual relationship with its customers and over the parameters of its business operations, which includes the Contracting CSD's ability to monitor and control the processing of its business operations in T2S in accordance with the terms of this Agreement. T2S is a settlement solution and is not a CSD, nor a Securities Settlement System.
- (4) In order to coordinate the interaction of payment and securities settlement services in terms of finality, the Parties acknowledge that the Contracting CSD shall adhere to the Collective Agreement, entered into between the Central Banks operating the TARGET component systems and the Signatory CSDs.
- (5) In view of the above, this Agreement sets out the rights and obligations of the Parties.

¹ OJ L 215, 11.8.2012, p. 19-29.

² OJ L 219, 2.12.2011, p. 117-123.

CHAPTER 1 SCOPE, INTERPRETATION AND STRUCTURE

Article 1

Scope

- 1 This Agreement sets out the rules that govern T2S and the provision of the T2S Services by the Eurosystem to the Contracting CSD, and the Contracting CSD's use of the same, as specified in Schedule 5 (T2S Service Description).
- 2 The Contracting CSD shall have no contractual relationship with the 4CB, other than in the capacity of each of these four Central Banks as members of the Eurosystem, and waives any recourse against the 4CB in connection with the matters covered by this Agreement to the extent permissible by applicable law.
- 3 The Eurosystem shall have no contractual relationship with the Contracting CSD's customers related to the Eurosystem's provision of T2S Services to the Contracting CSD. The Contracting CSD shall remain exclusively responsible for its business and contractual relations with its customers, including Directly Connected Parties ('DCPs'), in relation to its services enabled by the Eurosystem's provision of the T2S Services, or other services provided in the Contracting CSD's capacity as a CSD or as an operator of a Securities Settlement System.
- 4 The Contracting CSD shall remain exclusively responsible for its relationship with the Relevant Competent Authorities regarding its use of the T2S Services. Without prejudice to other provisions of this Agreement, the Eurosystem shall refrain from intervening in this relationship without the Contracting CSD's prior written consent or request. The rights and obligations of the Parties in this respect are further detailed in Article 8.

Article 2

Interpretation and structure

- 1 In this Agreement references:
 - (a) to applicable laws, Schedules, Annexes or other documents shall be deemed to refer, unless specified otherwise, to the respective applicable laws, Schedules, Annexes or other documents;
 - (b) to this Agreement (whether included in the Articles of the Agreement or in a Schedule or an Annex) shall include the Schedules and the Annexes;
 - (c) to 'include', 'includes', 'including', 'in particular' or 'e.g.' means 'without limitation';
 - (d) to persons shall include individuals (*natürliche Personen*) and legal entities (*juristische Personen*) and shall include the permitted transferees and assignees of such individuals and legal entities;

T2S Framework Agreement

- (e) to the holder of any office or position of responsibility include references to such person as is from time to time appointed to exercise the functions of the holder;
 - (f) to any service or other matter or item as described, listed or specified in this Agreement shall include references to such service or other matter or item as removed, replaced, amended or edited from time to time under the terms of this Agreement;
 - (g) words in the plural shall have the same meaning when used in the singular and vice versa; and
 - (h) references to legal acts shall be to the most recent version of those legal acts.
- 2 The heading and table of contents of this Agreement shall not affect its construction or interpretation.
- 3 This Agreement is composed of the Preamble and of Articles 1 to 54 as well as of Schedules 1 to 13 and the Annexes to the Schedules. The Schedules and the Annexes to the Schedules form part of this Agreement and shall have the same force and effect as if expressly set out in Articles 1 to 54. Schedule 1 (Definitions) sets out the meaning of the terms in this Agreement, which are written with initial capital letters, other than proper nouns or titles of the Schedules to the Agreement. In the event of a conflict between stipulations contained in Articles 1 to 54 and those contained in a Schedule or an Annex, as the case may be, the stipulations contained in Articles 1 to 54 shall prevail. In the event of a conflict or inconsistency between Schedule 1 (Definitions) and the other Schedules, or between such other Schedules, Schedule 1 (Definitions) shall prevail over the other Schedules and shall be used to resolve conflicts or inconsistencies between such other Schedules. In the event of a conflict between a Schedule and an Annex, the terms of the Schedule shall prevail. In the event of a conflict or inconsistency between this Agreement and any other document referenced or referred to in it, this Agreement shall prevail.
- 4 Where this Agreement contains a German term as a translation of an English term, the German term shall be binding for the interpretation of this Agreement.
- 5 The T2S Scope Defining Set of Documents is part of this Agreement, unless and to the extent expressly specified to the contrary in this Agreement or in the T2S Scope Defining Set of Documents. In case of such specification, the relevant part of the T2S Scope Defining Set of Documents shall have only interpretative value. The T2S Scope Defining Set of Documents may be complemented from time to time in accordance with Schedule 9 (Change and Release Management). The Eurosystem shall aim at ensuring consistency between the T2S Scope Defining Set of Documents and the T2S Service Description (Schedule 5) at all times. In the event of inconsistencies between the T2S Scope Defining Set of Documents and the T2S Service Description (Schedule 5), the T2S Service Description (Schedule 5) shall prevail. In case of inconsistencies between the individual documents of the T2S Scope Defining Set of Documents, the last version of the most detailed document approved by the Parties in accordance with Schedule 8 Annex 2 (T2S deliverables:

T2S Framework Agreement

list and management process) concerning the issue shall prevail. If a requirement/function is not specified in the GFS or the UDFS, the URD shall prevail. The T2S Documentation is not part of this Agreement unless and insofar expressly specified to the contrary in this Agreement. The T2S Documentation may be complemented from time to time by the Eurosystem in accordance with Schedule 8 Annex 2 (T2S deliverables: list and management process). The Eurosystem shall make the T2S Documentation available to the Contracting CSD.

CHAPTER 2 RIGHTS AND OBLIGATIONS OF THE PARTIES

Article 3

Representations of the Parties

- 1 The Eurosystem represents the following at the Agreement Date and throughout the term of this Agreement:
 - (a) in accordance with Articles 17, 18 and 22 of the Statute of the ESCB, the Eurosystem has and shall maintain in effect all the necessary statutory powers and authorisations to provide the T2S Services in performance of its public tasks;
 - (b) the execution and performance of this Agreement have been duly authorised by all necessary action of the decision-making bodies of the Eurosystem, in accordance with the Statute of the ESCB.

- 2 The Contracting CSD represents the following:
 - (a) at the Agreement Date and throughout the term of this Agreement, the execution and performance of this Agreement have been duly authorised by all necessary action of the decision-making or other relevant bodies of the Contracting CSD.
 - (b) as from the Migration Date and then throughout the term of this Agreement, and without prejudice to Article 38(3)(a), the Contracting CSD has and shall maintain in effect all the necessary rights, powers, and authorisations to perform its obligations under this Agreement, including, in particular, all licenses, permits and consents required in order to use the T2S Services.

Article 4

Multilateral Character of T2S

- 1 The Parties acknowledge that T2S is multilateral in character in that it aims at facilitating European post-trading integration by supporting cash and securities settlement in CeBM, thereby combining the interests of Signatory CSDs, Central Banks and all other T2S Actors. The Parties agree that actions that would have a material negative impact on any of the Signatory CSDs or would not be in line with the aim

T2S Framework Agreement

of achieving securities settlement in CeBM are incompatible with the Multilateral Character of T2S. The T2S Services shall be provided to the Signatory CSDs on the basis of uniform requirements and Governance rules, which include a framework for Specific Changes. The Contracting CSD acknowledges that the Eurosystem will offer Parallel T2S Framework Agreements to all CSDs that are eligible to use the T2S Services in accordance with the conditions set out in Article 5.

- 2 The Parties shall use reasonable efforts: a) to cooperate with each other in identifying any subject matters related to T2S that would benefit from further harmonisation and in supporting consequent adaptations to the legal and regulatory framework; b) to adapt their operational, internal guidelines as well as their processes and related technical systems in order to foster the development of the European post-trading infrastructure, and maintain the Multilateral Character of T2S. The Contracting CSD shall also use reasonable efforts to make efficient use of the T2S Services.

Article 5

Access Criteria; Non-discriminatory access

- 1 The Eurosystem may allow any CSD to access the T2S Services if it is eligible in accordance with the Access Criteria, as specified in paragraph 2. The Eurosystem shall apply such Access Criteria in a fair and non-discriminatory manner.
- 2 CSDs shall be eligible to access T2S Services as Signatory CSDs provided they:
 - (a) have been notified to the European Securities and Markets Authority (ESMA) under Article 10 of Directive 98/26/EC or, in the case of a CSD from a non-European Economic Area (EEA) country, operate under a legal and regulatory framework that is equivalent to that in force in the European Union Member States;
 - (b) have been positively assessed by the Relevant Competent Authorities against (i) Regulation (EU) No 909/2014 of the European Parliament and of the Council³, for CSDs located in a EEA country, or (ii) the Principles for Financial Market Infrastructures of the CPMI – IOSCO⁴ or a legal framework implementing those principles, for CSDs located in a non-EEA country;
 - (c) make each security/International Securities Identification Number (ISIN) for which they are an Issuer CSD (or Technical Issuer CSD) available to other Participating CSDs upon request;
 - (d) commit to offer to other Participating CSDs Basic Custody Services on a non-discriminatory basis;
 - (e) commit to other Participating CSDs to carry out their settlement in CeBM in T2S if the relevant currency is available in T2S.

³ OJ L 257, 28.8.2014, p. 1.

⁴ CPMI-IOSCO, Principles for Financial Market Infrastructures (April 2012).

T2S Framework Agreement

- 3 The Contracting CSD shall comply with the Access Criteria at the latest from the Migration Date to T2S and throughout the term of this Agreement. The Eurosystem shall assess the compliance with the Access Criteria. The Contracting CSD shall promptly inform the Eurosystem of any change affecting its compliance with the Access Criteria occurring during the term of this Agreement. If deemed appropriate, the Eurosystem may reassess the compliance with the Access Criteria. The Contracting CSD agrees that the Eurosystem has the right to request at any time confirmation and evidence regarding its compliance with the Access Criteria.
- 4 The Eurosystem may grant a derogation from the Access Criterion set out in paragraph 2(e) in line with Decision (ECB/2011/20).

Article 6

Duty of loyal cooperation and information

In the exercise of its rights and the performance of its obligations under this Agreement each Party shall:

- (a) act in good faith and collaborate with the other Party closely and transparently in their contractual relations; and
- (b) promptly give to the other Party notice of facts and any information that may reasonably affect its own or the other Party's ability to perform its obligations under this Agreement in any material respect.

Article 7

Assignment and subcontracting

- 1 The Contracting CSD shall inform the Eurosystem as soon as reasonably practicable if it has outsourced or subcontracted any part of its obligations under this Agreement to a Third Party. Where the Contracting CSD outsources or subcontracts any of its tasks, it shall remain liable to the Eurosystem for the performance of its duties and obligations under this Agreement.
- 2 Any assignment or transfer of a right or an obligation of a Party arising out of or in connection with this Agreement shall be subject to the prior written approval of the other Party and such approval may not be unreasonably withheld or delayed. Such approval shall not be required for (a) the assignment or transfer of a right to an Affiliate of a Party; or (b) the assignment or transfer of a right enabling the exercise of a right of recourse of an insurance company of a Party to the extent that the claim or damage suffered by that Party is subrogated to such insurance company.
- 3 Due to the public nature of T2S, the operation and running of T2S can only be entrusted to one or more euro area NCBs. The development and operation of T2S is performed by the 4CB, by an Affiliate of the 4CB, or by one or more euro area NCBs belonging to the 4CB, as part of an internal distribution of work within the Eurosystem and is not to be considered as assigning, transferring, outsourcing or subcontracting within the meaning of this Article. The Eurosystem may outsource or subcontract to a Third Party its tasks under this Agreement that are material for the

T2S Framework Agreement

performance of the Eurosystem's obligations under this Agreement only with the express, prior and written consent of the T2S CSD Steering Group ('T2S CSG') as described in paragraph 4 and such approval may not be unreasonably withheld or delayed. Outsourcing and subcontracting within the meaning of this Article do not include the procurement of services which are not core tasks that CSDs outsource to the Eurosystem, and therefore no consent of the T2S CSG is needed for such outsourcing and subcontracting. The dispute resolution mechanism set up in Article 42 shall apply in case of disagreement.

- 4 Where the consent of the T2S CSG referred to in paragraph 3 is needed, the Eurosystem shall pre-advise the T2S CSG and the Signatory CSDs as soon as possible of any planned action, and shall give reasonable prior notice with details of the proposed terms and conditions pursuant to which such action would take place, and shall request the consent of the T2S CSG. The T2S CSG shall give its response within 14 calendar days by providing its consent, or reasoned refusal of consent, or by indicating within which deadline it would be able to provide an answer to the Eurosystem. In any event, such additional time to respond shall not exceed four weeks from the receipt of the request. The T2S CSG shall approve its consent by a double majority vote of the Signatory CSDs as set out in Schedule 8 (Governance). The consent shall be deemed to be given to the Eurosystem if it has been provided by a double majority of the Signatory CSDs that responded to the Eurosystem request within 14 calendar days from receiving the Eurosystem's request or, if applicable, within the additional time to respond as described above. Where a reply from a Signatory CSD or the T2S CSG does not reach the Eurosystem within 14 calendar days or, if applicable, within the additional time to respond as described above, this is considered implied consent to the outsourcing or subcontracting.
- 5 Where the Eurosystem outsources or subcontracts any of its tasks in accordance with paragraph 3, it shall remain liable to the Contracting CSD for the performance of its duties and obligations under this Agreement. If the Eurosystem outsources or subcontracts a task to a Third Party, it shall ensure, as much as appropriate, that its subcontractors are bound by confidentiality and data protection obligations. If the task outsourced or subcontracted by the Eurosystem is a material task, it shall also ensure that its subcontractors are subject to Business Continuity and Disaster Recovery arrangements similar to those contained in this Agreement and that it retains an adequate level of control over such Third Party, including, if necessary, a right to access the subcontractor's relevant premises, records, systems and/or staff. The Eurosystem, in defining its subcontractors' obligations, shall take into account the need to ensure adequate cooperation with the Contracting CSD for the purpose of helping the Contracting CSD as a regulated entity to meet its Legal and Regulatory Requirements.

Article 8

Compliance with Legal and Regulatory Requirements, separation of functions

- 1 Both Parties acknowledge that this Agreement is without prejudice to the Legal and Regulatory Requirements applicable to the Contracting CSD concerning inter alia

T2S Framework Agreement

the powers and responsibilities of the Relevant Competent Authority and consequently shall have no influence on such powers and responsibilities, which remain exclusively in charge of the supervision and oversight of the Contracting CSD. As regards access to relevant information and on-site inspections, the Relevant Competent Authorities maintain the legal and regulatory powers applicable under the jurisdiction in which the CSD operates.

- 2 Both Parties recognise that the Contracting CSD is directly responsible to the Relevant Competent Authorities with regard to compliance with the Legal and Regulatory Requirements and that in neither of these functions have the Contracting CSD's responsibilities been delegated to the Eurosystem. The Contracting CSD shall exercise its rights and perform its obligations under this Agreement at all times in compliance with the applicable Legal and Regulatory Requirements and shall ensure that its staff, agents and employees act in compliance with such requirements. The Contracting CSD shall promptly inform the Eurosystem of all Legal and Regulatory Requirements applicable to it and any changes to such requirements or any evolutions in their interpretation and application, when compliance with such requirements needs to be considered in connection with the provision or use of the T2S Services. The Eurosystem shall provide reasonable assistance to the Contracting CSD in meeting its Legal and Regulatory Requirements and in ensuring that the Contracting CSD's use of the T2S Services does not lead to non-compliance with such requirements, to the extent that it was informed by the Contracting CSD and to the extent that such requirements are compatible with the Multilateral Character of T2S.
- 3 The Eurosystem shall maintain contact with the relevant European Union institutions and bodies, and the Relevant Competent Authorities to the extent necessary under this Agreement.
- 4 Each of the Eurosystem Central Banks shall maintain at all times a clear separation between (a) its role as a Party to this Agreement; (b) its regulatory, supervisory and oversight functions; (c) its function as an operator of its own CSD, if applicable; and (d) its role as euro area NCB belonging to the 4CB, if applicable.
- 5 Based on Articles 127 of the TFEU and Article 3 of the Statute of the ESCB, in the T2S context, the Eurosystem shall in particular:
 - (a) exclusively exercise full control over all cash accounts in euro in T2S, i.e. operate the cash accounts it holds for Third Parties and safeguard the integrity of the euro which, for the purposes of this Agreement, includes the implementation of monetary policy including all central bank credit operations, as well as settlement in CeBM in the euro;
 - (b) contribute to the smooth conduct of policies pursued by the Relevant Competent Authorities relating to the prudential supervision of credit institutions and the stability of the financial system;
 - (c) ensure that it does not distort a level playing field for market participants;

T2S Framework Agreement

- (d) carry out efficient oversight of their market infrastructure while preserving the separation of this function in line with paragraph 4 above.
- 6 To the extent relevant and subject to the T2S Currency Participation Agreements, non-euro area NCBs in T2S shall have the same rights and obligations in T2S as the Eurosystem in relation to their respective currencies.
- 7 The Eurosystem shall promote good governance aimed at avoiding conflicts between the non-euro area NCBs in T2S operating and oversight functions.

Article 9

Availability of expert personnel

Each Party shall ensure that the duties and obligations under this Agreement are performed by sufficient and qualified personnel, who have appropriate expertise and are trained in the tasks in which they are engaged.

Article 10

Compliance with Operational Risks, Cyber Resilience and Information Security requirements

- 1 The Eurosystem shall in accordance with and as described in Schedule 10 (Operational Risks, Cyber Resilience and Information Security):
 - (a) implement the Cyber Resilience and Information Security framework for T2S;
 - (b) implement a review process to keep the Cyber Resilience and Information Security framework fit for purpose and up-to-date, to appropriately manage Operational Risks and especially Cyber Resilience and Information Security risks in an evolving threat landscape;
 - (c) perform all activities related to Cyber Resilience and Information Security in accordance with the provisions set out in Schedule 10 (Operational Risks, Cyber Resilience and Information Security);
 - (d) report the results of risk assessment and security reviews to the Contracting CSD;
 - (e) report Cyber Resilience and Information Security incidents and the related treatment to the Contracting CSD in accordance with the provisions set out in Schedule 10 (Operational Risks, Cyber Resilience and information Security);
 - (f) provide all other relevant information to the Contracting CSD to allow it to fulfil its own risk management obligations.
- 2 In view of adequately managing the Operational Risks related to T2S, the Contracting CSD shall:

T2S Framework Agreement

- (a) ensure its own compliance with Cyber Resilience and Information Security requirements according to its internal standards, Regulatory Requirements and/or best practices;
 - (b) report to the Eurosystem newly identified risks and/or threat scenarios that might threaten the confidentiality, availability or integrity of the data in T2S Services.
- 3 The Parties shall cooperate according to the following provisions:
- (a) the Eurosystem shall at least on a yearly basis deliver an update of the risk situation, as further specified in Schedule 10 (Operational Risks, Cyber Resilience and Information Security);
 - (b) the Eurosystem shall set up and maintain a multilateral coordination substructure, in accordance with the Governance, for the coordination and monitoring of the T2S Cyber Resilience and Information Security Risk Management activities, as further specified in Schedule 10 (Operational Risks, Cyber Resilience and Information Security);
 - (c) if a disagreement arises in the substructure, each Party shall be entitled to escalate the issue to the T2S Steering Level and shall have, if the disagreement persists, the ultimate possibility to initiate the dispute resolution procedure specified in Article 42, as further specified in Schedule 10 (Operational Risks, Cyber Resilience and Information Security);
 - (d) if a new Cyber Resilience and Information Security risk is identified, or if an existing Cyber Resilience and Information Security risk obtains a higher likelihood or impact score, the Eurosystem shall communicate such changes to the Contracting CSD in accordance with the incident response times specified in Schedule 6 (T2S Service Level Agreement), as further specified in Schedule 10 (Operational Risks, Cyber Resilience and Information Security);
- 4 Any matters related to operational risk, which are not covered by this Article or in Schedule 10 (Operational Risks, Cyber Resilience and Information Security), will be managed directly by the T2S Steering Level.
- 5 The Eurosystem will implement an appropriate risk management framework and inform the Signatory CSDs monthly about the risk situation.

Article 11

T2S Network Service Provider

- 1 The Eurosystem shall allow the Contracting CSD and its DCPs to connect their IT systems to the T2S Platform via a connection through a Network Service Provider (NSP) to the Eurosystem Single Market Infrastructure Gateway (ESMIG).
- 2 The Contracting CSD shall use reasonable efforts to ensure that its own connectivity with the T2S Platform functions properly at all times. The Contracting CSD shall

T2S Framework Agreement

provide in its rules or contractual terms for an obligation to be imposed on its DCPs to use reasonable efforts to ensure that their connectivity with the T2S Platform functions properly at all times.

- 3 The Contracting CSD shall inform the Eurosystem of its intention to change its Network Service Provider (NSP) as soon as reasonably possible.
- 4 The following provisions shall apply:
 - (a) The Eurosystem shall select the NSPs for the provision of Connectivity Services to the Contracting CSD. The requirements according to which the NSPs are selected, and which they need to comply with, are specified in the attachments 1.1 (technical requirements) and 1.2 (business requirements) of the Concession Contracts signed between the Eurosystem and the selected NSPs. The Eurosystem shall communicate to the Contracting CSD the NSPs that it has selected from time to time and will keep the Concession Contracts published on the website of Banca d'Italia. Changes to these requirements will be managed in accordance with Schedule 9 (Change and Release Management) and the Concession Contracts.
 - (b) The Eurosystem shall exercise due care in the coordination of the Contracting CSD's monitoring of the compliance of the NSP(s) with those requirements pursuant to paragraph 4(a) which the Contracting CSD can monitor itself. The Eurosystem shall exercise due care in the monitoring of the compliance of the NSP(s) with those requirements which the Contracting CSD cannot monitor itself. The Eurosystem shall address material breaches of such requirements in accordance with the relevant contractual provisions with the NSP(s). If the Contracting CSD connects to T2S via an NSP in respect of which the Eurosystem has identified a material breach or a potential material breach of the requirements, the Eurosystem will inform the Contracting CSD about the (potential) material breach it has identified, as well as about the steps it has undertaken to remedy (or avoid) such a (potential) material breach. Should the material breach by the NSP not be remedied in a reasonable timeframe, the Eurosystem shall take the appropriate measures towards the NSP, subject to the Eurosystem's arrangements with the NSP, and provide support to the Contracting CSD.
 - (c) The Contracting CSD shall carry out its own due assessment as regards the ability of the selected NSP(s) to offer a connection to the Contracting CSD and as regards the reliability of the NSP(s) (financially, operationally, technically or otherwise) towards the Contracting CSD. The Contracting CSD may not rely solely on the results of the selection process undertaken by the Eurosystem regarding the selection of the NSP(s).
 - (d) The Eurosystem shall not be responsible for any cost or loss that the Contracting CSD may incur as a result of a need to transition to a different NSP if the NSP with which the Contracting CSD has contracted the Connectivity Services loses, for whatever reason, its status as an NSP.

T2S Framework Agreement

- (e) For the avoidance of doubt, the Contracting CSD and the DCP shall not be responsible to the Eurosystem for the acts and omissions of its NSP(s). The Contracting CSD shall inform the Eurosystem about any concerns it may have regarding the operational, technical or financial reliability of its NSP(s) as well as any performance issues regarding delivery of the connection provided by its NSP(s). The Eurosystem shall assess whether or not the information provided by the Contracting CSD could reasonably indicate non-compliance by the NSP of the requirements referred to in paragraph 4(a). If the Eurosystem, acting reasonably, decides that the NSP does not comply with the relevant requirements, the Eurosystem shall forthwith take appropriate steps against the NSP, subject to the Eurosystem's arrangements with the NSP. At all times, the Eurosystem shall keep the Contracting CSD informed of the steps it is taking and discuss the proposed actions with the Contracting CSD in advance.
- (f) The Parties shall monitor the risk situation of the NSPs within their respective contractual relationships with their NSPs, and discuss them as appropriate within the Cyber Resilience and Information Security framework.
- (g) The Parties shall analyse the impact on the T2S Change and Release Management, whenever the Eurosystem starts a new selection process of a NSP.
- (h) The provision of Connectivity Services is outside of the scope of the T2S Services and the Eurosystem is not responsible to the Contracting CSD for the acts and omissions of the NSP(s).

Article 12

Directly Connected Parties

- 1 The Contracting CSD shall maintain a contractual relationship with the DCP that it has designated to the Eurosystem. The Eurosystem shall not maintain a contractual relationship with that DCP for the matters dealt with under this Agreement.
- 2 The Contracting CSD shall only have the obligations in respect of the DCP that it has designated, as provided for in this Agreement and in the T2S Scope Defining Set of Documents. The Contracting CSD shall reflect the obligations that need to be performed by the DCP in relation to the T2S Services in its contractual relationship with such DCP.
- 3 Without prejudice to Article 1(4), in all matters covered by the subject matter of this Agreement, and without prejudice to its provisions, the Eurosystem can interact in particular with the Contracting CSD's DCPs for the purposes of managing the technical connections to T2S, DCP Certification in user testing and crisis management.

T2S Framework Agreement

Article 13

Intentionally left blank

Article 14

Intentionally left blank

Article 15

Obligations of the Eurosystem related to testing

As further specified in Schedule 3 (User Testing) the Eurosystem shall:

- (a) coordinate the User Testing activities and communication between the Contracting CSD and the Central Banks whose currencies are available for settlement in T2S as well as between the Contracting CSD and other CSDs participating in the User Testing activities;
- (b) inform the Contracting CSD about the results of User Testing as defined in Schedule 3 (User Testing);
- (c) *Intentionally left blank*;
- (d) *Intentionally left blank*;
- (e) define the DCP certification tests required to assess that the systems of the DCPs of the Contracting CSD cannot harm T2S due to an inappropriate technical communication or operational procedure;
- (f) prepare the necessary non-functional tests and execute these non-functional tests in order for the Eurosystem to confirm the non-functional compliance of T2S;
- (g) remedy any material deficiency defined as critical defect (priority 1) and, for any defect defined as high defect (priority 2), either directly resolve the defect or, if agreed with the Contracting CSD, as a first step, provide a technical or procedural workaround and, as a second step, resolve the defect within a specific timeframe to be defined along with the workaround to ensure that the T2S Services are established in accordance with the principles set out in Schedule 5 (T2S Service Description) and the T2S Scope Defining Set of Documents;
- (h) provide reasonable support for testing activities of the Contracting CSD in the different stages of User Testing;
- (i) cooperate with the Contracting CSD in respect of the Contracting CSD's acceptance tests of the T2S Services.

Article 16

Obligations of the Contracting CSD related to testing

As further specified in Schedule 3 (User Testing) the Contracting CSD shall:

T2S Framework Agreement

- (a) support the Eurosystem in the preparation of the overall User Testing calendar by providing the Eurosystem with its proposed Test Plan and User Testing calendar of its activities;
- (b) *Intentionally left blank*;
- (c) monitor that its DCPs execute the mandatory test cases and test scenarios for DCP Certification;
- (d) cooperate with the Eurosystem in respect of its acceptance tests of the T2S Services.

Article 17
Intentionally left blank

Article 18

Obligations of the Eurosystem related to Migration

The Eurosystem shall provide the Contracting CSD with reasonable support related to its activities necessary for completing its Migration to T2S.

As further specified in Schedule 4 (Migration), the necessary procedures and tools for Migration aim at facilitating a smooth change-over of the Contracting CSD's operations from its legacy systems to T2S.

Article 19

Obligations of the Contracting CSD related to Migration

As further specified in Schedule 4 (Migration) the Contracting CSD shall:

- (a) adjust its internal systems, processes, interfaces and connections to enable its Migration to T2S in compliance with the Access Criteria and the T2S Documentation, and to achieve operational and technical readiness for the use of the T2S Services;
- (b) set up its own project plan for the Migration and do whatever is reasonably required to ensure that its customers, including DCPs, are able to migrate to the T2S-enabled services of the Contracting CSD by the Migration Date;
- (c) determine, in co-operation with Participating CSDs, the date of its Migration in accordance with the criteria and the conditions, subject to the Eurosystem's rights specified in Schedule 4 (Migration);
- (d) migrate to T2S in accordance with the process specified in Schedule 4 (Migration);
- (e) cooperate with the Eurosystem in documenting that its Migration has been successfully completed;

T2S Framework Agreement

- (f) pay the Conditional Participation Fee of EUR 50,000.00 to the Eurosystem for the support related to the activities necessary for completing its Migration to T2S. The Contracting CSD shall pay the Conditional Participation Fee to the Eurosystem at the latest on the 15th calendar day from the Agreement Date. Upon the Migration of the Contracting CSD to T2S, the Conditional Participation Fee shall be set off against the T2S fees payable by the Contracting CSD to the Eurosystem for the use of the T2S Services, in accordance with Schedule 7 (Pricing);
- (g) execute the mandatory test cases and test scenarios for CSD certification.

Article 20

Obligations of the Eurosystem related to the provision and use of the T2S Services

- 1 For the provision and use of T2S Services, the Eurosystem shall:
 - (a) provide to the Contracting CSD the T2S Services specified in Schedule 5 (T2S Service Description);
 - (b) implement Common and Specific Changes to the T2S Services as requested by the Contracting CSD and managed by the Eurosystem in accordance with Article 25 and Schedule 9 (Change and Release Management);
 - (c) maintain the T2S Services so as to support, in cooperation with the Contracting CSD, ongoing compliance with the applicable Legal and Regulatory Requirements, as detailed in Article 8(1), without prejudice to the application of Article 25 and Schedule 9 (Change and Release Management) to changes that may need to be implemented as a result of such requirements;
 - (d) reinstate operations to permit use of the T2S Services following a failure as specified in Schedule 6 (T2S Service Level Agreement);
 - (e) update in a timely manner the T2S Documentation;
 - (f) provide the Contracting CSD with financial statements, reports and other information on T2S on a regular basis that fairly represent the business and financial conditions, result of operations and state of the cost recovery in relation to T2S on the respective dates or for the respective periods covered by such financial statements, reports and other information.
- 2 Changes to the T2S Platform or T2S Business Application that need to be implemented urgently in order to restore or continue the provision of the T2S Services in accordance with the service levels specified in Schedule 6 (T2S Service Level Agreement) may be autonomously decided and implemented by the Eurosystem in accordance with Schedule 6 (T2S Service Level Agreement) and the Manual of Op-

T2S Framework Agreement

erational Procedures (MOP). In such cases, the Eurosystem shall inform the Contracting CSD as soon as reasonably practicable on the nature and characteristics of the changes and the time in which the change shall be implemented.

- 3 The Eurosystem shall make available to the Contracting CSD a monthly Service Level Report to determine the degree of the Eurosystem's compliance with Schedule 6 (T2S Service Level Agreement), in particular as regards the Key Performance Indicators (KPIs). If the Eurosystem fails to meet any of the KPIs, it shall in cooperation with the Contracting CSD:
 - (a) investigate the underlying cause of the failure;
 - (b) take necessary measures to minimise the impact of the failure;
 - (c) take necessary measures to prevent the failure from recurring or report on the cause, the status and the remedies required to prevent recurrence of the failure.

Article 21

Obligations of the Contracting CSD related to the provision and use of the T2S Services

- 1 The Contracting CSD shall use the T2S Services once: (a) the User Testing is completed as specified in Article 16 and Schedule 3 (User Testing); and (b) Migration has been successfully completed as specified in Article 19 and Schedule 4 (Migration).
- 2 In pursuance of its obligation to use the T2S Services, the Contracting CSD shall, in particular:
 - (a) perform the duties and responsibilities assigned to it in Schedule 6 (T2S Service Level Agreement);
 - (b) support the resumption of the T2S Services following a failure as specified in Schedule 6 (T2S Service Level Agreement);
 - (c) pay the fees in a timely manner and in accordance with the conditions set out in Schedule 7 (Pricing).
- 3 The Contracting CSD shall only present to T2S for processing Transfer Orders on behalf of customers that are 'participants' according to the national implementation of Article 2 of Directive 98/26/EC or, if the Contracting CSD is established outside the European Economic Area, on behalf of customers enjoying an equivalent protection to that in force for 'participants' pursuant to Directive 98/26/EC.
- 4 The Contracting CSD shall make all necessary arrangements with regard to its operational processes and contractual terms, in particular its rules, (a) to aim at harmonising definitions of the moment of entry of Transfer Orders into the system and of the moment of irrevocability of such Transfer Orders, in accordance with Directive

T2S Framework Agreement

98/26/EC, and (b) to ensure the unconditionality, irrevocability and enforceability of the settlement processed on the T2S Platform.

- 5 The Contracting CSD shall review, comment, and consent to or reject the Eurosystem report referred to in the Article 20(3). If the Contracting CSD rejects the report, and in particular the remedies proposed by the Eurosystem for preventing the recurrence of not meeting the KPIs, it may revert to the dispute resolution and escalation procedure set out in Article 42.
- 6 The Contracting CSD shall maintain and be responsible for the accuracy of all Securities Reference Data in T2S for which it is assigned as the Securities Maintaining Entity (SME). The Contracting CSD is the SME in T2S for all securities for which it is the Issuer CSD.

If the Contracting CSD is not the Issuer CSD for a given security, then the Contracting CSD will agree with the other Participating CSDs which Participating CSD will act as SME. The Contracting CSD agrees with the following provisions concerning the responsibilities of the SME for a given security:

- (a) if the Securities Reference Data are required for settlement in T2S, the SME shall ensure that these are created in T2S in a timely manner and shall be responsible for maintaining them thereafter;
 - (b) if the SME is informed of or becomes aware of errors and/or omissions in the Securities Reference Data, it shall correct them within two hours;
 - (c) the Contracting CSD will not create Securities Reference Data for securities for which it is not the Issuer CSD or for which it has not agreed with the other Participating CSDs to act as SME.
- 7 The Contracting CSD, when acting as SME, acknowledges and confirms that it has obtained all authorisations, permits and licences to make available the Securities Reference Data to the Eurosystem for the purposes described in this Agreement. If legal action is commenced or threatened against the Eurosystem based on an alleged infringement of any right relating to such Securities Reference Data, the Eurosystem shall (a) notify the Contracting CSD in accordance with Article 50 as soon as reasonably practicable; (b) allow the Contracting CSD, at its expense, control of the defence of the claim (without prejudice to the Eurosystem's right to take an active role in the proceedings at its own expense); (c) not make admissions, agree to any settlement or otherwise compromise the defence of the claim without the prior written consent of the Contracting CSD; such consent shall not be unreasonably withheld and (d) give, at the Contracting CSD's request, reasonable assistance in connection with the conduct of the defence. If the Eurosystem should be held legally liable for the infringement of the Third Party's right according to an Enforceable Judgement or has, with the prior written consent of the Contracting CSD, settled the claim, the Contracting CSD shall reimburse the Eurosystem in accordance with Schedule 13 (Procedures for Payment of Claims) for all payments that the Eurosystem has to make to the relevant Third Party. The consent referred to in the previous

T2S Framework Agreement

sentence shall not be unreasonably withheld. This reimbursement obligation shall not apply with regard to any Third Party claim asserted before a court outside (a) the European Union or (b) the home country of any Signatory CSD. In this case, the liability rules pursuant to Article 32 shall apply.

- 8 The Eurosystem may reassign the responsibility of the SME for a given security in T2S on a written request from the Contracting CSD and only if another Participating CSD accepts the responsibility as SME for this security.
- 9 The Eurosystem shall not reimburse the SME for any costs related to its responsibility to maintain the Securities Reference Data in T2S, nor shall it be involved in any way in any financial compensation arrangements between the Contracting CSD and the other Participating CSDs.
- 10 The Eurosystem shall not be liable to the Signatory CSDs for any errors or omissions in any Securities Reference Data, nor shall it be involved in any way in the processing of any liability claims between them.
- 11 The Eurosystem may, upon request of the Signatory CSDs, accept to act as SME for a given security. This shall not constitute a T2S Service and the Eurosystem shall not accept any liability in connection with its function as SME.

Article 22

Obligations of the Parties related to Securities Account balances

- 1 Securities Account balances of the Contracting CSD operated on the T2S Platform shall only be changed in T2S.
- 2 The Eurosystem acknowledges that the Transactional Data and CSD Reference Data are essential to the Contracting CSD's operations and that the Contracting CSD will rely on such Transactional Data and CSD Reference Data for the operation of its Securities Accounts. The Eurosystem has no Intellectual Property Rights (IPRs) over the Transactional Data and CSD Reference Data, which remain under the responsibility and control of the Contracting CSD except as provided by and/or required for the execution of this Agreement.
- 3 In providing the T2S Services, the Eurosystem shall process changes to Securities Account balances on the T2S Platform upon Transfer Orders through which the Contracting CSD has been instructed by its Users. The Eurosystem shall have no obligation to monitor the accuracy of the Transfer Orders and may rely in good faith on all Transfer Orders and information communicated and properly authenticated in accordance with the methods described in Schedule 5 (T2S Service Description) and the T2S Scope Defining Set of Documents.
- 4 The Eurosystem warrants that all Transactional Data and CSD Reference Data shall be accessible to and available for the Contracting CSD as specified in Schedule 5 (T2S Service Description). The Contracting CSD shall report to the Eurosystem any errors as soon as reasonably practicable. The Contracting CSD shall require its

T2S Framework Agreement

DCPs to report any such errors to it as soon as reasonably practicable and it shall report such errors to the Eurosystem as soon as reasonably practicable.

- 5 The timing and procedures of error handling are further described in the MOP. The Parties shall collaborate and use their best endeavours to reverse any erroneous changes to any Securities Account balances.

Article 23

Crisis management

- 1 The Eurosystem shall manage and resolve any operational disturbances in T2S. In addition, it shall coordinate, initiate and lead activities in connection with any event of an operational or financial nature which may impact the functioning and performance of T2S. The Eurosystem shall use its best efforts to act to protect the functioning of T2S and to operate T2S in a way that supports the financial stability of all connected markets.
- 2 The principles of Crisis management are laid down in Schedule 5 (T2S Service Description) and Schedule 6 (T2S Service Level Agreement), whereas the procedural aspects of the Crisis management framework are set out in the MOP, without prejudice to the competence of the Relevant Competent Authorities. The Contracting CSD shall, in coordination with the Relevant Competent Authorities, use its best efforts to ensure the compatibility of its Crisis management framework with applicable laws. Moreover, the Contracting CSD shall make reasonable efforts to ensure the compatibility of its Crisis management framework with the T2S Crisis management procedures.
- 3 The details of the assistance to be provided by the Eurosystem in case of a Crisis are specified in the T2S Service Level Agreement and are based on the following principles:
 - (a) the Eurosystem shall have adequate organisational and personnel capacities to deal with a Crisis Situation;
 - (b) the Eurosystem shall fully cooperate with the Contracting CSD, the Participating CSDs, the Relevant Competent Authorities and ESMA in order to manage a Crisis Situation (including investigating the feasibility of and implementing reasonable workarounds);
 - (c) the Eurosystem shall prepare and maintain a Crisis management plan, and shall test its appropriateness together with the Signatory CSDs, the Relevant Competent Authorities and ESMA, on a regular basis;
 - (d) the Eurosystem shall provide a report to the Signatory CSDs, the Relevant Competent Authorities and ESMA on the effective handling of a Crisis Situation within a reasonable period of time after such a Crisis has occurred; and
 - (e) the Eurosystem shall cover and where appropriate involve the DCP in the context of Crisis management.

T2S Framework Agreement

- 4 The details of the assistance to be provided by the Contracting CSD in the case of a Crisis are specified in the Service Level Agreement and are based on the following principles:
- (a) the Contracting CSD shall use its best efforts to fully cooperate with the Eurosystem in order to manage a Crisis Situation;
 - (b) the Contracting CSD shall use its best efforts to inform the Eurosystem about any potential market disturbances that may have an impact on T2S without delay;
 - (c) the Contracting CSD shall use its best efforts to ensure that its own Crisis management plans cover T2S Crisis scenarios;
 - (d) the Contracting CSD shall without undue delay inform and involve its DCP and other users about any T2S Crisis that could impact them; and
 - (e) the Contracting CSD shall use its best efforts to assist in the preparation and maintenance of a Crisis management plan by the Eurosystem.
- 5 In the case of a Crisis, the Contracting CSD shall be entitled to invoke its own Crisis management plan in full cooperation with and where relevant with the approval of the Eurosystem, the Relevant Competent Authorities and ESMA, which may include the settlement of transactions outside T2S, unless this would have a detrimental impact on financial stability.

CHAPTER 3 PARTICIPATION AND CONTROLLING RIGHTS OF THE CONTRACTING CSD

Article 24

Scope of the participation and controlling rights

- 1 The participation and controlling rights of the Contracting CSD in T2S shall include the following:
- (a) the right to submit Change Requests in accordance with the Change and Release Management procedure set out in Article 25 and Schedule 9 (Change and Release Management);
 - (b) the right to request technical and operational examinations by the External Examiner in line with the multi-year T2S examination plan and the Contracting CSD's right to request special examinations by the External Examiner, in accordance with Article 26(1) to (5) of this Agreement;
 - (c) the right to be represented and to participate in the Governance as specified in Article 27 and Schedule 8 (Governance);
 - (d) the right to obtain information as provided for in this Agreement.

T2S Framework Agreement

- 2 The rights set out in paragraphs 1 shall be exercised without prejudice to Article 8 and the principle of Central Bank independence set out in Article 130 and Article 282(3) of the TFEU, Article 7 of the Statute of the ESCB and in relevant national legislation.

Article 25

Change and Release Management

- 1 The Parties may propose Change Requests for the T2S Business Application and T2S Platform, the T2S Scope Defining Set of Documents and requirements for NSPs. Such proposals shall be made and dealt with in accordance with Schedule 9 (Change and Release Management).
- 2 Change and Release Management shall adhere to the following principles:
- (a) T2S is aimed at accommodating market evolution and supporting innovation;
 - (b) without prejudice to the right of the Contracting CSD to submit a request for the implementation of Specific Changes, new or changed services within T2S shall be provided with the objective of being available to all Signatory CSDs and Central Banks in T2S, and through them to T2S Users;
 - (c) without prejudice to the ultimate decision-making powers of the Governing Council, as set out in Schedule 8 (Governance), no individual Signatory CSD shall have a veto right with respect to the approval of changes;
 - (d) T2S shall endeavour to facilitate the Signatory CSDs' compliance with their respective Legal and Regulatory Requirements, to the extent that the Eurosystem was informed by the Signatory CSDs about such requirements and to the extent that they are compatible with the Multilateral Character of T2S;
 - (e) it is the Signatory CSD's responsibility to involve their respective user communities throughout the whole Change and Release Management;
 - (f) the Eurosystem shall continue to be committed to communicating information in a transparent manner towards the market in line with Schedules 8 (Governance) and 9 (Change and Release Management);
 - (g) the development of specific functionalities to accommodate national specificities shall be limited as much as possible. Instead, where applicable, building the necessary interfaces to let the Signatory CSDs and Central Banks offer these national specificities on their platforms, with no impact on T2S, shall be favoured.
 - (h) in the case of changes in respect of Legal and Regulatory Requirements which apply only to one, or a few Signatory CSDs or Central Banks, Specific Changes will be available in accordance with paragraph 3 below;

T2S Framework Agreement

- (i) sufficient time shall be allotted to implement any changes needed for the Eurosystem to develop the T2S Services on a consistent basis and provide enough lead time for the Signatory CSDs and the non-euro area NCBs in T2S to change their own internal systems, processes, interfaces and connections accordingly.
- 3 The following principles apply to Specific Changes:
- (a) a Signatory CSD or a Central Bank which has a specific need, triggered by Legal and Regulatory Requirements or by innovation/improvements, may request a new functionality, provided that this does not endanger the Lean Scope of T2S and is not incompatible with the Multilateral Character of T2S; and
 - (b) the requesting Signatory CSD or Central Bank shall formally commit itself to bear the financial consequences of the Specific Change in accordance with Schedule 7 (Pricing); and/or
 - (c) the associated costs shall be shared among all Signatory CSDs and/or Central Banks making use of the given functionality in accordance with Schedule 7 (Pricing); and
 - (d) the Specific Changes shall be approved in accordance with Schedule 9 (Change and Release Management); and
 - (e) no Specific Changes may be implemented if this imposes changes to existing features, functionalities, processes or interfaces or a deterioration of the service level of other CSDs or Central Banks, that have not approved such Specific Changes and unless these CSDs or Central Banks agree to them.
- 4 In accordance with Article 28(2) but subject to Article 28(3), the Contracting CSD waives any IPRs that it may have acquired in connection with the proposed changes to the T2S Services or that may have arisen in the context of Change and Release Management. Should any other legal entity or natural person who would have been associated directly or indirectly with the Change and Release Management Procedure, have acquired IPRs in connection with the proposed changes, the Contracting CSD shall: (a) inform the Eurosystem as soon as it becomes aware of potential IPRs vested in such a legal entity or natural person; and (b) use its best endeavours to ensure that such legal entity or natural person also waives any IPRs acquired in the abovementioned context.
- 5 In the case of refusal to implement changes triggered by Legal and Regulatory Requirements, the Governing Council shall provide a full written explanation of the reasons for the refusal.
- 6 The full financial consequences related to Common Changes and Specific Changes shall be recovered in accordance with Schedule 7 (Pricing).

T2S Framework Agreement

- 7 Authorised changes and defect resolutions the implementation of which is pending are prioritised based on a scoring or ranking mechanism. The definition of the release is based on this priority rating taking into account the business and legal criticality of changes, the associated risks, budgetary implications and the capacity for Common Changes and Specific Changes. The approval of the content of the release and the final prioritisation are carried out as described in Schedule 9 (Change and Release Management).

Article 26

Examination of T2S Services and records retention

- 1 Without prejudice to the principle of Central Bank independence in performance of its public tasks, as established under Article 130 and Article 282(3) of the TFEU and in the relevant national legislation, the performance of T2S Services shall be subject to technical and operational examinations performed by the External Examiner appointed by the Governing Council on the proposal of the T2S CSG and after consultation with the T2S Non-euro Currencies Steering Group ('T2S NECSG'). The costs of the External Examiner, both for regular examinations and for the special examinations according to paragraphs 4 and 6, shall be shared in equal parts between the Eurosystem, on the one side, and the Signatory CSDs, on the other.
- 2 The External Examiner shall be a well-reputed, internationally active accounting firm. It shall perform its services within the scope set by the Governing Council and in accordance with internationally recognised audit standards such as the Statement on Standards for Attestation Engagements (SSAE) No 16 or International Standards for Assurance Engagements (ISAE) No. 3402. The External Examiner shall be changed every 4 years.
- 3 The Governing Council shall set the External Examiner's mission statement and a multi-year examination plan, taking into account examination items proposed by the T2S CSG. The scope of the regular examinations or special examinations should be limited to the provision of T2S Services or directly related activities. The objective of these examinations is to give to the T2S CSG reasonable assurance about whether (a) the organisation set up by the Eurosystem meets the obligations established in this Agreement and (b) the controls implemented by the Eurosystem are suitably designed to meet the security objectives. Moreover, the External Examiner shall deliver an opinion on the effectiveness of the controls performed by the Eurosystem on the basis of the results of the compliance check reviews and of the risks assessment and related treatment plans managed by the Eurosystem. The T2S CSG may also propose to the Governing Council to approve any special examinations to be conducted by the External Examiner outside the multi-year examination plan.
- 4 Where a special examination is necessary because of a severe incident or a material and ongoing problem which has disrupted the proper functioning of the T2S Platform or the provision of T2S Services, the External Examiner shall have access to the relevant technical documentation.

T2S Framework Agreement

- 5 Following the submission of the External Examiner's report of its regular examination, the T2S CSG shall hold an annual meeting, or, in case of a special examination, an extraordinary meeting, with the External Examiner to review the submitted report and to discuss solutions for the identified issues. The report and recommended solutions for the identified issues shall then be submitted to the Governing Council. Within 3 months of receiving the report, the Governing Council shall reply whether it accepts or rejects each of the recommended solutions. If it accepts a recommendation, the Governing Council will describe how it intends to implement such recommendation and in what timeframe. The External Examiner shall then monitor the Eurosystem's progress on implementing the accepted recommendations and report back to the T2S CSG at the annual meeting. If a recommendation is rejected, the Governing Council shall communicate the reasons to the T2S CSG and the Relevant Competent Authority.
- 6 Without prejudice to paragraph 3, the Contracting CSD shall have the right to: (a) propose to the T2S CSG items for the regular examinations and requests for special examinations to be conducted by the External Examiner; (b) receive all External Examiner reports; and (c) request the External Examiner to provide additional explanations to the T2S CSG during an annual meeting referred to in paragraph 5 or in written form following such annual meeting and within its remit. The Contracting CSD and/or the Relevant Competent Authorities shall have the right to propose special examinations to be conducted by the External Examiner directly to the Governing Council.
- 7 If the Governing Council refuses to appoint the External Examiner proposed by the T2S CSG as provided for in paragraph 1 or to include items for the regular or special examination to be conducted by the External Examiner upon the T2S CSG's proposal, the Governing Council shall communicate the reasons for its refusal to the T2S CSG, to the Contracting CSD and/or to the Relevant Competent Authorities. The T2S CSG, the Contracting CSD and/or the Relevant Competent Authorities may submit new proposals to the Governing Council until a mutually agreeable solution is found.
- 8 The Eurosystem shall ensure that the External Examiner has the following rights and obligations related to the performance of its examinations and checks:
 - (a) the External Examiner shall contact the Eurosystem through the indicated contact persons. The External Examiner shall give the Eurosystem prior notice of 14 calendar days before starting the regular examination or an additional check and shall inform the Eurosystem of the following: (a) the object of the examination or check; (b) the names of the authorised representatives of the External Examiner who shall carry out the examination or check; (c) the Eurosystem offices at which the examination or check is to be conducted; (d) the methods to be applied; and (e) the time schedule;
 - (b) the External Examiner shall have the right to examine technical and operational documentation and records, whether in written or electronic form, directly relevant for assessing the performance of the T2S Services and for the setting of

T2S Framework Agreement

the T2S pricing policy and the implementation of the T2S Programme budget. Such technical and operational documentation and records shall be made available, upon request, to the External Examiner's authorised representatives during normal business hours at the relevant Eurosystem offices. The External Examiner shall have the right to make, for its own internal use only, copies and excerpts from the documentation and records made available by the Eurosystem. Such copies and excerpts shall be listed in a transmission protocol and returned to the Eurosystem upon completion of the examination or check and upon confirmation from the External Examiner that no other unauthorised copies or transcripts exist;

- (c) the External Examiner shall ensure that the authorised representatives who carry out the examinations or checks comply with: (a) the internal rules of the relevant Eurosystem member, as communicated to such authorised representatives before the commencement of their activity; and (b) the confidentiality obligations set out in Article 29. The External Examiner's authorised representatives shall not enter areas or offices and shall not use physical or electronic resources of the Eurosystem other than those which are strictly needed for the performance of the examination or check.
- 9 The Eurosystem shall maintain documentation and records documenting the performance of this Agreement for at least 10 years after their creation and, for documents and records maintained at the date of the termination of this Agreement, for at least 10 years following the termination. Such documentation and records shall include any financial records relating to costs and expenses directly related to the performance of this Agreement, as incurred by the Eurosystem on its own behalf or on behalf of the Contracting CSD. Where the Contracting CSD notifies the Eurosystem of any potential or actual litigation requiring preservation of certain records or a change in law establishing longer documentation and records preservation periods the Eurosystem shall forthwith: (a) suspend the destruction of documentation or records, as required by the Contracting CSD; and (b) give the Contracting CSD prior written notice of at least 60 calendar days before destroying the documentation or records subject to such suspension, during which notice period the Contracting CSD may submit a reasoned request for their further maintenance, with the Eurosystem being entitled to reimbursement of reasonable costs incurred as a result of such further maintenance.
- 10 Nothing in paragraph 9 relieves the Contracting CSD or the Eurosystem from their statutory or contractual obligations related to the storage of records and documents.

Article 27

Governance

- 1 Without prejudice to Articles 8(5) and 42, the Governance framework of T2S Services is specified in this article and in Schedule 8 (Governance).
- 2 The Eurosystem shall participate in the Governance of T2S in the performance of its tasks under the TFEU and the Statute of the ESCB and in its capacity as owner

T2S Framework Agreement

and operator of T2S. In particular, this includes the ability to recover its costs and to operate T2S in a safe and efficient manner with due consideration of the rights, interests, prerogatives and obligations of the T2S Stakeholders in line with the Multilateral Character of T2S.

- 3 Participating CSDs shall have control and participation rights in accordance with the Governance framework of T2S, in particular through their participation in the relevant Governance bodies, as set out in paragraph 4, and the decision-making process as outlined in Schedule 8 (Governance) and Schedule 9 (Change and Release Management).
- 4 Without prejudice to the ultimate decision-making powers of the Governing Council, as set out in Schedule 8 (Governance), and the decision making bodies of the non-euro area NCBs in T2S, the Governance bodies are:
 - (a) the Market Infrastructure Board (MIB), whose mandate and composition are set out in Decision (EU) 2019/166 of the European Central Bank of 25 January 2019;
 - (b) the T2S CSG, whose mandate and composition are annexed to Schedule 8 (Governance);
 - (c) the T2S NECSG, whose mandate and composition are set out in Schedule 8 (Governance) of the T2S Currency Participation Agreement;
 - (d) the Governors' Forum, whose mandate and composition are part of the Schedule 8 (Governance) of the T2S Currency Participation Agreement;
 - (e) the Advisory Group on Market Infrastructures for Securities and Collateral (AMI-SeCo), whose mandate and composition are set out in the Annex to Guideline ECB/2012/13 of 18 July 2012, as amended, on TARGET2-Securities; and
 - (f) the National Stakeholder Group (NSGs), whose mandate and composition are set out in the Annex to the Guideline ECB/2012/13 of 18 July 2012, as amended on TARGET2-Securities. The NSGs link the respective national market with the AMI-SeCo.

CHAPTER 4 Intellectual property rights, Confidentiality And Data Protection

Article 28 **Intellectual Property Rights**

- 1 Each Party and, where applicable, its licensors, shall retain all rights and titles in their Background IPRs. In particular, the Eurosystem shall not acquire any right, title or interest in or to the IPRs of the Contracting CSD or its licensors (including but not limited to software, CSD Reference Data, Securities Reference Data, Transactional

T2S Framework Agreement

Data, data, documentation, processes, and procedures of the Contracting CSD), save to the extent required for the performance of this Agreement.

- 2 The Parties agree that no IPRs developed or created before or during the course of this Agreement by or for the benefit of the Eurosystem or its subcontractors shall be transferred, licensed or otherwise conveyed to the Contracting CSD, save as expressly set out in this Agreement. This includes without limitation: (a) all IPRs developed or created in connection with the development of T2S or the establishment or provision of T2S Services; (b) changes to T2S or to the T2S Scope Defining Set of Documents implemented pursuant to Change and Release Management as described in Article 25 and Schedule 9 (Change and Release Management); and (c) the T2S Documentation and any other documents created or used for the development and operations of the T2S.
- 3 Notwithstanding paragraph 2, the Parties may use general project know-how acquired in connection with T2S, in particular in connection with Change and Release Management, including after the termination of this Agreement.
- 4 The Eurosystem shall provide the T2S Services in a manner that shall ensure that no IPR of any Third Party is infringed through the use of T2S Services by the Contracting CSD in line with this Agreement. If legal action is commenced or threatened against the Contracting CSD based on an alleged infringement of the IPR of any Third Party through the use of T2S Services by the Contracting CSD, the Contracting CSD shall (a) notify the Eurosystem in accordance with Article 50 as soon as reasonably practicable; (b) allow the Eurosystem, at its expense, control of the defence of the claim (without prejudice to the Contracting CSD's right to take an active role in the proceedings at its own expense); (c) not make admissions, agree to any settlement or otherwise compromise the defence of the claim without the prior written consent of the Eurosystem; such consent shall not be unreasonably withheld; and (d) give, at the Eurosystem's request, reasonable assistance in connection with the conduct of the defence. If the Contracting CSD should be held legally liable for the infringement of the Third Party's IPR according to an Enforceable Judgement or has, with the prior written consent of the Eurosystem, settled the claim, the Eurosystem shall reimburse the Contracting CSD in accordance with Schedule 13 (Procedure for payment of claims) for all payments that the Contracting CSD has to make to the relevant Third Party. The consent referred to in the previous sentence shall not be unreasonably withheld. This reimbursement obligation shall not apply with regard to any Third Party claim asserted before a court outside (a) the European Union or (b) the home country of the Contracting CSD or any Participating CSD. In this case, the liability rules pursuant to Article 32 shall apply.
- 5 The Eurosystem grants to the Contracting CSD a non-exclusive and non-transferable licence to copy the T2S Documentation and any other document made available to the CSDs for any purpose connected to the use of the T2S Services or other purpose that is incidental to the rights granted to the Contracting CSD under this Agreement.

T2S Framework Agreement

- 6 The T2S trademarks and logos remain the sole property of the Eurosystem. The Eurosystem grants to the Contracting CSD the non-exclusive, non-transferable right to use the T2S trademarks and logos in the territories, in which they are protected, for the T2S Services in conformity with applicable law.
- 7 The Contracting CSD's trademarks and logos remain its (or its Affiliates) sole property. The Contracting CSD grants to the Eurosystem the non-exclusive, non-transferable right to use the Contracting CSD's trademarks and logos in the territories, in which they are protected, for the T2S Services in conformity with applicable law.

Article 29 **Confidentiality**

- 1 The Parties acknowledge and agree that they have received and will receive Confidential Information in connection with this Agreement.
- 2 The Parties agree that all Confidential Information shall be used only for the purpose of exercising rights or complying with obligations under this Agreement and the receiving Party shall ensure that only such personnel to whom disclosure of the Confidential Information is required for the purpose of exercising any rights or the performance of the receiving Party's obligations under this Agreement shall have access to the Confidential Information and only to the extent necessary to exercise these rights or perform these obligations.
- 3 To the extent that Confidential Information disclosed by a Contracting CSD consists of statistical or personal data, such data may only be used to prepare aggregated data for further use by the Eurosystem, provided that such aggregated data does not allow for the direct or indirect identification of the content of the specific Confidential Information or any personal data.
- 4 The receiving Party of Confidential Information shall use all reasonable efforts to protect such Confidential Information from unauthorised use or disclosure (intentional, inadvertent or otherwise) and, in any event, shall exercise at least the same reasonable level of care to avoid any such unauthorised use or disclosure as it uses to protect its Confidential Information.
- 5 Notwithstanding the foregoing, a receiving Party may disclose Confidential Information of the disclosing Party to Third Parties with the prior written consent of the disclosing Party, and each Party shall be free to disclose Confidential Information without the consent of the disclosing Party only:
 - (a) as required by a court of competent jurisdiction or a Relevant Competent Authority or an administrative body of a competent jurisdiction, or otherwise required by the applicable laws, but only to the extent legally required;
 - (b) in any potential or actual litigation among the Parties arising in connection with the T2S Programme or this Agreement, to the extent required to establish, exercise or defend a legal claim;

T2S Framework Agreement

(c) to directors, officers, personnel, attorneys, consultants, auditors, subcontractors, insurers and agents of the Contracting CSD (including persons belonging to an Affiliate of the Contracting CSD) on a strict need-to-know basis in connection with their duties, as long as such persons are advised of the confidential nature of such information and their obligation to protect it as confidential and are bound by confidentiality undertakings consistent with those contained in this Agreement,

provided that, with respect to points (a) and (c), the Party shall, subject to the applicable laws, inform the other Party reasonably in advance in writing in order to enable it to take precautionary measures.

- 6 If this Agreement is terminated or expires for any reason, all Parties that have received Confidential Information shall return it to the disclosing Party and/or, at the disclosing Party's discretion, destroy it and provide a corresponding certificate to the disclosing Party, except to the extent that retention of any Confidential Information is required by applicable laws or expressly permitted under this Agreement. A receiving Party may keep one copy of the Confidential Information for backup, audit and compliance purposes, subject to the obligation to keep this copy confidential and not use the information for any other purpose. This confidentiality obligation shall remain in force following the termination or expiration of this Agreement.
- 7 Nothing in this Article limits the ability of the Parties to provide the text of this Agreement to the relevant European Union institutions and bodies, and national authorities, including the Relevant Competent Authorities, for purposes related to receiving regulatory assessments or approvals necessary for provision and use of the T2S Services or establishing the tax status of the T2S Services.
- 8 The Parties acknowledge and agree that this Agreement is public and will be published on the ECB website.

Article 30

Data protection

1. Each Party shall comply with the data protection laws applicable to it and in particular Regulation (EU) 2016/679⁵ or, as applicable, Regulation (EU) 2018/1725⁶. The Joint Controllorship Arrangement for the processing of personal data resulting from the T2S Services, whose content is included in Annex 3 to Schedule 8 and the relevant sections of the MoP, is binding for each Party.

⁵ OJ L 119 4.5.2016, p. 1.

⁶ OJ L 295, 21.11.2018, p. 39–98.

CHAPTER 5 LIABILITY

Article 31

Standard of liability

- 1 Except as otherwise provided in this Agreement, the Parties shall be bound by a general duty of reasonable care in relation to each other in performing their obligations under this Agreement.
- 2 Each Party shall be obliged to perform only the duties and obligations specifically attributed to it in this Agreement and shall be liable only in respect of those duties and obligations as provided for in this Agreement.
- 3 Each Party shall take all reasonable and practical actions and measures to mitigate any loss, damage or adverse consequence that it may cause to the other Party or that it may suffer by reason of the acts or omissions of the other Party.

Article 32

Liability rules

- 1 Each Party shall be liable to the other Party without limitation for any loss or damage resulting from fraud or wilful misconduct in performing its duties and obligations under this Agreement.
- 2 Each Party shall be liable to the other Party for any Direct Loss incurred resulting from its gross or ordinary negligence in performing its duties and obligations under this Agreement. "Direct Loss", for the purpose of this Agreement, shall mean loss or damage directly caused to the damaged Party as a result of the gross or ordinary negligence of the other Party in performing its duties and obligations under this Agreement. Lost revenues, lost profits, lost savings and reputational damage shall not qualify as Direct Loss; instead they shall qualify as indirect losses. Without prejudice to paragraphs 3 and 9, liability for indirect loss and damages not qualifying as Direct Loss is excluded to the extent permitted by German law.
- 3 The Eurosystem shall also be liable to the Contracting CSD for a claim of a Contracting CSD's customer against the Contracting CSD in connection with T2S Services (hereinafter a 'Customer Claim'), resulting from the Eurosystem's gross or ordinary negligence in performing its duties and obligations under this Agreement, if and to the extent that all of the following criteria are satisfied: (a) the Contracting CSD has, with the approval of the Eurosystem (such approval shall not be unreasonably withheld or delayed), settled the Customer Claim or is held legally liable for the Customer Claim pursuant to an Enforceable Judgment; (b) the loss or damage of a customer is the direct result of an act or omission of the Eurosystem and (c) the Customer Claim would have been settled according to local market practice (marktübliche Bedingungen). The Contracting CSD shall reimburse to the Eurosystem a Customer Claim (i) for which the condition(s) outlined above are not fulfilled or are reversed or (ii) which is paid twice on the basis of this Agreement as well as

T2S Framework Agreement

on another basis, such as an insurance policy or through a claim paid by a Central Bank based on the same facts and circumstances. For the avoidance of doubt, no Customer Claim shall be paid directly by the Eurosystem to the Contracting CSD's customers.

4 Each Party shall be liable to the other Party in proportion of the contribution of its fraud, willful misconduct, gross or ordinary negligence in the loss or damage of the other Party.

5 Without prejudice to paragraph 1, the Eurosystem's liability according to this Article shall be limited or excluded as follows:

(a) The liability of the Eurosystem shall be limited to a maximum total amount per calendar year for all losses or damages suffered by the Signatory CSDs that were caused by events that occurred in the same calendar year.

(i) In case of the Eurosystem's ordinary negligence, the liability of the Eurosystem vis-à-vis, combined, the Signatory CSDs shall be limited to a maximum total amount of EUR 30,000,000 for the relevant calendar year.

(ii) In case of the Eurosystem's gross negligence, the liability of the Eurosystem vis-à-vis, combined, the Signatory CSDs shall be limited to a maximum total amount of EUR 500,000,000 for the relevant calendar year.

If the aggregate amount of losses or damages suffered by the Signatory CSDs in any calendar year exceeds the maximum set out in this subparagraph, then the amount due to the Contracting CSD shall be determined by the Eurosystem pro rata, i.e. having regard to the total amount of all losses or damages suffered by the Signatory CSDs.

(b) The Eurosystem shall not be liable for losses or damages suffered by the Contracting CSD related to the early termination of any Parallel T2S Framework Agreement or any T2S Currency Participation Agreement.

(c) The Eurosystem shall have no liability for the suspension of settlement in the currency of a non-euro area NCB in T2S.

6 Without prejudice to paragraph 1, the Contracting CSD's liability according to this Article shall be limited as follows: in the case of ordinary negligence, the liability shall be limited to the equivalent of the T2S fees that the Contracting CSD has paid during the 12 months period preceding the calendar year in which the event occurred that caused the liability claim or, in case the Contracting CSD has not paid T2S fees for 12 months, the T2S fees that the Contracting CSD could be reasonably expected to have paid during this 12 months period, taking into account the number of securities instructions that the Contracting CSD has settled in its legacy settlement infrastructure during the remainder of the 12 months period. In the case of liability due to gross negligence, the liability shall be limited to the fivefold of the amount as determined in accordance with the previous sentence.

T2S Framework Agreement

7 *intentionally left blank;*

8 *intentionally left blank;*

9 In the event of a delay of the Contracting CSD in completing its Migration to the T2S Platform by the Migration Date, the Eurosystem shall retain the Conditional Participation Fee, irrespective of the Contracting CSD's negligence, but subject to Article 34(1). If loss or damage to the Eurosystem results from a delay of the Contracting CSD in completing its Migration to the T2S Platform by the Migration Date, the liability of the Contracting CSD shall, without prejudice to paragraph 1, not apply to a loss or damage that arises during the first 12 months of such delay. After this period, the Eurosystem's damage shall be equal to the T2S fees that the Contracting CSD could be reasonably expected to pay during the time of its delay. The Contracting CSD's expected T2S fees shall be determined as follows: daily average number of securities instructions that the Contracting CSD settled in its legacy settlement infrastructure during the 12-months period preceding the Contracting CSD's Migration Date multiplied by the relevant T2S prices indicated in T2S Price List multiplied by the number of days in delay.

10 The procedures for the exercise, allocation and payment of liability claims are detailed in Section 1 of Schedule 13 (Procedure for payment of claims).

11 The right of either Party to claim damages pursuant to this Article is excluded to the extent that the Party is entitled to claim financial compensation in accordance with Article 40 for the same event.

12 For the avoidance of doubt, the circumstances specified in Article 34(1) apply as grounds for exclusion of the liability under this Article.

Article 33

Indemnification obligations of the Contracting CSD for acts of Third Parties

1 Notwithstanding Article 34(1)(b), the Contracting CSD shall indemnify and hold harmless the Eurosystem from:

- (a) any claim asserted directly or indirectly against the Eurosystem by a Third Party in relation to the T2S Services used by the Contracting CSD. If legal action is commenced or threatened against the Eurosystem by a Third Party, the Eurosystem shall (a) notify the Contracting CSD in accordance with Article 50 as soon as reasonably practicable; (b) allow the Contracting CSD, at its expense, control of the defence of the claim (without prejudice to the Eurosystem's right to take an active role in the proceedings at its own expense); (c) not make admissions, agree to any settlement or otherwise compromise the defence of the claim without the prior written consent of the Contracting CSD; such consent shall not be unreasonably withheld and (d) give, at the Contracting CSD's request, reasonable assistance in connection with the conduct of the defence. If the Eurosystem should be held legally liable towards the Third Party according

T2S Framework Agreement

to an Enforceable Judgement or has, with the prior written consent of the Contracting CSD, settled the claim, the Contracting CSD shall reimburse the Eurosystem in accordance with Schedule 13 (Procedure for Payment of Claims) for all payments that the Eurosystem has to make to the relevant Third Party. The consent referred to in the previous sentence shall not be unreasonably withheld. This reimbursement obligation shall not apply with regard to any Third Party claim asserted before a court outside (a) the European Union or (b) the home country of the Contracting CSD or any Participating CSD. In this case, the liability rules pursuant to Article 32 shall apply;

- (b) any loss or damage incurred as a result of the acts and omissions of one of the Contracting CSD's customers in relation to T2S.
- 2 The obligations of the Contracting CSD pursuant to paragraph 1 shall not be construed as a limitation of any claim for loss or damage the Contracting CSD may have against the Eurosystem under this Agreement.

Article 34

Force Majeure and acts by Third Parties

- 1 No Party shall be responsible to the other Party for a failure to perform any of its obligations under this Agreement insofar as such failure is due to conditions beyond its reasonable control which result from: (a) Force Majeure; or (b) acts or omissions by any Third Party to the extent that such Third Party's acts or omissions were beyond the reasonable control of the non-performing Party.
- 2 Each Party shall inform the other Party without delay of any actual or imminent failure referred to in paragraph 1, and use its best efforts to resolve such a failure as soon as reasonably possible.

CHAPTER 6 SUSPENSION, TECHNICAL DISCONNECTION, DURATION AND TERMINATION

Article 35

Right of suspension by the Eurosystem

- 1 The Eurosystem shall be entitled to suspend the Contracting CSD from using some or all T2S Services with immediate effect if the Relevant Competent Authority requests or supports the suspension. If the Contracting CSD is subject to an Insolvency Event or is in non-compliance with the Access Criteria, the Eurosystem, together with the Relevant Competent Authority, shall assess the required timing and level of suspension. Where possible, the suspension shall be limited to the T2S Services that are relevant to the cause of the suspension.
- 2 The implementation of the suspension of the Contracting CSD from using some or all T2S Services shall trigger Article 23 on Crisis management. The Eurosystem and the Contracting CSD shall use their best efforts to remove the suspension in collaboration with the Relevant Competent Authorities.

Article 36

Right of Technical Disconnection by the Eurosystem

- 1 The Eurosystem shall be entitled to technically disconnect the Contracting CSD from the T2S Platform with immediate effect if, in the Eurosystem's reasonable opinion, the technical connection of the Contracting CSD to the T2S Platform represents a major threat to the security or integrity of T2S. The Technical Disconnection of the Contracting CSD may cause the Technical Disconnection of its DCPs in accordance with the Crisis management procedures. The Eurosystem shall, to the extent possible, provide reasonable prior notice of the imminent Technical Disconnection to the Relevant Competent Authorities and the Contracting CSD. Where possible, the Eurosystem shall consult the Relevant Competent Authorities prior to the Technical Disconnection.
- 2 The Eurosystem shall be entitled to technically disconnect a DCP from the T2S Platform with immediate effect if, in the Eurosystem's reasonable opinion, the technical connection of such DCP to the T2S Platform represents a major threat to the security or integrity of T2S. The Eurosystem shall, to the extent possible, provide reasonable prior notice of the imminent technical disconnection of the DCP to and consult the Relevant Competent Authorities, the Contracting CSD and the DCP that is impacted.
- 3 The implementation of the technical disconnection of the Contracting CSD or one of its DCPs shall trigger Article 23 on Crisis management. The Eurosystem and the Contracting CSD shall undertake to use their best efforts in order to remove the disconnection after 2 hours, counting from the moment of disconnection. Where possible, the technical disconnection shall be limited to the T2S Services that are relevant to the cause of the disconnection.

T2S Framework Agreement

Article 37

Term

- 1 This Agreement shall be executed on the date hereof and shall become effective on the Agreement Date. The provisions of this Agreement shall not have any retroactive effect except for Articles 6, 28 and 29, which shall apply retroactively.
- 2 This Agreement shall continue unless and until terminated in accordance with this Chapter. There shall be no termination rights other than those set out in this Agreement or those mandatory under applicable law.

Article 38

Termination for cause

- 1 The Contracting CSD shall be entitled to terminate this Agreement in the following cases:
 - (a) *intentionally left blank*;
 - (b) *intentionally left blank*;
 - (c) after migration of the Contracting CSD, the Eurosystem is in material breach of any provision of this Agreement and this breach is not remedied within a reasonable time;
 - (d) after the second year following the migration of the Contracting CSD, the Eurosystem repeatedly and unreasonably refuses to implement a Specific Change.
- 2 The Eurosystem shall be entitled to terminate this Agreement if:
 - (a) the Contracting CSD does not fulfil the Access Criteria for being eligible to the T2S Services as specified in Article 5(2); or
 - (b) the Contracting CSD is in material breach of any other provision of this Agreement and such breach is not remedied within a reasonable time; or
 - (c) the Contracting CSD is subject to an Insolvency Event and the Eurosystem, together with the Relevant Competent Authority, has assessed the required timing for such termination; or
 - (d) the provision of the T2S Services becomes illegal under existing laws or regulations.
- 3 Either Party shall be entitled to terminate this Agreement if:
 - (a) the Relevant Competent Authorities of the Contracting CSD have issued a final and binding decision which prevent the Contracting CSD from using the T2S Services or, if such decision cannot be obtained, the Contracting CSD provides

T2S Framework Agreement

- evidence of the existence of legal or regulatory obstacles that make the use of the T2S Services illegal; or
- (b) the Contracting CSD does not agree with a material change approved pursuant to Article 25 and Schedule 9 (Change and Release Management) and such a change cannot be implemented as a Specific Change.
- 4 Prior to termination by the Eurosystem according to paragraph 2(a), the Eurosystem shall apply the following procedure for determining non-compliance of the Contracting CSD with the Access Criteria:
- (a) Where the MIB determines that the Contracting CSD has not complied with one or more of the Access Criteria, it shall:
- (i) evaluate the nature and seriousness of the non-compliance as well as any repeated occurrences; and
- (ii) submit a written notice informing the Contracting CSD of its conclusions regarding non-compliance.
- (b) The Contracting CSD shall respond to the MIB within one month of receipt of notice by providing relevant evidence.
- (c) Based on the Contracting CSD's response, the MIB may, after having heard the Contracting CSD, where necessary, submit a non-compliance report to the Governing Council. It shall take into account the nature and seriousness of non-compliance by the Contracting CSD as well as any repeated occurrences.
- (d) Following receipt of the MIB's non-compliance report, the Governing Council may issue a reasoned decision regarding non-compliance.
- 5 The Party intending to terminate this Agreement pursuant to paragraph 1 (a), (b) or 2 (b) of this Article shall first revert to the dispute resolution and escalation procedure laid down in Article 42.
- 6 Without prejudice to Article 41(4), the notice period which applies to this Article shall be at least 90 days. In the cases of paragraph 5, notice of termination shall only be given after the dispute resolution and escalation procedure laid down in Article 42 is completed and the issue remains unresolved.

Article 39

Termination for convenience

- 1 The Contracting CSD shall be entitled to terminate this Agreement for convenience at any time by giving prior written notice of termination to the Eurosystem of 24 months.

T2S Framework Agreement

- 2 The Contracting CSD shall also be entitled to terminate this Agreement for convenience at any time by giving prior written notice to the Eurosystem with the financial consequences stipulated in Article 40(1).
- 3 The Eurosystem shall be entitled to terminate this Agreement for convenience at any time by giving prior written notice of termination to the Contracting CSD of 36 months.

Article 40

Financial consequences of termination

- 1 If this Agreement is terminated by the Eurosystem pursuant to Article 38(2)(a), (b) or (c), 38(3)(b) or by the Contracting CSD pursuant to Articles 38(1)(d), (3)(b) or 39(2), the Eurosystem shall be entitled to claim financial compensation from the Contracting CSD. The procedures for the exercise of compensation claims and for the determination of the amounts of compensation are detailed in Section 2 of Schedule 13 (Procedures for payment of Claims). In case of termination by the Contracting CSD pursuant to Article 38(1)(d), the financial compensation to be paid by the Contracting CSD in accordance with Section 2 of Schedule 13 (Procedures for payment of Claims) is reduced by 50 percent.
- 2 If this Agreement is terminated by the Contracting CSD pursuant to Article 38(1)(a), (b) or (c), the Contracting CSD shall be entitled to claim financial compensation from the Eurosystem for the Direct Loss, as defined in Article 32(2), incurred by the Contracting CSD. The Contracting CSD claiming compensation shall provide evidence of the losses for which compensation is claimed. The procedures for the exercise of compensation claims and for the determination of the amounts of compensation, also with regard to the limitation of such claims, are detailed in Section 2 of Schedule 13 (Procedures for payment of claims). For the avoidance of doubt, compensation for losses incurred by either Party resulting from the termination of this Agreement can be claimed only in accordance with Section 2 of Schedule 13 (Procedures for payment of Claims).

Article 41

Duties of the Parties after notification of termination

- 1 The Contracting CSD shall pay fees until the effective date of termination.
- 2 When this Agreement is terminated after the Contracting CSD has migrated to T2S, the Parties shall closely cooperate and the Eurosystem shall reasonably assist the Contracting CSD and use its best efforts in order to support the transfer of activities to the Contracting CSD itself and/or any other service provider selected by the latter. Specifically in case of termination by the Contracting CSD pursuant to Article 38(3)(a), the Eurosystem shall deploy additional assistance and efforts to achieve the objectives stated in this Article.

T2S Framework Agreement

- 3 The details of the cooperation and assistance to be provided by the Eurosystem are specified in Schedule 11 (Exit Management) and are based on the following principles:
 - (a) the Contracting CSD is responsible for the set up and execution of the exit plan; and
 - (b) the Eurosystem shall provide the required assistance, as reasonably necessary, to the Contracting CSD.
- 4 Without prejudice to the termination rights of the Eurosystem pursuant to Article 38(2)(a), (b), (c) and (d), 38(3)(a) and (b), the Eurosystem shall, upon request of the Contracting CSD, continue to provide the T2S Services to the Contracting CSD for a period of up to 24 months after the date of the service of notice of termination, but not beyond the effectiveness of such termination, as long as the Contracting CSD complies with the Access Criteria. In case the Contracting CSD cannot comply with all Access Criteria, the Parties, together with the Relevant Competent Authority, shall assess the required level of provision of T2S Services.
- 5 The Eurosystem shall maintain at the disposal of the Contracting CSD the relevant documents, data and archives related to T2S Services provided to the Contracting CSD.
- 6 From the date of notification of termination, the Contracting CSD shall become an observer in the entities or bodies governing T2S in which it participated. As an observer, the Contracting CSD shall not be entitled to vote, unless decisions relate to the day-to-day management and operation of T2S. From the effectiveness of termination, the Contracting CSD shall be excluded from any entities or bodies governing T2S.

CHAPTER 7 Miscellaneous

Article 42

Dispute resolution and escalation

- 1 The Eurosystem and the Contracting CSD shall attempt to resolve disputes involving: (a) the Eurosystem and the Contracting CSD, or, as the case may be, (b) the Eurosystem, the Contracting CSD and one or more Participating CSDs, and which arise out of or relate to this Agreement, any Parallel T2S Framework Agreements or the provision or use of the T2S Services, in a constructive manner that reflects their respective concerns and legitimate interests. The first attempt to resolve a dispute shall be, as soon as the circumstances allow, through negotiations between the Eurosystem, the Contracting CSD and, as the case may be, the involved Participating CSDs.

T2S Framework Agreement

- 2 If the attempt to resolve a dispute through negotiations is unsuccessful, the Eurosystem, the Contracting CSD or any Participating CSD involved in the dispute may escalate the matter to the T2S CSG. The T2S CSG shall attempt to resolve the dispute and find a mutually agreeable solution within 60 calendar days from the date of the first meeting of the T2S CSG in which the dispute was discussed. The T2S CSG may establish a Resolution Task Force, grouping representatives of the Eurosystem and of the CSDs involved, selected with the view to ensuring balanced representation of the whole T2S CSG.
- 3 If no mutually agreeable solution can be reached by the T2S CSG, the issue may be escalated to the MIB. Any Party to the dispute may address the MIB with submissions in writing. The MIB shall deliver its proposal for the resolution of the matter within 60 calendar days after the dispute has been submitted to the MIB in writing to the Parties involved.
- 4 If the Parties involved in the dispute do not agree to the resolution proposal made by the MIB, they shall notify the MIB within 60 calendar days and the MIB Chairperson shall without delay inform the Governing Council of this outcome. The MIB Chairperson shall make a reasoned proposal of the resolution options to the Governing Council, documenting the status of the dispute and the positions of the Eurosystem, the Contracting CSD and, if applicable, the Participating CSDs. Any Party to the dispute may address the Governing Council with submissions in writing. As a result of its review, the Governing Council shall decide on the resolution of the dispute within a reasonable time.
- 5 At any point of the procedure described in paragraphs 1 to 4, advice on the disputed issues from the Advisory Group and the T2S NECSG may be requested by the MIB Chairperson, by the Contracting CSD, by any Participating CSD involved in the dispute, by the T2S CSG, and by the Governing Council. The Advisory Group and the T2S NECSG shall provide their advice without delay and in due time for it to be considered before the escalation procedure is concluded or moved to the next stage. The Advisory Group and the T2S NECSG may request at any stage of the escalation procedure an appropriate prolongation of the time for giving their respective advice, if necessary for the adequate preparation of the advice.
- 6 At each stage of the escalation process, adequate consideration shall be given to related matters that are the subject of similar escalation procedures between the Eurosystem and a non-euro area NCB in T2S.

Article 43 **Arbitration**

- 1 The Parties agree that any dispute between the Parties arising out of or in connection with this Agreement shall be decided through proceedings between all Parties to this Agreement and that any dispute shall, subject to the prior completion of the dispute resolution and escalation procedure set out in Article 42, be brought before the Court of Justice of the European Union by either of the Parties in accordance with Article 35.4 of the Statute of the ESCB.

T2S Framework Agreement

- 2 The members of the Eurosystem can internally agree to authorise a Eurosystem Central Bank to act in the name and on behalf of all the other members of the Eurosystem in all matters related to an Arbitration arising under this Article. Any such agreement shall promptly be communicated by the Eurosystem to the Contracting CSD.

Article 44

Own fees and costs

Each Party shall bear its own costs and expenses connected with the preparation, execution and application of this Agreement (including the costs of its legal and other advisors), without prejudice to other provisions of this Agreement.

Article 45

Public announcements

Without prejudice to Articles 8 and 29(7), the Parties shall not issue nor allow for any press releases or communications relating to the performance or non-performance of either Party under this Agreement without the prior written approval of the other Party.

Article 46

Entire Agreement and non-retroactivity

The Agreement, the Schedules and the Annexes represent the complete agreement regarding the subject-matter hereof and replace any prior oral or written communications between the Eurosystem and the Contracting CSD, including those resulting from the T2S Memorandum of Understanding.

Article 47

Amendments

- 1 Any amendment of, or supplement to, this Agreement must be executed in writing and agreed by both Parties unless provided otherwise in this Article. Written form in the meaning of this Article requires a formal document containing the amendment or supplement with a statement that the document is intended to amend or supplement this Agreement. The document shall be duly signed by Authorised Representatives of the Parties.
- 2 The Eurosystem shall notify the T2S CSG of its intention to amend the Schedules with regard to minor changes of a technical or operational nature. These minor changes shall be deemed to be approved unless the T2S CSG or the Contracting CSD, within 21 calendar days, notifies the Eurosystem that in its view such changes may not be considered minor. In the latter case, the amendment procedure according to paragraph 1 shall apply.
- 3 The Parties agree to negotiate in good faith to amend this Agreement, to the extent required, in the event that any of the legal acts or instruments forming an element

T2S Framework Agreement

of the overall legal framework for T2S, including for the avoidance of doubt any relevant legal act or instrument that applies in the jurisdiction of the Contracting CSD, is amended and in the event any such amendment has a material effect on this Agreement in the reasonable opinion of the Eurosystem or of the Contracting CSD.

- 4 The Parties shall implement the system changes decided pursuant to Article 25 and Schedule 9 (Change and Release Management). The scope of system changes is further defined in Schedule 9 (Change and Release Management).
- 5 The Eurosystem may, except as provided otherwise under paragraph 6 and subject to paragraph 4 regarding system changes, amend the Annexes to the Schedules, with the T2S CSG's agreement.
- 6 The Eurosystem may amend Schedule 7 (Pricing), with prior notice of 180 calendar days to the Contracting CSD, in accordance with the T2S pricing policy decided by the Governing Council and published on the ECB website or if the actual usage of T2S Services that have an initial zero price is not within an expected consumption pattern. This is without prejudice to the account management service fee for securities accounts which will be kept at zero until the end of the Cost Recovery Period and which the Eurosystem may only amend with prior notice of 24 months to the Contracting CSD.
- 7 The need to amend this Agreement shall be assessed by the Parties on a yearly basis. This annual assessment aims at ensuring that material evolutions in the T2S Platform, relevant to the balance of the contractual relationship between the Parties, are reflected in this Agreement.

Article 48

No waiver

The exercise or waiver, in whole or in part, of any right, remedy, or duty provided for in this Agreement shall not constitute the waiver of any prior, concurrent or subsequent right, remedy, or duty within this Agreement.

Article 49

Survival

Any terms of this Agreement that by their nature extend beyond its expiration or termination shall remain in effect until fulfilled, including those concerning examination and records retention, Confidential Information, Arbitration, governing law and jurisdiction, indemnification, Intellectual Property Rights, limitation of liability, limitations period, charges, credits and payments, survival, and warranty.

T2S Framework Agreement

Article 50

Notices

All notices to be given or other communications to be made pursuant to this Agreement shall be valid only if made in writing, including e-mail or facsimile transmission, to the Authorised Representative notified as such by the other Party.

Except as otherwise provided for in the MOP, all notices of the Contracting CSD to the Eurosystem in relation to this Agreement shall be submitted to the entity having executed this Agreement on behalf of the Eurosystem.

Article 51

Invalid or incomplete provisions

If a provision of this Agreement is or becomes invalid or incomplete, the validity of the other provisions of this Agreement shall not be affected thereby. The invalid or incomplete provision shall be replaced or supplemented by a legally valid provision that is consistent with the Parties intentions or with what would have been the Parties intentions according to the aims of this Agreement had they recognised the invalidity or incompleteness. It is the Parties' intention that this Article shall not merely result in a reversal of the burden of proof but that Section 139 of the BGB is contracted out in its entirety.

Article 52

No agency or transfer of undertaking

- 1 Except for the **[insert the name of the acting euro area NCB/ECB]** acting in the name and on behalf of the Eurosystem, this Agreement shall not be construed to deem either Party as a representative, agent, employee, partner, or joint venturer of the other Party. The Eurosystem shall not have the authority to enter into any agreement, nor to assume any liability, on behalf of the Contracting CSD, nor to bind or commit the Contracting CSD in any manner, except as provided hereunder.
- 2 Nothing in this Agreement shall be construed as a transfer of the Contracting CSD's undertaking, or any part thereof, including any employment contracts, to the Eurosystem.

Article 53

Joint liability

As part of the Eurosystem's tasks in accordance with Articles 17, 18 and 22 of the Statute of the ESCB and of the ECB, T2S has the nature of a public service. All obligations of the Eurosystem arising under this Agreement can only be performed jointly by all members of the Eurosystem and qualify as a joint liability. All rights and claims of the Contracting CSD under this Agreement are therefore always rights and/or claims that can be exercised only against all members of the Eurosystem jointly.

T2S Framework Agreement

Article 54
Choice of law

The Agreement shall be governed by the laws of Germany.

[Signature page(s) follow(s).]

T2S Framework Agreement

Signed in :

On behalf of: **[Insert name of the acting euro area NCB/ECB]**,

acting in the name and on behalf of the Eurosystem

Date:

Full name

Signature

Signed in :

On behalf of: **INSERT THE NAME OF THE CONTRACTING CSD**

Date:

Full name

Signature



EUROPEAN CENTRAL BANK

EUROSYSTEM

T2S FRAMEWORK AGREEMENT

SCHEDULE 1 DEFINITIONS

T2S Framework Agreement

Schedule 1 – Definitions

In this Agreement, unless the context requires otherwise, terms with an initial capital letter have the following meanings:

‘4CB’	means the Deutsche Bundesbank, the Banco de España, the Banque de France and the Banca d’Italia, collectively, in their capacity as euro area NCBs responsible for building, maintaining and running the T2S Platform based on the relevant contractual arrangements and on decisions of the Governing Council.
‘Access Criteria’	means the access criteria for Central Securities Depositories (CSDs) wishing to use the T2S Services, as set out in Article 15 of Guideline ECB/2012/13 and further detailed in Decision ECB/2011/20. These are also referred to as the eligibility criteria, as adopted by the Governing Council on 14 January 2010.
‘Advisory Group on Market Infrastructures for Securities and Collateral (AMI-SeCo)’	means the T2S Advisory Group on Market Infrastructures for Securities and Collateral, the mandate and composition of which is set out in the Annex to Guideline ECB/2012/13, as amended.
‘Affiliate’	means a legal entity which, with respect to any person, directly, or indirectly through one or more intermediaries, controls, is controlled by or is under common control with the person in question. For the purposes of this definition, ‘control’ means the possession, directly or indirectly, of more than 50% of the equity interests of a person or the power to direct or cause the direction of the management and policies of a person, in whole or in part, whether through ownership of voting interests, by contract or otherwise.
‘Agreement’ or ‘T2S Framework Agreement (FA)’	means the contractual arrangement composed of a core agreement, including Schedules and Annexes, between a Contracting CSD and a euro area NCB or the European Central Bank (ECB), acting in the name and on behalf of all the members of the Eurosystem.
‘Agreement Date’	means the date on which both contracting parties signed the T2S Framework Agreement.
‘Annex’	means an Annex to one of the Schedules of this Agreement.
‘Application-to-Application (‘A2A’)	means a connectivity mode to exchange information between the T2S software application and the application(s) at the T2S Actor.
‘Arbitration’	has the meaning set out in Article 43 of this Agreement.
‘Authorised Representative’	means the individual appointed by either party to such role and notified to the other party in accordance with Article 47 of this Agreement.
‘Background IPRs’	means all IPRs owned by or licensed to the Contracting CSD or the Eurosystem prior to the Agreement Date.

T2S Framework Agreement

Schedule 1 – Definitions

'Basic Custody Service'	means the holding and administration of securities and other financial instruments, by an entity entrusted with such tasks. Basic Custody Service includes the safekeeping of securities, the distribution of interest and dividends on the securities in safekeeping, and the processing of corporate actions on the said securities.
'Batch Settlement'	means the set of sequenced, scheduled processes in T2S that settle or attempt to settle all instructions that are eligible for settlement on a transaction-by-transaction basis.
'BGB'	means the Bürgerliches Gesetzbuch (the German Civil Code).
'Business Continuity and Disaster Recovery'	means the set of rules and procedures aimed at resuming normal T2S Services in compliance with the Service Levels as described in Schedule 6 (T2S Service Level Agreement), after the occurrence of an Incident, as well as at mitigating the impact of such an Incident.
'Central Bank (CB)'	means the European Central Bank (ECB), the euro area NCBs and the non-euro area NCBs.
'Central Bank Money (CeBM)'	means the liabilities of a Central Bank, in the form of either banknotes or bank deposits held at a Central Bank, which can be used for settlement purposes.
'Central Securities Depository (CSD)'	has the meaning set out in Article 2(1)(1) of Regulation (EU) No 909/2014.
'Change and Release Management (CRM)'	means the set of rules used and the activities performed when a Change Request, as described in Schedule 9 (Change and Release Management) is initiated and until it is rejected or the change is implemented into the production environment.
'Change Management'	means the processes used and the activities performed when a Change Request as described in Schedule 9 (Change and Release Management) is initiated and until it is rejected or authorised for implementation.
'Change Request'	means a request of a contracting party for a change that is subject to the Change and Release Management process, as described in Schedule 9 (Change and Release Management).
'Change Review Group (CRG)'	means the group established by the T2S Steering Level and composed of the relevant T2S Actors mandated to analyse Change Requests and make proposals on the content of T2S releases, as further specified in Schedule 9 (Change and Release Management).
'Collective Agreement'	means the agreement concluded on 8 January 2018 between the Central Banks operating TARGET component systems, the non-euro area NCB in T2S and the Signatory CSDs.
'Common Change'	means a change implemented for the benefit of all T2S Actors as described in Schedule 9 (Change and Release Management).

T2S Framework Agreement

Schedule 1 – Definitions

'Common Components'	means a set of hardware, software and other technical infrastructure elements available for use by more than one TARGET Service for the purposes of one or more functionalities. In the TARGET2-Securities environment, the Common Components used to deliver the functionalities are indicated in the T2S Operational Governance Process Framework, which is listed in Schedule 8 Annex 2 of the T2S FA and T2S CPA as a T2S deliverable.
'Common Reference Data'	means the business information, which is available to all T2S Actors and which T2S requires to process business operations. This includes but is not limited to processing schedules, system entities, the SWIFT BIC Directory, system configuration data, attribute domains that are not specific to a CSD or Central Bank and standardised roles and privileges from which CSDs and Central Banks can configure their specific roles and access rights for their system users.
'Concession Contract'	means each of the two contracts between the Eurosystem and the selected NSPs granting the latter a 10-year concession for the provision of connectivity services via the Eurosystem Single Market Infrastructure Gateway to the TARGET Services.
'Conditional Participation Fee'	means the fee of EUR 50,000.00 that the Contracting CSD is due to pay to the Eurosystem upon signing the T2S FA for the support related to the activities necessary for completing its Migration to the T2S Platform.

T2S Framework Agreement

Schedule 1 – Definitions

'Confidential Information'	means any information, data, documentation or material that includes trade and business secrets, know-how and information regarding the business, strategy, financial situation, products and prospects, processes and methodologies, customers, suppliers and employees, systems, programs, algorithms, source codes, technical and security requirements and specifications (including any information that any party is obliged to keep confidential according to a contractual agreement or by law), and any other information, material or documentation (in each case to the extent marked as confidential or with a similar designation, or which a reasonable person would consider as confidential) related to a party or its Affiliates, which such a party has disclosed (in whatever form) to the other party in connection with this Agreement. Confidential Information does not include information that: (a) has been designated by a party as being intended for disclosure to Third Parties and does not reveal Confidential Information received by another party; (b) becomes generally available to the public other than as a result of a breach of the confidentiality obligations under this Agreement; or (c) is received from a Third Party not bound by an obligation of confidentiality with respect to such information (while the receiving party is aware or made aware by the other party of this fact); (d) was known to or legally in a party's possession without obligations of confidentiality prior to such information being provided as Confidential Information in accordance with this Agreement; or (e) is developed by either party (or its Affiliates or their employees or representatives) independently without the use of Confidential Information of the other party.
'Connectivity Services'	means any or all of the following services: (i) the Physical Connectivity Services, (ii) the messaging services, (iii) the security services and (iv) the operational services, as specified in the attachment 1.1 (technical requirements) to the Concession Contract.
'Contracting CSD'	means the specific CSD which enters into this Agreement with the Eurosystem.
'Cost Recovery Period'	means the time frame determined by the Governing Council for the full recovery of the costs undertaken by the Eurosystem to (i) set-up the T2S platform (T2S realisation costs); and (ii) regularly operate and maintain it (T2S operational costs), via fees to be levied from the T2S Actors. The Cost Recovery Period started on the T2S Go-Live Date.
'CPMI-IOSCO Principles for Financial Market Infrastructures'	means the international standards published in April 2012 by the Committee on Payment and Settlement Systems and the Board of the International Organization of Securities Commissions for payment systems that are systemically important, central securities depositories, securities settlement systems, central counterparties and trade repositories.

T2S Framework Agreement

Schedule 1 – Definitions

'Crisis' or 'Crisis Situation'	means a situation that requires the involvement of the senior manager of the Contracting CSD (referred to as CSD crisis manager in Schedule 6 [T2S Service Level agreement]), in order to manage a severe technical Incident or market disturbance, either in accordance with the requirements specified in the MOP or because the procedures described in the MOP are not sufficient to effectively handle the situation.
'CSD Reference Data'	means the business information, specific to a CSD in T2S that T2S requires to process the Transactional Data related to that CSD. This includes but is not limited to T2S system users, conditional securities parameters, message subscriptions, attribute domains that are specific to the CSD or relevant Central Bank, report subscriptions, securities account reference data, party reference data, cross-CSD settlement parameterisation, assignment of securities accounts to limits, and CSD-specific attributes for Securities Reference Data.
'T2S CSD Steering Group (T2S CSG)'	means the T2S governance body which, with respect to a set of matters stipulated in this Agreement, is part of the T2S Steering Level and makes resolutions and delivers opinions on behalf of the Contracting CSD and the Participating CSDs. The Mandate of the T2S CSG is annexed to Schedule 8 (Governance).
'CSDs' Acceptance Tests of the T2S Services'	means the process whereby the Contracting CSD assesses the compliance of the T2S Services with Schedule 5 (T2S Service Description) and the T2S Scope Defining Set of Documents as further specified in Schedule 3 (User Testing).
'Customer Claim'	has the meaning set out in Article 32(3) of this Agreement.
'Decision ECB/2019/166'	means Decision (EU) 2019/166 of the European Central Bank of 25 January 2019 on the Market Infrastructure Board, repealing Decision ECB/2012/6 on the establishment of the TARGET2-Securities Board ECB/2019/3 (OJ L 32, 4.2.2019, p. 14–31).
'Decision ECB/2011/20'	means Decision ECB/2011/20 of 16 November 2011 establishing detailed rules and procedures for implementing the eligibility criteria for central securities depositories to access TARGET2-Securities services (OJ L 319, 02/12/2011, p. 0117-0123), as amended.
'T2S Dedicated Cash Account (T2S DCA)'	means a cash account in T2S operated by a Central Bank.
'Delivery versus Payment (DvP)'	means a securities settlement mechanism, which links a securities transfer and a funds transfer in such a way as to ensure that delivery occurs if – and only if – the corresponding payment occurs.
'Directive 98/26/EC'	means Directive 98/26/EC of the European Parliament and of the Council of 19 May 1998 on settlement finality in payment and securities settlement systems (OJ L 166, 11.6.1998, p. 45), as amended.

T2S Framework Agreement

Schedule 1 – Definitions

‘Direct Loss’	has the meaning set out in Article 32(2) of this Agreement.
‘Directly Connected Party (DCP)’	means a T2S User, which has been authorised by its Contracting CSD or Central Bank to access T2S directly to use T2S Services, i.e. without the need for the Contracting CSD to act as a technical interface.
‘Directly Connected T2S Actor’ or ‘DiCoA’	means either the Contracting CSD or any of the Signatory CSDs, or any of the non-euro area NCBs, or any of the DCPs.
‘Dynamic Data’	see ‘Transactional Data’.
‘Enforceable Judgement’	means a binding and enforceable judgment or equivalent type of decision rendered by a court or award rendered by an arbitral tribunal.
‘euro area NCB’	means the NCB of a European Union Member State whose currency is the euro.
‘European System of Central Banks (ESCB)’	means, in accordance with Article 282(1) of the Treaty on the Functioning of the European Union, the System constituted by the ECB and the NCBs of the European Union Member States.
‘Eurosystem’	means, in accordance with Article 1 of the Statute of the ESCB and of the European Central Bank, the ECB and the NCBs of the European Union Member States whose currency is the euro.
‘Eurosysteem Acceptance Testing (EAT)’	means the formal testing conducted by the Eurosysteem to determine whether the T2S Platform is compliant with the T2S Scope Defining Set of Documents.
‘Exit Management’	means the set of rules and procedures applied on termination of the Agreement, howsoever caused, as described in Schedule 11 (Exit Management).
‘External Examiner’	means a well-reputed, internationally active auditing firm that has the tasks set out in Article 26 of this Agreement assigned to it.
‘Fast-track Changes’	means changes that are imposed by Legal and Regulatory Requirements, or by T2S CSG resolutions related to risk management, or changes that are critical for the stability of the T2S Platform or by Central Bank decisions related to safeguarding the currency/-ies or related to crisis management measures to ensure financial stability and that, owing to the time constraints, have to be implemented in a shorter timeframe than normal, which will be decided on an ad-hoc basis, as specified in Schedule 9 (Change and Release Management).

T2S Framework Agreement

Schedule 1 – Definitions

'Force Majeure'	means any circumstances beyond the reasonable control of the non-performing contracting party, including, without limitation, an element of nature or an act of God, earthquake, fire, flood, war, terrorism, civil, industrial or military disturbance, sabotage, labour strike or lock-outs, pandemic, epidemic, riot, loss or malfunction of utilities or communication services, court order, act of civil or military authority, or governmental, judicial or regulatory action.
'Free of Payment (FoP)'	means the delivery of securities with no corresponding payment.
'General Specifications (GS)'	means together with the GFS and the GTD, the document that describes how the Eurosystem envisages implementing the URD. In particular, the General Specifications focus on those user requirements that do not have a functional or technical dimension, such as operational support, testing, migration and Information Security.
'General Functional Specifications (GFS)'	means a general functional description of the T2S Business Application to be developed to comply with the URD. It will include elements such as the functional architecture (domains, modules and interactions), the conceptual models, the data model or the data flow process.
'Governance'	means the set of rules and procedures concerning the management of T2S Services, including the related decision-making of the parties involved in T2S, as specified in Schedule 8 (Governance).
'Governing Council'	means the decision-making body of the ECB comprising the members of the Executive Board of the ECB and the governors of the euro area NCBs, as provided for in Article 10 of the Statute of the ESCB.
'General Technical Design (GTD)'	means the document that details the solution envisaged for the T2S non-functional requirements, more specifically with regard to the application design and the infrastructure design.
'Graphical User Interface (GUI)'	means the interface that allows a user to interact with a software application through the use of graphical elements (e.g. windows, menus, buttons and icons) on a computer screen using the keyboard and the mouse.
'Guideline ECB/2012/13'	means Guideline ECB/2012/13 of 18 July 2012 on TARGET2-Securities (OJ L 215, 11.8.2012, p. 19), and repealing Guideline ECB/2010/2, as amended.
'Incident'	means an event which is not part of the standard operation of the T2S Service and which causes, or may cause, an interruption or a reduction of the quality of that service. Incidents must be resolved immediately and are not part of the Change and Release Management.

T2S Framework Agreement

Schedule 1 – Definitions

'Information Security'	means the preservation of the integrity, confidentiality and availability as well as other attributes which may be relevant such as authenticity, accountability, non-repudiation and reliability of the T2S information and T2S Services, as set out in the International Organisation for Standardisation ('ISO') Standard 27000:2018, as the latter is amended or replaced from time to time.
'Information Technology Infrastructure Library (ITIL)'	means the set of best practices for managing IT infrastructure, development and operations, maintained under the auspices of the Office of Government Commerce, an office of the UK Treasury.
'Insolvency Event'	means a collective judicial or administrative proceeding, including an interim proceeding, in which the assets and affairs of the Contracting CSD are subject to control or supervision by a court or other competent authority for the purpose of reorganisation, winding up or liquidation.
'Intellectual Property Rights (IPRs)'	means any patents, utility models, designs, trademarks, copyrights (each of the foregoing, to the extent applicable, registered, applied for or unregistered), inventions whether or not patentable, database rights, know-how and all rights having equivalent or similar effect in any jurisdiction.
'Intended Settlement Date (ISD)'	means the date on which the parties to a securities transaction agree that settlement is to take place. The ISD is also referred to as the contractual settlement date or value date.
'International Securities Identification Number (ISIN)'	means the number, which uniquely identifies a security. Its structure is defined in ISO 6166.
'Investor CSD'	means a CSD that holds a security for which it is not the/an Issuer CSD. It holds these securities either directly or indirectly, via one or more intermediaries, at the/an Issuer CSD.
'Issuer CSD'	means a CSD, which holds a primary deposit in the relevant securities, either in dematerialised or physical form.
'Joint Controllers'	has the meaning set out in Annex 3 to Schedule 8.
'Key Performance Indicator(s) (KPI(s))'	means a metric used to quantify the performance of the Eurosystem and to monitor compliance with Schedule 6 (the T2S Service Level Agreement).
'Lean Scope of T2S'	means the scope of T2S defined by the URD resulting from the market involvement and is restricted by the general principles of T2S, as referenced in the URD.
'Legal and Regulatory Requirements'	means all applicable requirements that a Contracting CSD and the Eurosystem must comply with, including those of a legal, regulatory (including fiscal), supervisory and oversight nature and that are relevant in the context of T2S.
'Maintenance Window'	means the period for system maintenance during which T2S is planned to be unavailable, as defined in Schedule 6 (T2S Service Level Agreement).

T2S Framework Agreement

Schedule 1 – Definitions

‘Manual of Operational Procedures (MOP)’	means the document that describes the procedures to be applied by all T2S Actors, aimed at ensuring the smooth conduct of daily operations and at minimising the duration and impact of service interruptions or deteriorations.
‘Market Infrastructure Board (MIB)’	means the Eurosystem governance management body, whose mandate and composition are set out in Decision ECB/2019/166.
‘Matching’	means the process used for comparing the settlement details provided by parties in order to ensure that they agree on the terms of the transaction.
‘Migration’	means the relocation of data from a CSD to the T2S Platform and the associated changes in the processes and technical environment of a CSD on the Migration Date.
‘Migration Date’	means the specific date, mutually agreed by the Parties and defined in Annex 1 to Schedule 4, on which the Contracting CSD is to complete its Migration to the T2S Platform.
‘Multilateral Character of T2S’	has the meaning set out in Article 4 of this Agreement.
‘Network Service Provider (NSP)’	means an undertaking that has been awarded a Concession Contract with the Eurosystem to provide connectivity services via the Eurosystem Single Market Infrastructure Gateway to the TARGET Services.
‘non-euro area NCB’	means the NCB of a European Union Member State, whose currency is not the euro, or of a country that is outside the European Union.
‘T2S Non-euro Currencies Steering Group (T2S NECSG)’	means the T2S governance body which, with respect to a set of matters stipulated in the T2S CPAs, makes resolutions and delivers opinions on behalf of the non-euro area NCBs in T2S. The Mandate of the T2S NECSG is annexed to Schedule 8 (Governance) of the T2S CPA.
‘non-euro area NCB(s) in T2S’	means the non-euro area NCB(s) that has/have signed the T2S Currency Participation Agreement.
‘Operations Managers Group (OMG)’	means the group established by the T2S Steering Level and composed of the relevant T2S Actors that develops and maintains the Manual of Operational Procedures, meets to review the T2S service performance against the Service Level Agreement and coordinates the management of operational Incidents, as specified in Schedule 6 (T2S Service Level Agreement).
‘Operational Phase’	means the period when the full scope of T2S Services are operational in the T2S production environment, and beginning on the T2S Go-Live Date.
‘Other T2S Specification Documents’	means the set of documents, when added to the T2S Scope Defining Set of Documents, that provide a full description of T2S.
‘Parallel T2S Framework Agreement’	means an agreement essentially identical, save for the identity of the parties to the agreement entered into between a Participating CSD and the Eurosystem.

T2S Framework Agreement

Schedule 1 – Definitions

‘Participating CSD(s)’	means the CSD(s) other than the Contracting CSD that have signed this Agreement.
‘Payment Bank’	means a commercial bank used to effect money settlements. In the context of securities settlement, a Payment Bank provides cash on behalf of a CSD participant to support the settlement of securities.
‘Payment Free of Delivery (PFoD)’	means a transfer of cash without the delivery of securities.
‘Physical Connectivity Services’	means the implementing, maintaining and keeping available of a data communication network for the purpose of exchanging files and messages between the Directly Connected T2S Actors and the Eurosystem Single Market Infrastructure Gateway, as more specifically described in the Concession Contract.
‘Pricing’	means the set of rules and procedures that is applied to price the T2S Services and T2S-related services provided by the Eurosystem, as described in Schedule 7 (Pricing).
‘Project Managers Group (PMG)’	means the group established by the T2S Steering Level and composed of the relevant T2S Actors that coordinates and monitors activities and releases of T2S, as specified in Schedule 3 (User Testing) 4 (Migration) and 9 (Change and Release Management).
‘Real-time Settlement’	means the continuous process in T2S that settles or attempts to settle instructions that are eligible for settlement on a transaction-by-transaction basis.
‘Regulation (EU) No 909/2014’	means Regulation (EU) No 909/2014 of the European Parliament and of the Council of 23 July 2014 on improving securities settlement in the European Union and on central securities depositories and amending Directives 98/26/EC and 2014/65/EU and Regulation (EU) No 236/2012 (OJ L 257, 28.8.2014, p. 1), also referred to as ‘CSDR’.
‘Regulation (EU) No 2016/679’ or ‘GDPR’	means Regulation (EU) 2016/679 of the European Parliament and of the Council of 27 April 2016 on the protection of natural persons with regard to the processing of personal data and on the free movement of such data, and repealing Directive 95/46/EC (General Data Protection Regulation) (OJ L 119, 4.5.2016, p. 1–88), also referred to as ‘GDPR’.
‘Regulation (EU) No 2018/1725’ or ‘EUDPR’	means Regulation (EU) 2018/1725 of the European Parliament and of the Council of 23 October 2018 on the protection of natural persons with regard to the processing of personal data by the European Union institutions, bodies, offices and agencies and on the free movement of such data, and repealing Regulation (EC) No 45/2001 and Decision No 1247/2002/EC (OJ L 295, 21.11.2018, p. 39–98), also referred to as ‘EUDPR’.

T2S Framework Agreement

Schedule 1 – Definitions

‘Release Management’	means the set of rules used and the activities performed to implement a set of authorised changes and defect corrections in a new version of the T2S Business Application, as set out in Schedule 9 (Change and Release Management).
‘Relevant Competent Authority’	means any organisation having regulatory, supervisory or oversight authority over the Contracting CSD or a Participating CSD (as required by the context).
‘Schedule’	means a Schedule to this Agreement.
‘Securities Account’	means an account maintained by a CSD to which securities may be credited or debited.
‘Securities Maintaining Entity (SME)’	means an entity, typically a CSD that has been assigned the responsibility for maintaining the reference data for a security in T2S.
‘Securities Reference Data’	means the business information for a financial instrument, excluding any CSD-specific attributes, that is under the responsibility of the SME and available to all Participating CSDs, that T2S stores and requires for processing settlement instructions-related operations, including the calculation of cash penalties in the context of the T2S Penalty Mechanism service.
‘Securities Settlement System’	means a system as defined in Article 2(a) of Directive 98/26/EC for the execution of transfer orders related to title to or interest in a security or securities by means of a book entry on a register or otherwise.
‘Service Level’	means the level of performance of a T2S Service, that Schedule 6 (T2S Service Level Agreement) specifies and that the Signatory CSDs requires to deliver its services to its customers.
‘Service Level Report’	means the monthly report made available by the Eurosystem to the Contracting CSD to determine the degree of the Eurosystem’s compliance with the Service Level Agreement, as specified in Schedule 6 (T2S Service Level Agreement), in particular as regards the KPIs.
‘Settlement Day’	means a day on which T2S settlement takes place according to the daily processing schedule.
‘Signatory CSDs’	means the CSDs that have entered into the T2S FA with the Eurosystem, i.e. the Contracting CSD and the Participating CSDs.
‘Specific Change’	means any new feature, functionality or service – or any amendment of an existing feature, functionality or service – which is not implemented as a Common Change (within the applicable Governance arrangements), but which some Participating CSDs and/or Central Banks wish to implement, provided that it is compliant with the Lean Scope of T2S, and for which they jointly accept to bear the investment and running costs.

T2S Framework Agreement

Schedule 1 – Definitions

‘Statute of the ESCB’	means the Statute of the European System of Central Banks and of the European Central Bank (Protocol No 4 to the Treaty on the Functioning of the European Union, OJ C 83, 30.3.2010, p. 230).
‘Suspension’	means the temporary freezing – possibly limited to the T2S Services relevant to the cause of suspension – of the rights and obligations of the Contracting CSD for a period of time to be determined by the Eurosystem, as described in Article 35.
‘T2S Actor’	means either the Contracting CSD, a Participating CSD, CSD participant (a legal entity or, as the case may be, an individual) having a contractual relationship with the CSD for the processing of its securities settlement-related activities in T2S, or a Central Bank, whose currency is available for settlement-related processing in T2S, or a member of a Central Bank having a contractual relationship with the Central Bank for the processing of its settlement-related cash-processing activities in T2S.
‘T2S Business Application’	means the software developed and operated by the 4CB on behalf of the Eurosystem with a view to enabling the Eurosystem to provide the T2S Services on the T2S Platform.
‘T2S Currency Participation Agreement (T2S CPA)’	means each of the agreements to be entered into by the Eurosystem and a non-euro area NCB in T2S or another authority responsible for a non-euro currency, to allow for securities settlement in CeBM in the non-euro currency they are responsible for.
‘T2S Documentation’	means the T2S non-scope defining set of documents that consists of the Other T2S Specification Documents, the T2S Operational Phase Documents and the T2S Project Documents as described in Schedule 2 Annex 8 (T2S Deliverables List and Management Process).
‘T2S Framework Agreement’	see ‘Agreement’.
‘T2S Go-Live Date’	means 22 June 2015, which represents the first Settlement Day after which the first Signatory CSDs have migrated to T2S.
‘T2S Memorandum of Understanding’	means the Memorandum of Understanding concluded on 16 July 2009 between the Eurosystem and the first Signatory CSDs, as well as other European CSDs, showing the commitment towards T2S and setting out the mutual obligations and responsibilities for the time frame up to the conclusion of a definitive agreement.
‘T2S Operator’	means the legal and/or organisational entity/entities that operates/operate the T2S Platform. As part of an internal distribution of work within the Eurosystem, the Governing Council entrusted the 4CB with operating T2S on behalf of the Eurosystem.

T2S Framework Agreement

Schedule 1 – Definitions

'T2S Operational Phase Documents'	means the set of documents that describes how T2S provides its services in production. It encompasses the documentation for T2S as a software application and the manuals describing the rules and procedures for operating T2S.
'T2S Penalty Mechanism Service'	means the T2S procedure to facilitate and promote timely settlement of transactions and consists of the following three service components: (i) cash penalties identification service; (ii) cash penalties computation service; and (iii) cash penalties adjustment service.
'T2S Platform' or 'TARGET2-Securities (T2S)'	see 'TARGET2-Securities (T2S)'.
'T2S Programme'	means the set of related activities and deliverables needed to develop T2S until the full migration of all CSDs which have signed this Agreement and all Eurosystem Central Banks and non-euro area NCBs in T2S.
'T2S Programme Plan'	means the common Eurosystem-CSD-Central Bank plan, outlining the milestones and timelines to deliver the T2S Programme as well as the actions and contributions required from the Eurosystem, the CSDs and other T2S Stakeholders.
'T2S Project Documents'	means the set of documents required for planning, monitoring and successfully completing the scheduled activities (e.g. User Testing, Migration, client readiness tracking) in the T2S project lifecycle but not during the Operational Phase, i.e. from the start of the T2S Programme until T2S is live, or during any subsequent preparation for releases.
'T2S Scope Defining Set of Documents'	means the set of documents defining the scope of T2S composed of the User Requirements Document (URD), the User Detailed Functional Specifications (UDFS), User Handbook (UHB) of the software components delivering the T2S Services, including the Common Components, the Graphical User Interface (GUI) Business Functionalities, General Functional Specification (GFS) and the Data Migration Tool File Specifications.
'T2S Services'	means the services to be provided by the Eurosystem to the Contracting CSD as specified in this Agreement
'T2S Service Level Agreement (SLA)'	means the agreement defining the Service Levels, measured against agreed KPIs where relevant, to be provided by the Eurosystem to the CSDs, as specified in Schedule 6 (T2S Service Level Agreement) and in relation to T2S Services.
'T2S Service Description'	means the description of the T2S Services, contained in Schedule 5 (T2S Service Description).
'T2S Stakeholder'	means any organisation, legal entity or governmental entity, public or private interest groups, or individual that has a valid interest in the T2S Service and the governance and operation of T2S.

T2S Framework Agreement

Schedule 1 – Definitions

‘T2S Steering Level’	means the level comprising the MIB for tasks delegated by the Governing Council, the T2S CSG and the T2S NECSG, as specified in Schedule 8 (Governance).
‘T2S User’ or ‘User’	see ‘User’.
‘TARGET’	means the payment system composed of the TARGET component systems functioning in accordance with Guideline ECB/2022/8 (EU) 2022/08) of 24 February 2022 on a new generation Trans-European Automated Real-time Gross Settlement Express Transfer system (TARGET) and repealing Guideline ECB/2012/27.
‘TARGET2-Securities (T2S)’ or ‘T2S Platform’	means the set of hardware, software and other technical infrastructure components through which the Eurosystem provides the services to CSDs that allow core, neutral and borderless settlement of securities transactions on a DvP basis in Central Bank Money.
‘Technical Disconnection’	means the action motivated by an imminent threat to the security or availability of the T2S Platform, whereby the Eurosystem, in its capacity of operator of T2S, technically blocks the access to the T2S Platform for one or more Directly Connected T2S Actors until such threat has been neutralised.
‘Technical Group(s)’	means the technical groups established by the T2S Governance bodies with a supporting role, in accordance with Schedule 8 (Governance).
‘Technical Issuer CSD’	means a CSD where the security holdings of the participants of an Investor CSD are deposited.
‘Third Party’	means individual or legal entity, which is not party to this Agreement. For the avoidance of doubt, a Third Party is a person or legal entity other than the Contracting CSD, the ECB, the euro area NCBs or the T2S Operator.
‘Transactional Data’	means the information that T2S creates and stores through the execution of a business process event, where the content of the information defines that event. This includes but is not limited to inbound and outbound XML messages, all types of settlement instructions and all data that T2S generates for the life cycle of the instruction (e.g. securities positions) and reference data maintenance instructions. This is also referred to as Dynamic Data in the Schedules and in other documentation.
‘Transfer Order’	has the meaning set out in article 2(i) of Directive 98/26/CE.
‘Treaty on the Functioning of the European Union (TFEU)’	means the Treaty on the Functioning of the European Union (OJ C 83, 30.3.2010, p. 47).

T2S Framework Agreement

Schedule 1 – Definitions

'User Detailed Functional Specifications (UDFS)'	means a detailed description of the functions managing the T2S external data flows (from A2A). It will include the necessary information for the users to adjust or to develop their internal information systems with a view to connecting them to T2S.
'User Handbook (UHB)'	means the document describing the way in which T2S Users can make use of a number of T2S software functions that are available in a U2A (screen- based) mode.
'User Requirements Document (URD)'	means the document setting out the user requirements for T2S as published by the ECB on 3 July 2008 and as subsequently amended through the T2S change and release management procedure.
'User' or 'T2S User'	means a CSD participant (a legal entity or, as the case may be, an individual) having a contractual relationship with the CSD for the processing of its securities settlement-related activities in T2S, or a member of a Central Bank (whose currency is available for settlement-related processing in T2S) having a contractual relationship with the Central Bank for the processing of its securities settlement-related cash-processing activities in T2S.
'User Testing ' or 'User Tests'	means a set of rules and procedures concerning the testing of T2S by CSDs as described in Schedule 3 (User Testing).
'User-to-Application ('U2A)'	means a connectivity mode to exchange information between software applications of T2S and a T2S Actor through a GUI.



EUROPEAN CENTRAL BANK

EUROSYSTEM

T2S FRAMEWORK AGREEMENT

SCHEDULE 2

INTENTIONALLY LEFT BLANK



EUROPEAN CENTRAL BANK

EUROSYSTEM

T2S FRAMEWORK AGREEMENT

SCHEDULE 2

ANNEXES

INTENTIONALLY LEFT BLANK



EUROPEAN CENTRAL BANK

EUROSYSTEM

T2S FRAMEWORK AGREEMENT

SCHEDULE 3 USER TESTING

T2S Framework Agreement

Schedule 3 – User Testing

1	INTRODUCTION	3
2	SCOPE AND OBJECTIVES	3
2.1	Scope	3
2.2	Objectives	3
3	GENERAL RESPONSIBILITIES OF THE PARTIES	4
3.1	General responsibilities of the Eurosystem.....	4
3.2	General responsibilities of the Contracting CSD	5
3.3	General responsibilities of the PMG Substructure	5
4	USER TESTING PREPARATION PHASE IN VIEW OF A MIGRATION	6
5	USER TESTING EXECUTION PHASE IN VIEW OF A MIGRATION	7
5.1	Testing Stage Organisation	7
5.2	Connectivity Testing Stage	7
5.3	Bilateral Interoperability Testing Stage	7
5.4	Community Testing Stage.....	8
5.4.1	Description.....	8
5.4.2	DCP Certification	8
5.5	Business Day Testing Stage.....	9
6	NON-FUNCTIONAL TESTS	10
6.1	Description.....	10
6.2	Objectives and responsibilities of performance and stress tests	10
6.3	Objectives and responsibilities of Business Continuity tests	11
6.4	Objectives and responsibilities of Security Tests	12
6.5	Performance Tests by CSDs	12
7	USER TESTING IN VIEW OF A RELEASE DEPLOYMENT	12

T2S Framework Agreement

Schedule 3 – User Testing

1 Introduction

The Signatory CSDs and the Eurosystem shall cooperate in good faith for the preparation and execution of all User Testing activities for new software releases and Migration.

2 Scope and Objectives

2.1 Scope

The scope of User Testing comprises functional testing and non-functional testing that the Contracting CSD and its community perform in view of assessing:

- the ability to connect to T2S (connectivity testing);
- the compliance of T2S with the T2S Services as defined in Schedule 5 (T2S Service Description) and the T2S Scope Defining Set of Documents;
- the ability to interact properly with T2S without negative impact on the T2S Platform or other connected T2S Actors (DCP certification);
- the ability to migrate CSD Reference Data and Transactional Data from its legacy systems onto T2S (migration testing, mainly assessed during bilateral interoperability testing and community testing);
- the ability to extract CSD Reference Data and Transactional Data from T2S for reverse migration; and
- the readiness of operational procedures for live operations.

Although the functional and non-functional tests that the Eurosystem performs – including the Eurosystem Acceptance Testing (EAT) – do not fall into the scope of User Testing, evidence provided through these tests may be used on a discretionary basis by the Signatory CSDs as a means to limit their efforts during User Testing.

2.2 Objectives

The objectives of the User Testing are:

- to provide evidence that the T2S Platform meets the User requirements, as defined by the most recently approved version of the most detailed documents of the T2S Scope Defining Set of

T2S Framework Agreement

Schedule 3 – User Testing

Documents and Schedule 5 (T2S Service Description);

- to ensure readiness of the Contracting CSD and its community as well as its Central Bank and Payment Banks for the Migration to and operation on the T2S Platform; and
- to allow the Contracting CSD to verify and ensure its compliance with Legal and Regulatory Requirements.

3 General responsibilities of the Parties

3.1 General responsibilities of the Eurosystem

With regard to the preparation and execution and completion of the User Testing activities, the Eurosystem shall:

- a) coordinate the User Testing activities and communication between the Contracting CSD and the Central Banks whose currencies are available for settlement in T2S as well as between the Signatory CSDs involved in the User Testing activities;
- b) take all necessary actions to facilitate, monitor and support the adequate participation of the Central Banks whose currency is available for settlement in T2S in the testing activities of the Contracting CSD;
- c) provide the adequate support for testing activities of the Contracting CSD in the different stages of User Testing;
- d) inform the Contracting CSD, in a timely manner, about any developments that may prevent that CSD or its DCP(s) from completing its/their testing activities, and shall propose identified mitigation measures;
- e) ensure that a PMG substructure is in place, in accordance with the T2S governance framework (Schedule 8 - Governance), for the planning, coordination and monitoring of the User Testing activities; reconcile and consolidate the individual status reports of Signatory CSDs and Central Banks on the progress of their User Testing activities and provide a regular status update based on this consolidation to the Contracting CSD;
- f) investigate and reconcile test outcomes by Signatory CSDs or DCPs for delivering a consolidated list of defects to the PMG;

T2S Framework Agreement

Schedule 3 – User Testing

- g) undertake the configuration of test environments as agreed with the relevant Technical groups;
- h) maintain configuration parameters and the User Testing Calendar (Settlement Day calendar, operating hours, cut-off times, etc.) for each test environment as agreed with the relevant Technical Groups;
- i) establish and operate the necessary IT service management processes that include a defect resolution process to remedy errors, based on the principles of ITIL;
- j) operate T2S in accordance with the SLAs for User Testing as defined in Schedule 6 (T2S Service Level Agreement)..

3.2 General responsibilities of the Contracting CSD

For the preparation and execution of the User Testing activities, the Contracting CSD shall:

- a) be responsible for the communication with its community regarding User Testing;
- b) ensure the timely completion of all its testing activities and shall report its findings on the execution of its test cases and test scenarios to the Eurosystem on a regular basis;
- c) support and monitor the timely completion of the testing activities of its community, and specifically of its DCPs;
- d) support other Signatory CSDs and CBs in testing of T2S;
- e) inform the Eurosystem, in a timely manner, about any developments, which may prevent it or its DCP(s) from completing its/their testing activities;
- f) participate in the Technical Groups as required to support the proper functioning of T2S testing activities and the smooth coordination of the User Testing activities.

3.3 General responsibilities of the PMG Substructure

The PMG substructure shall be composed of the Participating CSDs, euro area NCBs, non-euro area NCBs in T2S, the 4CB and the ECB. The following specifies the general responsibilities of the PMG substructure in the preparation and execution of the User Testing activities for new software releases and Migration that the substructure shall be responsible for:

T2S Framework Agreement

Schedule 3 – User Testing

- a) Meeting (physically or via conference call) on a regular basis and on an ad hoc basis when requested by one of the members to prepare, plan, coordinate, monitor and review User Testing activities. The PMG substructure determines the frequency of its meetings based on its needs;
- b) Preparing, updating and agreeing the User Testing Calendar;
- c) Discussing on changes to the opening / closing times of the testing environments and operational hours in line with the provisions of the SLA;
- d) Reviewing the consolidated User Testing status ;
- e) Reviewing the list of Incidents;
- f) Reviewing the software defects, classify the software defects and agree on the contents of a package for a T2S release on the User Testing environments;
- g) In the case that the PMG substructure cannot reach an agreement, it may escalate to the PMG;
- h) Preparing communication on the progress of User Testing via the PMG to the T2S Steering Level;
- i) Coordinating and monitoring the participation of the various T2S Actors during the different stages of testing. At its own discretion, the Contracting CSD may coordinate testing activities directly with other T2S Actors when it does not conflict with the agreed approach of the PMG substructure;
- j) Identifying, managing, reporting and escalating risks and issues related to User Testing;
- k) Taking or requesting decisions on User Testing related topics according to the decision-making process defined in Schedule 8 (Governance) and Schedule 9 (Change and Release Management).

4 User Testing Preparation Phase in view of a Migration

The objective of the User Testing preparation phase is to:

- organise processes and activities required for the User Testing execution phase, as defined in section 4 of this Schedule;
- undertake an initial risk assessment for the User Testing execution phase to ensure the subsequent proactive risk management by the PMG substructure;
- prepare and design all necessary test documentation and testing processes, e.g. User Testing

T2S Framework Agreement

Schedule 3 – User Testing

calendar, test data.

In this preparation phase for User Testing, the Eurosystem with the support of the Contracting CSD through its participation in the PMG substructure for User Testing establishes the required process framework and prepares the agreed deliverables for the User Testing execution phase.

5 User Testing Execution Phase in view of a Migration

This section describes the structure of the testing stages for User Testing execution for a contracting CSD migrating into T2S.

5.1 Testing Stage Organisation

The User Testing execution phase consists of both independent and sequenced testing stages. The purpose of the different testing stages is to increase gradually the number of T2S Actors involved and expand the scope of the testing.

5.2 Connectivity Testing Stage

Establishing the technical connectivity to a test environment is the first stage of User Testing. This is required for each environment that the Contracting CSD uses for testing, however, the connectivity testing stage is the initial verification that the systems of both the Contracting CSD and the Eurosystem can communicate successfully on the technical and application level. The Contracting CSD shall repeat these tests for each connectivity channel it intends to use while the connection to further T2S test environments might have a reduced connectivity test scope.

The scope of connectivity testing consists of:

- testing the ability to reach the welcome pages of the U2A interface and performing the login to the system;
- exchange of messages on application level;
- push-and-pull services for reports.

5.3 Bilateral Interoperability Testing Stage

In the bilateral interoperability testing stage, the Contracting CSD tests T2S to ensure the readiness of

T2S Framework Agreement

Schedule 3 – User Testing

its adapted IT system to interoperate with T2S and verifies that all T2S Services in T2S are working as required. It undertakes its testing without interacting with other Participating CSDs and Central Banks. T2S ensures the segregation of the testing activities of the Contracting CSD from other CSDs' test activities on T2S. The objective of this testing stage is to ensure that the CSDs' adapted IT system can interoperate with T2S properly. A CSD can continue performing bilateral testing even when it undertakes Community testing.

5.4 Community Testing Stage

5.4.1 Description

The community testing stage is the stage in which the Contracting CSD executes multilateral testing activities with other Participating CSDs and Central Banks to its community, i.e. the group of T2S Users having a contractual relationship with the Contracting CSD. The main objective of this stage is to validate that the Contracting CSD's participants can interact correctly end-to-end with T2S, either through the Contracting CSD's adapted systems or with T2S directly as DCP.

During the testing stage CSDs and their communities verify the correct functioning of T2S using the TARGET data configuration as configured for the TARGET production environment. The expectation is that processing errors will stem mainly from incorrect data configurations, allowing the Contracting CSD to identify and correct such incorrect configurations, and from DCPs' testing of their interface to T2S. This stage represents the first opportunity of the Contracting CSD's participants to test with T2S, allowing the CSD's participants to verify that their system interoperate correctly with T2S.

The community testing stage allows the Contracting CSD and its community to familiarise themselves with operational procedures and service management relevant to this stage to ensure that the operational procedures as described in the Manual of Operational Procedures (MOP) are working as expected.

5.4.2 DCP Certification

The DCP certification aims at providing evidence by the participant of the Contracting CSD that its adapted IT platform does not harm T2S as the result of inappropriate technical communication or procedures. DCP certification does not verify the compliance with either the Contracting CSD's adaptation to T2S nor with the Contracting CSD's business processing requirements. When conducted

T2S Framework Agreement

Schedule 3 – User Testing

during the User Testing execution phase, it runs in parallel to the community testing stage for those participants of the Contracting CSD that request to connect directly to T2S. Participants of the Contracting CSD also have the option to undertake their DCP certification at any time after the Contracting CSD is operating on T2S. The DCP certification of a CSD participant shall be valid for all Contracting CSDs from which it has authorisation to connect directly to T2S. DCP certification requires connectivity testing before the DCP starts its certification testing.

DCP certification is mandatory for any participant of the Contracting CSD that chooses to connect its IT systems directly to T2S. DCP certification shall require the participant of the Contracting CSD to execute a mandatory set of tests, agreed through the PMG substructure during the User Testing preparation phase. When the Contracting CSD allows its participants to connect directly to T2S and the Contracting CSD's participant chooses to connect directly to T2S, the Contracting CSD shall allow the Eurosystem to undertake the certification process directly with the Contracting CSD's participant.

A CSD participant has to certify itself once with the Eurosystem to connect directly to T2S. When the Contracting CSD allows its participants to connect directly to T2S, the Contracting CSD has the obligation to accept the DCP certification of its participant even when the Contracting CSD's participant has certified itself with the Eurosystem through another Participating CSD.

5.5 Business Day Testing Stage

The business day testing stage comprises the simulation of several consecutive business days of T2S operation after completing a Migration rehearsal using the expected production data set-up. It includes the Contracting CSD and its respective community as well as its Central Bank(s) and its Payment Bank(s). CSDs and their communities which have already migrated participate when deemed necessary, e.g. when links exist.

The objective of the business day testing stage is to verify the correct functioning of T2S under production-like conditions using the target data configuration as expected in the production environment. In this stage of testing, the expectation is that processing errors will stem mainly from incorrectly migrated data (e.g. incorrect positions or missing ISINs) or incorrect configuration (e.g. cross-CSD settlement parameters). This stage enables the T2S Actors, such as the CSDs and their communities, to identify such errors using real business data.

The business day testing stage includes operational procedures and service management to ensure that the operational procedures as described in the Manual of Operational Procedures (MOP) are

T2S Framework Agreement

Schedule 3 – User Testing

working as expected.

6 Non-functional tests

This section describes the non-functional tests carried out by the Eurosystem in order to confirm non-functional compliance of T2S as well as the non-functional volume tests carried out by the CSDs.

6.1 Description

The non-functional tests aim to check the proper functioning of T2S and are composed of the following tests as defined in the General Technical Design document:

- performance and stress tests;
- business continuity tests;
- security tests.

In principal, the Eurosystem will perform the non-functional tests, involvement of CSDs varies depending on the different types of non-functional tests. Prior to the execution, the Eurosystem will provide for a quick consultation these tests to the CSD. After the test execution, the Eurosystem will deliver a test report with results of those tests. Moreover, the CSDs will have the opportunity to execute non-functional tests from an end-to-end perspective and respecting the sizing of the related test environments. (see also section 5.5 Performance Tests by CSDs).

6.2 Objectives and responsibilities of performance and stress tests

The main objective of the performance and stress tests is to check that the T2S production environment is able to handle the estimated volume of transactions in a peak hour in terms of the number of settlements and a certain number of concurrent interactive users in compliance with a defined response time.

The test plan for the performance and stress tests includes a global system test aimed to measure throughput, response time and resource consumption of the whole system (infrastructure and applications) and volume tests conducted on specific parts of the system in order to optimise the behaviour of these T2S components.

During the performance and stress tests, different test cases shall be performed aiming to simulate the

T2S Framework Agreement

Schedule 3 – User Testing

expected daily workload profiles for User-to-Application mode (U2A) and Application-to-Application (A2A) interactions on the available interfaces by using simulators and/or with the collaboration of the Contracting CSD.

The test plan for the performance and stress tests shall follow a gradual approach to verify, in sequence, that all infrastructure components and services are sized properly to handle the defined peak workload of settlements and the T2S application is able to satisfy the defined performance requirements.

The performance and stress tests shall be performed by the Eurosystem. The T2S Actors shall be invited as observers to the performance and stress tests and the results of these tests shall be delivered to the Contracting CSD.

6.3 Objectives and responsibilities of Business Continuity tests

The main objective of the business continuity tests is to verify the ability of T2S to guarantee the continuity of business services in case of local component failure or regional disaster event. The business continuity tests shall demonstrate that T2S is sufficiently resilient to meet the agreed Service Levels, even in case of severe Incidents. The tests include intra-region and inter-region failover tests to guarantee that the production environment(s) can be switched to another site or region in a failover situation.

The business continuity tests shall be performed before the go-live and on a regular basis after the go-live.

The test plan for the business continuity tests shall include a comprehensive list of test cases including:

- fault tolerance (i.e. resiliency of single component);
- intra-region recovery;
- inter-region recovery (only regions 1 and 2).

In addition, tests shall be performed to validate the rotation between region 1 and region 2 that is closely linked to the disaster recovery test in terms of organisation and operational procedures.

The business continuity tests shall be performed by the Eurosystem. The T2S Actors shall be invited as observers to the business continuity tests and the results of these tests shall be delivered to the Contracting CSD.

T2S Framework Agreement

Schedule 3 – User Testing

6.4 Objectives and responsibilities of Security Tests

The main objectives of the security tests are to verify the compliance of the T2S Platform with the T2S security requirements. Security tests include:

- Vulnerability assessment;
- Configuration analysis;
- Penetration tests.

The Eurosystem shall perform these security tests and provide the results to the Contracting CSD.

6.5 Performance Tests by CSDs

Performance tests are typical non-functional tests that a CSD or DCP may want to perform. Depending on the intended volumes, such tests shall require central coordination and prior approval.

In case the Contracting CSD or its DCP(s) intends to exceed the pre-defined hourly volume limits, the Contracting CSD shall send a request for additional processing capacity for specific performance tests to the Eurosystem at least 5 working days in advance. The request should contain the volumes to be tested and the duration of the test. The Eurosystem will verify whether it can fulfil the request and shall inform the Contracting CSD or its DCP accordingly. If the Eurosystem cannot fulfil the request as specified, the Eurosystem shall propose alternative options in terms of dates, times and/or volumes. In case of conflicting requests, the Eurosystem shall consult the relevant Technical Groups.

7 User Testing in view of a Release deployment

In the event of the implementation of a new release (implementing correction to Production problems and/or Change Request) a testing should occur. The following principles shall apply for:

- The Technical Groups shall perform an impact assessment for a new T2S release or a new CB/CSD joining T2S on the T2S Actors in order to determine whether all T2S Actors will need to carry out User Testing for the T2S release or whether only affected T2S Actors need to test;
- Based on the impact assessment, the Project Managers Group (PMG) shall propose a test plan to the T2S Steering Level for approval;
- The test plan must ensure that CSDs, CBs and DCPs have sufficient time to verify that the delivered Changes meets the agreed requirements and specifications as defined in the T2S

T2S Framework Agreement

Schedule 3 – User Testing

Scope Defining Set of Documents.



EUROPEAN CENTRAL BANK

EUROSYSTEM

T2S FRAMEWORK AGREEMENT

SCHEDULE 4 MIGRATION

T2S Framework Agreement

Schedule 4 – Migration

1	INTRODUCTION	3
2	OBJECTIVE AND SCOPE	3
2.1	Objective	3
2.2	Scope	3
3	GENERAL RESPONSIBILITIES OF THE PARTIES	3
3.1	General responsibilities of the Eurosystem.....	3
3.2	General responsibilities of the Contracting CSD	5
3.3	Cooperation and escalation procedures	6
4	PREPARATION OF THE MIGRATION	6
4.1	Responsibilities of the Eurosystem.....	6
4.2	Responsibilities of the Contracting CSD	7
5	IMPLEMENTATION OF THE MIGRATION	9
5.1	Responsibilities of the Eurosystem.....	9
5.2	Responsibilities of the Contracting CSD	10
6	T2S MONITORING OF CLIENT READINESS FOR CONTRACTING CSD	11
6.1	Definitions, objectives and scope.....	11
6.2	Responsibilities	12
6.3	Client Readiness Reporting	12
6.4	Confidentiality and Transparency Rules	13
7	CLOSING PHASE	13
7.1	Responsibilities of the Eurosystem.....	13
7.2	Responsibilities of the Contracting CSD	13

Annex – List of Migration dates

T2S Framework Agreement

Schedule 4 – Migration

1 Introduction

This document presents how to prepare and conduct the Migration to T2S of the Contracting CSD and its community, as well as the roles and responsibilities of the Parties throughout the Migration process.

2 Objective and scope

2.1 Objective

The objective of this Schedule is to enable a smooth and successful transition to the usage of the T2S Services for the Contracting CSD and its community once the prerequisites for their Migration are fulfilled.

2.2 Scope

The scope of this Schedule covers all activities that are related to the testing, preparation of the T2S production environment for the successful Migration of a Contracting CSD and its community.

Whenever relevant, references will be made to coordination of activities with other T2S Actors, but the actual provisions applicable to those T2S Actors will be covered as part of the legal relationship with these T2S Actors.

3 General responsibilities of the Parties

The Eurosystem and the Contracting CSD shall cooperate in good faith for the preparation and execution of all T2S Migration activities.

3.1 General responsibilities of the Eurosystem

In view of preparing and ensuring a successful Migration to T2S of the Contracting CSD and its community, the Eurosystem shall:

- a) cooperate in good faith with the Contracting CSD and the other T2S Actors and provide them with all relevant information to prepare the necessary procedures and processes for all Migration activities and related deliverables;

T2S Framework Agreement

Schedule 4 – Migration

- b) coordinate, steer and monitor the T2S Migration process and, in agreement with the Signatory CSDs establish the Migration plan, the tasks and the milestones for the migration process;
- c) take all necessary actions required to facilitate, monitor and support the testing activities of the Contracting CSD in view of its Migration;
- d) prepare the Migration process which consists of three phases: (i) the planning phase, which consists of activities related to the preparation of the Migration activities that need to be planned in advance in order to mitigate the Migration risks; (ii) the implementation of the Migration, which consists of the actual preparations for live operations and (iii) the closing phase, which consists of closing reports;
- e) provide all reasonable support to non-euro area NCBs in T2S in ensuring the readiness of Dedicated Cash Accounts in their currency, prior to the first settlement of securities transactions in their currencies by a CSD located in the country of the non-euro area NCB in T2S. The opening of these Dedicated Cash Accounts will be driven by the request of the Dedicated Cash Account holders in accordance with the rules and conditions set up by the respective non-euro area NCB in T2S;
- f) upload and maintain the necessary Common Reference Data and system configuration parameters sufficiently in advance of the Migration of the Contracting CSD. The Common Reference Data will be created upfront with a future “valid from” date;
- g) provide support to the Contracting CSD for the transfer of:
 - i. the Common Reference Data as required, and;
 - ii. its CSD Reference Data and Dynamic Data prior to its Migration to T2S;
- h) report progress on the overall Migration process on a regular basis and share relevant information with the Contracting CSD and the Participating CSDs on the Contracting CSD’s level of readiness;
- i) apply an escalation and decision-making process in accordance with the general T2S governance arrangements, as specified in Schedule 8 (Governance);
- j) provide support to the Contracting CSD with regard to its Migration activities; and
- k) establish and attend a bilateral forum between the Eurosystem itself and each Signatory CSD to

T2S Framework Agreement

Schedule 4 – Migration

review and discuss the Contracting CSD individual status assessment for their activities.

3.2 General responsibilities of the Contracting CSD

In view of preparing and ensuring a successful Migration to T2S, the Contracting CSD shall:

- a) cooperate in good faith with the Eurosystem and with other relevant T2S Actors and provide all relevant information to prepare the necessary procedures and processes for all Migration activities and related deliverables;
- b) determine, in cooperation with the Participating CSDs, the date of its Migration to be listed in the Annex to this Schedule;
- c) migrate to T2S by the Migration Date;
- d) ensure its own testing completion and readiness for the Migration to T2S by the agreed Migration Date according to the procedures and processes agreed with the Eurosystem and other T2S Actors;
- e) take all necessary measures to facilitate the readiness of its community for the Migration to T2S by the agreed date according to the procedures and processes agreed with the Eurosystem and other T2S Actors;
- f) set up its own Migration project, define its testing and Migration plan, allocate appropriate resources to the implementation of such a plan, as well as assess and adjust such Migration plan and the allocated resources, where necessary, with a view to ensuring a smooth Migration to T2S according to the agreed plan; the adjustments to Migration plans must be discussed and agreed in the Governance of T2S as changes may have an impact on all the involved T2S Actors;
- g) upload and maintain the Common Reference Data as required);
- h) upload and maintain its CSD Reference Data and Dynamic Data prior to its Migration to T2S; these data will be created upfront with a future “valid from” date;
- i) maintain all the necessary links with the Participating CSDs until the end of its Migration in accordance with the provisions agreed between the Contracting CSD and Participating CSDs;
- j) provide training sessions to its community sufficiently in advance of community testing;

T2S Framework Agreement

Schedule 4 – Migration

- k) report progress on its readiness for Migration according to the agreed procedures, frequency and level of detail, with a particular view to identifying developments that might jeopardise the Migration of the Contracting CSD according to the agreed plan;
- l) nominate one person for coordinating all Migration activities within its own organisation and ensure that such person shall duly and regularly participate in the meetings organised by the Eurosystem until the Contracting CSD has migrated to T2S, and, in particular where this is not practicable, in the written procedures;
- m) mitigate the risk the Contracting CSD's community would impede the Migration of that CSD and the rest of its community, by limiting the dependencies between the Contracting CSD and its community as much as possible. In particular, keeping an indirect connection should be envisaged as contingency when the connectivity for a User wishing to connect directly does not work properly at the moment of the Migration; and
- n) participate in a bilateral forum between the Eurosystem and Contracting CSD to review and discuss its status assessment of its activities.

3.3 Cooperation and escalation procedures

The Eurosystem shall apply an escalation and decision-making process for communication in accordance with the general T2S governance arrangements, as specified in Schedule 8 (Governance).

4 Preparation of the Migration

This section presents the activities to be carried out for the testing and preparation of the Migration of a Contracting CSD and its community.

4.1 Responsibilities of the Eurosystem

In order to prepare and organise the Migration activities, the Eurosystem – in cooperation with the Contracting CSD – shall:

- a) set up a bilateral coordination structure between the Eurosystem and the Contracting CSD;
- b) agree with the Contracting CSD in establishing the tailored testing and Migration plan depending

T2S Framework Agreement

Schedule 4 – Migration

on its specificities;

- c) agree with the Contracting CSD the Migration plan which provides the Contracting CSD with the required information to execute the tasks and/or to carry out the actions required during the Migration;
- d) define the registration guide/procedures in order to enable the Contracting CSD to describe in detail their participation data, services used and account usage details;
- e) establish the structure and elements of the Migration profile for the Contracting CSD which gives a structured overview on their first day of operation in T2S;
- f) define the necessary Common Reference Data and CSD Reference Data and Dynamic Data to be uploaded in the system, as well as the relevant message formats;
- g) re-plan and reschedule certain Migration activities as required, based on a strong coordination and decision-making process between the Eurosystem and the Contracting CSD , in the eventuality that an unexpected event (within and out of the control of the CSD) will impede the Migration on the Migration Date;
- h) actively monitor throughout the Migration process the level of the Contracting CSD's preparedness;
- i) prepare progress reports to the appropriate Governance bodies on the status of the Contracting CSD based on the information provided by the Contracting CSD according to pre-agreed dashboard indicators; and
- j) establish the communication framework for the Migration process which covers the information exchanged with the Contracting CSD and the Participating CSDs and the market about the Migration process and about individual Migrations. Communications will be prepared jointly by the Eurosystem and the Signatory CSDs, in accordance with the relevant provisions of the Framework Agreement.

4.2 Responsibilities of the Contracting CSD

In order to prepare and organise the Migration related activities, the Contracting CSD – in cooperation with the Eurosystem – shall:

T2S Framework Agreement

Schedule 4 – Migration

- a) organise, prepare and monitor its own Migration process and take appropriate measures in order to ensure its own readiness for joining T2S;
- b) monitor and take all necessary measures to facilitate the readiness of its community for the Migration to T2S;
- c) cooperate with the Eurosystem in preparation of the standard testing and Migration plan;
- d) agree with the Eurosystem in establishing a tailored testing and Migration plan (including a fall-back plan) based on the standard Migration plan, and specify the type of support and tools, if any;
- e) coordinate the readiness of its community for Migration to T2S. The Contracting CSD shall take all necessary measures to facilitate the readiness of the Securities Accounts of its participants in T2S i.e. the creation and availability of Securities Accounts;
- f) monitor the readiness of Dedicated Cash Accounts on the basis of the confirmation provided by its participants (which the latter obtain from the relevant Central Bank(s)) regarding the creation and availability of Dedicated Cash Accounts in T2S;
- g) identify any “critical participants” that might jeopardize the Migration of the Contracting CSD and involve them actively in the Migration project, monitor their preparations more closely and possibly envisaging fall-back arrangements to settle their transactions;
- h) establish and maintain, if needed, interim procedures for handling the links with the non-migrated Participating CSDs, until all Participating CSDs have migrated to T2S;
- i) decide individually on the timing for the direct connectivity of members of its community (as of the first day of the Migration or after a stabilisation period) provided that the date has been communicated and agreed well in advance with the Eurosystem, and without prejudice to the Contracting CSD’s decision to offer direct connectivity or not;
- j) communicate the decision on the Migration Date of the direct connectivity well in advance to its Directly Connected Parties, in order to allow them to organise and plan their Migration activities; and
- k) ensure indirect connectivity for its Directly Connected Parties, in order to avoid any dependency between the Migration of the Contracting CSD and its Directly Connected Parties, in particular if

T2S Framework Agreement

Schedule 4 – Migration

some of its Directly Connected Parties are planned to migrate simultaneously.

5 Implementation of the Migration

The implementation of the Migration consists of the actual preparations and the execution of the tasks on the T2S production environment, in particular all activities that need to be carried out from the moment when the Eurosystem has made the T2S production environment available to the Contracting CSD until the successful Migration of the Contracting CSD.

5.1 Responsibilities of the Eurosystem

During the implementation of the Migration, the Eurosystem shall:

- a) carry out all the pre-Migration activities and the activities required during the Migration, according to the agreed plan;
- b) upload and maintain the necessary Common Reference Data and configuration data parameters sufficiently in advance of the Migration of the Contracting CSD; these data will be created upfront with a future “valid from” date;
- c) confirm the start of the activities during the Migration and subsequently the successful completion of each Migration on the basis of a report prepared in collaboration with the Signatory CSDs.;
- d) provide support to the Contracting CSD for the transfer of Common Reference Data its CSD Reference Data and Dynamic Data prior to the Migration of the Contracting CSD to T2S;
- e) report progress on the activities carried out during the implementation of the Migration by the Eurosystem and the Contracting CSD and the Participating CSDs according to the agreed procedures, frequency and level of detail, with a particular view to identifying aspects that might jeopardise the Migration according to the agreed plan;
- f) provide support to the Contracting CSD and the Participating CSDs to perform the required actions if needed; and
- g) provide all necessary support to the non-euro area NCBs in T2S that have committed to open Dedicated Cash Accounts in T2S, in order to allow the successful Migration of the relevant CSD(s) according to the T2S plan.

T2S Framework Agreement

Schedule 4 – Migration

5.2 Responsibilities of the Contracting CSD

Prior to its Migration Date, the Contracting CSD shall:

- a) obtain the certification from the Eurosystem for the uploading and the maintenance of Common Reference Data or CSD Reference Data on the T2S production environment as a pre-condition to start any activities on the T2S production environment;
- b) establish and verify its connectivity to the T2S production environment for each of the networks selected by the Contracting CSD; and
- c) upload and maintain the Common Reference Data as required.

Prior to the execution of its Migration, the Contracting CSD shall:

- a) obtain the certification from the Eurosystem for settling securities transactions on T2S;
- b) verify and confirm that its internal systems and processes and those of its participants are ready to efficiently interact with T2S;
- c) verify the availability of the necessary Dedicated Cash Accounts to be opened by the euro and non-euro area NCBs in T2S at the request of the Dedicated Cash Account holders;
- d) confirm to the Eurosystem its readiness for Migration and that of its community to T2S according to the agreed Migration plan;
- e) upload and maintain its CSD Reference Data as required prior to its Migration; these data will be created upfront with a future “valid from” date;
- f) complete all required forms for the registration on the T2S production environment and provide them to the Eurosystem by the agreed time;
- g) ensure timely access to relevant Common Reference Data and CSD Reference Data; and
- h) carry out all the required pre-migration activities according to the agreed Migration plan.

During the Migration , the Contracting CSD shall:

- a) carry out all the activities required according to the agreed Migration plan;

T2S Framework Agreement

Schedule 4 – Migration

- b) upload and maintain its Dynamic Data into the T2S production environment;
- c) report on the status of the activities carried out during the Migration according to the agreed procedures, frequency and level of detail; and
- d) confirm the end of its Migration based on the successful completion of the activities to be carried out during the Migration according to the agreed plan.

6 T2S Monitoring of Client Readiness for Contracting CSD

6.1 Definitions, objectives and scope

In the context of this Schedule,

- Client Readiness means the capability of Contracting CSD and its community - including DCP - to fulfil the legal, functional, technical and organisational requirements (i.e. all showstopper are resolved) to start operation in T2S as specified in the T2S Plan; and
- Monitoring of Client Readiness (MCR) means the framework to ascertain the readiness of a Contracting CSD and its community - including DCP - to start operation in T2S based on the Signatory CSDs' progress against the agreed milestones and deliverables of the T2S Plan.

The Parties to this Agreement agree to establish the MCR framework to allow the Eurosystem to monitor the readiness status of Contracting CSD to start operation with T2S. The objectives of the MCR Framework are:

- to ensure accurate reporting on the progress of Contracting CSD regarding its readiness level;
- to establish the necessary collaborative measures, rules, procedures and tools to support the monitoring process; and
- to foster the communication between the Contracting CSD and the Eurosystem on plan-related issues, with a view to ensure timely and proactive identification and notification of any event that would have a material effect on the Migration.

The scope of the MCR includes activities that the Contracting CSD and its community - including DCP - must undertake to ensure the required readiness level relative to the T2S Plan.

MCR covers all phases until the successful planned Migration. It also includes the monitoring of and

T2S Framework Agreement

Schedule 4 – Migration

reporting on the readiness of the Contracting CSDs clients, indirectly and directly connected to T2S. It should be noted that the Contracting CSD is responsible for tracking its own community - including DCP - and accurately reporting to the Eurosystem.

MCR encompasses the following activities:

- the monitoring of the fulfilment of the mutual obligations and deliverables;
- the monitoring and review of the mutual obligations in regular intervals and for individual periods, as bilaterally agreed, to ascertain their status; and
- the identification and notification of delays or any event affecting the successful and timely completion of the Migration.

6.2 Responsibilities

The Contracting CSD shall provide all relevant information regarding their progress towards a successful Migration to the Eurosystem. The Contracting CSD and the Eurosystem collaborate closely to support each other in the timely achievement of the relevant assessments, deliverables and milestones.

The Parties to this Agreement agree to meet bilaterally to review, assess and discuss the Contracting CSD's progress, based on agreed assessment criteria and status reporting methodology of this Schedule. Contracting CSD agrees to report for readiness monitoring:

- the progress against their adaptation plan and status of their deliverables; and
- their risks and issues pertaining to their adaptation and affecting the successful completion of the Migration.

The Eurosystem shall monitor actively the degree of client readiness and ask the Contracting CSD for regular monitoring of the status of the different activities and of the preparedness level of its communities -including DCP.

6.3 Client Readiness Reporting

The Eurosystem regularly reports on the migrating readiness as part of the status assessment and discusses the status with the Contracting CSD in bilateral meetings. The status of a specific Contracting CSD in the context of MCR is subject to the confidentiality and transparency rules (see Section 6.4). The Eurosystem intends to publish aggregated client readiness-relevant information on a regular basis

T2S Framework Agreement

Schedule 4 – Migration

to provide a summary of the T2S readiness status covering the entire community - including DCP. The Eurosystem reviews this assessment with the Contracting CSD prior to publication.

6.4 Confidentiality and Transparency Rules

The Eurosystem is committed to full transparency regarding T2S. T2S communication on client readiness addresses a wide spectrum of recipients, comprising individual Contracting CSD, various T2S governance bodies and the public.

Full transparency does not preclude confidentiality. As a matter of principle, Contracting CSD readiness status and internal issues, discussed in the MCR bilateral meetings, remain confidential unless they affect other Signatory CSDs, and/or the T2S business case. Communication of any other topics to a Third Party shall require prior written mutual consent.

7 Closing phase

The closing phase covers the final reporting and the assessment of the lessons learned during the Migration process.

7.1 Responsibilities of the Eurosystem

During the closing phase, the Eurosystem shall provide reports on lessons learned from the Migration to be applied to the next Migration to the PMG;

7.2 Responsibilities of the Contracting CSD

During the closing phase, the Contracting CSD shall provide feedback to the Eurosystem based on its experience gained during its Migration in order to improve future Migrations.



EUROPEAN CENTRAL BANK

EUROSYSTEM

T2S FRAMEWORK AGREEMENT

SCHEDULE 04 - ANNEX LIST OF MIGRATION DATES

T2S Framework Agreement

Schedule 04 – Annex – List of Migration Dates

This is a list of past (completed) and planned Migrations dates to T2S.

Enty short name	Country	Migration date (1st date in operation)	Comment on Migration date
AB Lietuvos	Lithuania	18-Sep-17	
AS Esti	Estonia	18-Sep-17	
AS Latvijas	Latvia	18-Sep-17	
BNBGSSS	Bulgaria	Planned 11-Sep-2023	
CDAD	Bulgaria	Planned 11-Sep-2023	
CDCP	Slovakia	06-Feb-17	
Clearstream	Germany	06-Feb-17	
Depozitarul	Rumania	22-Jun-15	
Euroclear Bank	Belgium	Planned 11-Sep-2023	
Euroclear BE	Belgium	12-Sep-16	
Euroclear Fi	Finland	Planned 11-Sep-2023	Initially planned with Wave 4 (18/09/2017)
Euroclear FR	France	12-Sep-16	
Euroclear NE	Nederland	12-Sep-16	
Iberclear	Spain	18-Sep-17	
Interbolsa Portugal	Portugal	28-Mar-16	
KDD	Slovenia	06-Feb-17	
KELER	Hungary	06-Feb-17	
LuxCSD SA	Luxemburg	06-Feb-17	
Malta stock	Malta	22-Jun-15	
Monte Titoli	Italy	31-Aug-15	
NB Greece SSS	Greece	22-Jun-15	
NB of BE SSS	Belgium	28-Mar-16	
OeKB	Austria	06-Feb-17	
SIX SIS	Switzerland	22-Jun-15	
SKDD	Croatia	Planned 11-Sep-2023	
VP securities	Denmark	12-Sep-16	
ID2S	France	28-Oct-18	Left T2S 15/02/2022
Mellon	Belgium	N/A did not migrate	Left T2S
Narodny	Slovakia	30-Oct-17	Left T2S 12/11/2021
VP LUX	Luxemburg	12-Sep-16	Left T2S 09/11/2018
NCDCP	Slovakia	27-Oct-17	Holdings transferred to CDCP on 15/11/2021



EUROPEAN CENTRAL BANK

EUROSYSTEM

T2S FRAMEWORK AGREEMENT

SCHEDULE 5

T2S SERVICE DESCRIPTION

T2S Framework Agreement

Schedule 5 – T2S Service Description

Table of contents

1	T2S Service Description overview	6
1.1	Objective of the T2S Service Description	6
1.2	Scope of the T2S Service Description	6
1.3	T2S Service Description and its relationship to other documents	7
2	Service delivery framework	8
2.1	Scope of T2S instrument	8
2.2	Scope of T2S instruction and transaction type	8
3	T2S SD: Overview T2S Services	9
4	T2S SD.SETT: Settlement services service class	11
4.1	T2S SD.SETT 010: Business validation service	11
4.2	T2S SD.SETT 020: Matching service	13
4.3	T2S SD.SETT 030: Allegement service	15
4.3.1	T2S DD.SETT 031: Settlement allegement service component	15
4.3.2	T2S SD.SETT 032: Cancellation allegement service component	15
4.4	T2S SD.SETT 040: Settlement sequencing service	16
4.5	T2S SD.SETT 050: Settlement posting service	16
4.5.1	T2S SD.SETT 051: Settlement eligibility check service component	17
4.5.2	T2S SD.SETT 052: Provisioning service component	17
4.5.3	T2S SD.SETT 053: Booking service component	19
4.6	T2S SD.SETT 060: Optimisation service	19
4.6.1	T2S SD.SETT 061: Technical netting and optimisation algorithms service component	20
4.6.2	T2S SD.SETT 062: Prioritisation service component	20
4.6.3	T2S SD.SETT 063: Partial settlement service component	21
4.6.4	T2S SD.SETT 064: Auto-collateralisation service component	22
4.7	T2S SD.SETT 070: Realignment service	27
4.8	T2S SD.SETT 080: Instruction recycling service	27
4.9	T2S SD.SETT 090: Instruction amendment service	28

T2S Framework Agreement

Schedule 5 – T2S Service Description

4.10	T2S SD.SETT 100: Instruction cancellation service	29
4.11	T2S SD.SETT 110: Hold/release service	30
4.12	T2S SD.SETT 120: Earmarking, blocking and reservation service	31
4.12.1	T2S SD.SETT 121: Earmarking service component	31
4.12.2	T2S SD.SETT 122: Blocking service component	31
4.12.3	T2S SD.SETT 123: Reservation service component	31
4.12.4	T2S SD.SETT 123: Common features of the earmarking, blocking and reservation service component	32
4.13	T2S SD.SETT 140: Conditional Security Delivery (CoSD) service	33
4.14	T2S SD.SETT 150: Linked instructions service	34
4.15	T2S SD.SETT 160: Corporate actions service	35
4.16	T2S.SD.SETT 170: Penalty Mechanism service	36
4.16.1	T2S.SD.SETT 171: Cash penalties identification service component	36
4.16.2	T2S.SD.SETT 172: Cash penalties computation service component	38
4.16.3	T2S.SD.SETT 173: Cash penalties adjustment service component	40
5	T2S SD.LIM: Liquidity Management Service Class	41
5.1	T2S SD.LIM 010: Liquidity transfer service	41
5.2	T2S SD.LIM 020: Limit management service	44
5.3	T2S SD.LIM 030: End of day (EOD) cash management service	45
5.4	T2S SD.LIM 040: Corporate action cash service	46
5.5	T2S SD.LIM 050: Cash blocking and reservation service	47
5.6	T2S SD.LIM 060: Liquidity monitoring service	48
5.7	T2S SD.LIM 070: Multiple liquidity provider service	49
6	T2S SD-STD: Common Reference Data Management Service Class	50
6.1	T2S SD.STD 010: Common Reference Data management service	50
6.1.1	T2S SD.STD 011: Insert service component	51
6.1.2	T2S SD.STD 012: Update service component	51
6.1.3	T2S SD.STD 013: Delete service component	52
6.1.4	T2S SD.STD 014: Reactivate service component	52
6.2	T2S SD.STD 020: Securities Reference Data service	52

T2S Framework Agreement

Schedule 5 – T2S Service Description

6.3	T2S SD.STD 030: T2S Party data service	53
6.4	T2S SD.STD 040: Security Account data service	55
6.5	T2S SD.STD 050: Cash account data service	56
6.6	T2S SD.STD 060: T2S User data service	57
6.7	T2S SD.STD 070: Roles and privileges data service	58
6.8	T2S SD.STD 080: Restriction management service	59
6.9	T2S SD.STD 090: Attribute domain data service (market-specific attributes)	61
7	T2S SD. INF: Information Management Service Class	62
7.1	T2S SD.INF 010: Status management services	62
7.2	T2S SD.INF 020: Report generation service	62
7.3	T2S SD.INF 030: Query service	65
7.3.1	T2S SD.INF 031: Query service for T2S Actor service component	65
7.3.2	T2S SD.INF 032: Query service for CSDs service component	66
7.3.3	T2S SD.INF 033: Query service for Central Banks service component	66
7.3.4	T2S SD.INF 034: Query service for Payment Banks (liquidity providers) service component	66
7.3.5	T2S SD.INF 035: Settlement-related queries service component	66
7.3.6	T2S SD.INF 036: Cash balance-related queries service component	67
7.3.7	T2S SD.INF 037: Common Reference Data-related queries service component	68
8	T2S SD. CON: Connectivity / Communication Service Class	70
8.1	T2S SD.CON 010: Messaging services	71
8.1.1	T2S SD.CON 011: Push messaging service component	71
8.1.2	T2S SD.CON 012: Pull messaging service component	73
8.2	T2S SD.CON 020: Technical validation services	73
8.3	T2S SD.CON 030: Connectivity types services	74
8.3.1	T2S SD.CON 031: Application to Application (A2A) service component	74
8.3.2	T2S SD.CON 032: User to Application (U2A) service component	74
8.4	T2S SD.CON 040: Information Security management services	74
8.4.1	T2S SD.CON 041: Authentication service component	74

T2S Framework Agreement

Schedule 5 – T2S Service Description

8.4.2	T2S SD.CON 042: Authorisation service component	75
8.4.3	T2S SD.CON 043: 4-eyes principle service component	75
8.5	T2S SD.CON 050: Message sequencing services	76
8.6	T2S SD.CON 060: Direct Connectivity Services	76
8.7	T2S SD.CON 070: Routing services	77
9	T2S SD. SUP: Operations and support service class	78
9.1	T2S SD.SUP 010: T2S Business Application configuration services	78
9.1.1	T2S SD.SUP 011: T2S Calendar service component	78
9.1.2	T2S SD.SUP 012: T2S Settlement Day service component	79
9.2	T2S SD.SUP 020: Operational monitoring services	80
9.3	T2S SD.SUP 030: Business continuity management services	81
9.4	T2S SD.SUP 040: Disaster recovery and crisis management services	81
9.5	T2S SD.SUP 050: Archiving services	82
9.6	T2S SD.SUP 060: T2S service desk services	82
9.7	T2S SD.SUP 070: Service Level management services	83
9.8	T2S SD.SUP 080: Invoicing services	83
9.8.1	T2S SD.SUP 081: T2S invoicing to CSDs and Central Banks service component	84
9.8.2	T2S SD.SUP 082: CSDs / Central Banks invoicing support service component	85
9.9	T2S SD.SUP 090: Change and Release Management services	85
9.9.1	T2S SD.SUP 091: Change Management service component	86
9.9.2	T2S SD.SUP 092: Release Management service component	87
9.10	T2S SD.SUP 100: Test and training services	88
9.10.1	T2S SD.SUP 101: Testing service component	88
9.10.2	T2S SD.SUP 102: Training service component	89

1 T2S Service Description overview

1.1 Objective of the T2S Service Description

This Schedule provides a common base for the description of T2S Services, especially pertaining to the T2S Framework Agreement and to the T2S Currency Participation Agreement.

This Service Description for the T2S Services focuses on:

- (1) providing a common structure for the services that T2S will deliver, i.e. settlement services, liquidity management, Common Reference Data services, information services, Connectivity Services, operational and support services as well as the individual services;
- (2) the content of the service from the T2S Users' perspective, i.e. what services the T2S Users will receive, and the business perspective of the interchanges between T2S and the T2S Users; and
- (3) the boundaries of the services T2S will deliver to its users, i.e. what is within the scope of T2S Services, and what is outside of the scope of T2S Services.

Some of the T2S Services listed in this Schedule are delivered by means of Common Components.

1.2 Scope of the T2S Service Description

T2S is a technical solution to support Central Securities Depositories (CSDs) by providing core, borderless and neutral settlement services. The objective is to achieve harmonised and commoditised settlement in Central Bank Money (CeBM) in euro and other eligible currencies for substantially all securities in Europe.

The Eurosystem manages and operates the T2S Business Application and the technical solution providing the T2S Services. This service provision by the Eurosystem is hereafter referred to simply as "T2S". The Contracting CSD will maintain full control over the business and contractual relationship with its customers.

The T2S Service Description describes all services T2S will deliver for the T2S Services including all services delivered to all Signatory CSDs, to all Directly Connected Parties (DCPs), and to all Central Banks. The T2S Service Description itself is subject to the rules and procedures established for all Schedules and Annexes of the T2S Framework Agreement.

T2S Framework Agreement

Schedule 5 – T2S Service Description

The Service Description furthermore provides background and relevant information with regard to the Service Level Agreement (SLA¹), which contains all Key Performance Indicators (KPIs), the latter will not be defined nor referenced in the Service Description. The T2S technical architecture is not described in this Service Description and nor are the technical details required to establish the connectivity to T2S.

This Service Description describes only the services T2S shall deliver.

The need to update the service description shall be assessed on a yearly basis. Amendments to this Schedule that have been previously approved as a direct follow-up of a Change Request shall be implemented through the procedure indicated in Article 47(2) of this Agreement.

1.3 T2S Service Description and its relationship to other documents

The Service Description is a high-level description of the T2S Services and as such complementing the T2S Scope Defining Set of Documents.

Since, the Service Description is a high-level description of the T2S Services, in some parts of the Service Description it has been indicated in which documents, e.g. Business Process Description, User Handbook, Manual of Procedures (MoP), further and more detailed information can be found.

¹ The SLA is a separate document linked closely to this Service Description. The Service Description describes the services T2S clients receive, the SLA defines the relevant KPIs, as well as their control and reporting procedures. Therefore, these two documentations are closely linked and harmonised

2 Service delivery framework

2.1 Scope of T2S instrument

In principle, T2S covers all securities that comply with the following eligibility criteria, i.e. that:

1. have an ISIN code, as instrument identifier;
2. can be settled via a CSD in T2S;
3. can be settled in book-entry form; and
4. are fungible (from a settlement process perspective).

Securities that do not fall within the scope of any Signatory CSD are not part of T2S either.

T2S can settle only securities that are compliant with the above criteria 1 to 3. Certain securities, compliant with the first three criteria, but not compliant with criteria 4 (non-fungible from a settlement perspective), may still be entered in and processed by T2S.

T2S settles all eligible securities in a standardised settlement process.

2.2 Scope of T2S instruction and transaction type

The instruction types covered by T2S are the following:

- Settlement Instruction
- Liquidity Transfer
- Settlement Restriction
- Amendment Instruction
- Cancellation Instruction
- Hold / Release Instruction

T2S settles only settlement transactions with a CeBM cash leg (or no cash leg), it will not provide settlement in Commercial Bank Money (CoBM). T2S provides services for securities settlement and the related cash settlement using a number of transaction types:

- FOP (Free-of-Payment) consists of DFP (Deliver-Free-of-Payment) and RFP (Receive-Free-of Payment). In both cases, securities are delivered / received without payment being made.
- DVP (Delivery-versus-Payment) and RVP (Receive-versus-Payment) define an exchange of securities for cash. DvP and RvP are both securities settlement

T2S Framework Agreement

Schedule 5 – T2S Service Description

mechanisms which link a securities transfer and a funds transfer in such a way as to ensure that delivery occurs if - and only if - the corresponding payment occurs.

- DWP (Deliver-with-Payment) and RWP (Receive-with-Payment) is a type of instruction and settlement mechanism, specifying the delivery of securities together with a cash payment. For example, trade netting by a Central Counterparty (CCP), as an authorised CSD participant, may result in such instructions.
- PFOD (Payment-Free-of-Delivery) defines an exchange of cash without the delivery of securities.

3 T2S SD: Overview T2S Services

T2S deploys a flexible hierarchical party model to allow Signatory CSDs and Central Banks to manage their accounts and parties in an efficient way. Roles, including some of the key responsibilities, are allocated in line with the differentiation into:

- a securities' perspective (Signatory CSDs); and
- a cash's perspective (Central Banks).

The structure of this Service Description document is based on the above -mentioned differentiation between the securities perspective (Signatory CSDs) and the liquidity management perspective (Central Banks)²:

- CSDs are the gateways through which various market parties can access T2S. Depending on their needs, CSD's participants may continue to contract with one or more CSDs for the settlement of their trades and collateral operations (and those of their customers) in T2S. Each CSD will set up and maintain its own Security Accounts' structure in T2S. Each CSD is responsible for setting up and maintaining all CSD Reference Data relating to the settlement activities of its participants. A T2S Actor settling through more than one CSD in T2S can have Security Account(s) with each of the CSDs it uses for settlement.
- All Central Banks have the responsibility to set up and to maintain Dedicated Cash Accounts (DCAs) in T2S if they have concluded a relevant agreement with eligible

² A more detailed description of the account structures deployed by T2S can be found in the User Detailed Functional Specifications (UDFS), chapter 1.2.6. Accounts structure and organisation

T2S Framework Agreement

Schedule 5 – T2S Service Description

entities. Furthermore, they are also responsible for setting up and maintaining all Central Bank reference data relating to the DCAs of its members. Cash settlements in T2S take place exclusively on T2S DCAs. Only a CeBM account opened on the books of a Central Bank may serve as a T2S DCA.

The totality of the T2S Services (level 1 of the service hierarchy description) are broken down into service classes (level 2 of the service hierarchy) and services (level 3). If the latter (level 3) contain functionally diverse components, level 4 of the service hierarchy describes these service components:

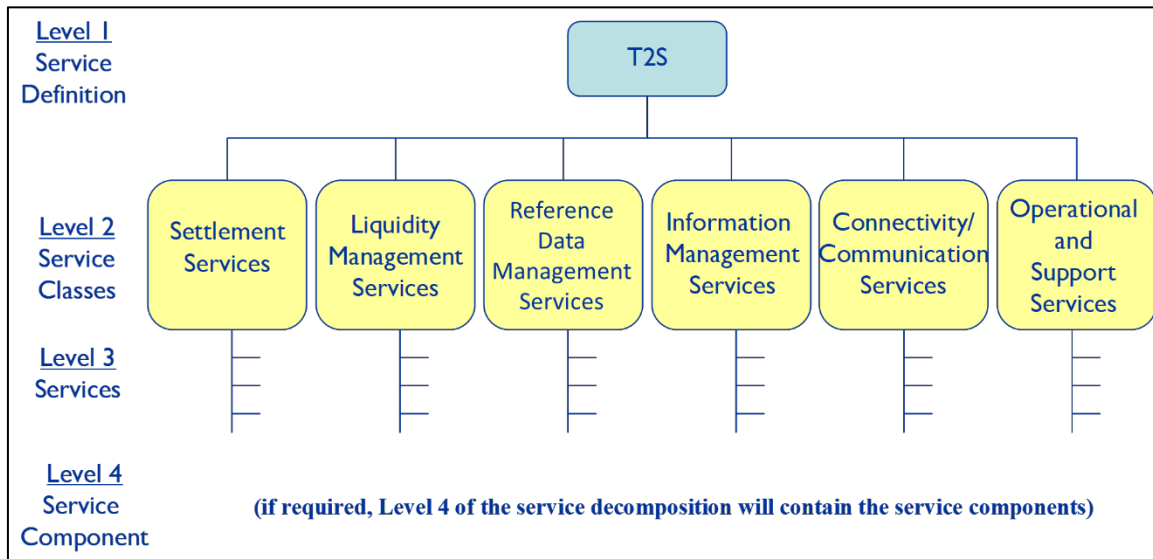

4 T2S SD.SETT: Settlement services service class

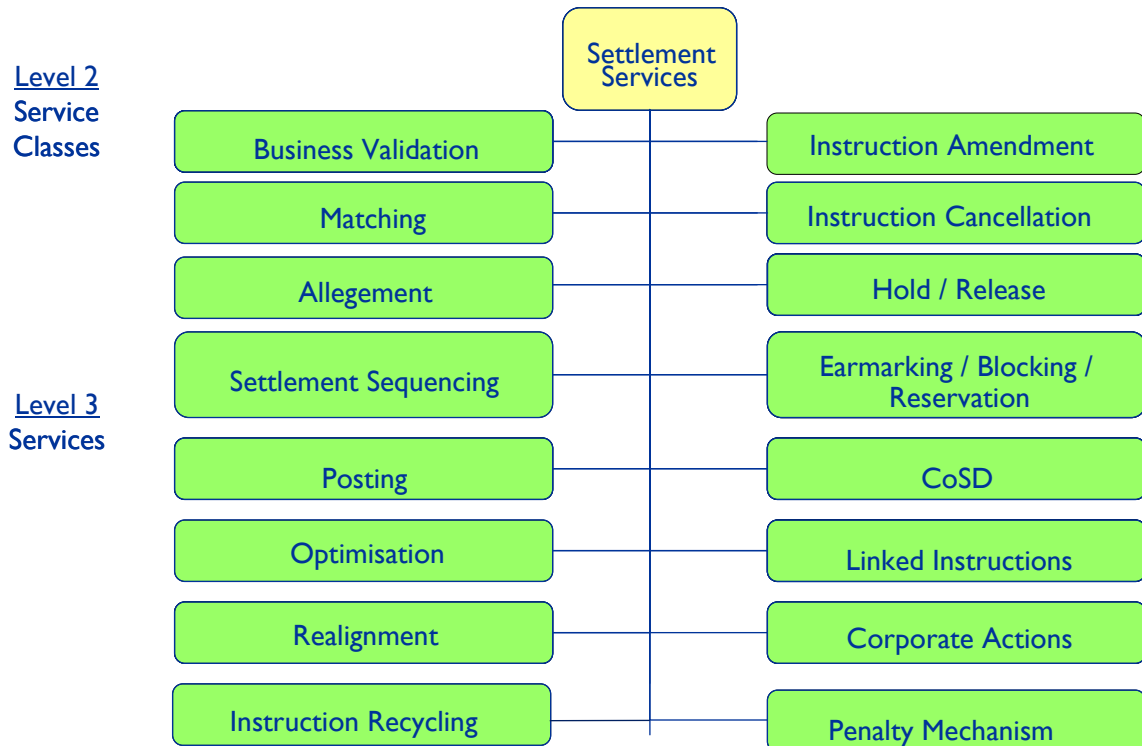

4.1 T2S SD.SETT 010: Business validation service

Each instruction will go through the same T2S standard validations.

With the exception of the additional information fields as described below, the business validation service ensures that the content of the received message is valid, i.e. contains all required fields and complies with the rules defined for the content of these fields. These consistency checks ensure that the message can be processed by T2S as intended and is consistent with the relevant rules for this message stored in Common Reference Data.

Business validation in T2S consists of two different types of validations:

1. Contextual checks, that is when the validation of one field is dependent on the content of another field, e.g. reference / Common Reference Data or other data provided via the Graphical User Interface (GUI); and
2. Event-driven checks, e.g. settlement date change.

T2S Framework Agreement

Schedule 5 – T2S Service Description

All incoming messages are validated when they enter T2S and re-validated (as are all pending instructions) at the start of a new Settlement Day. Updates of the Common Reference Data used for business validation purposes result in revalidation of all relevant instructions. T2S assigns a status of matched/unmatched at the same time that the instruction is validated.

Messages sent by a T2S Actor to T2S may contain Additional Information Fields which T2S Actors may use for their own purposes. This additional information is neither required for nor related to any T2S process and is therefore neither validated nor further processed within T2S. T2S stores this additional information together with the information it has processed.

Once T2S has successfully validated the compliance of the data - contained in the instruction with the data stored in Common Reference Data relevant for the business validation process - the instruction is routed to the relevant processing module of T2S. If settlement-related process indicators are specified by the instructing T2S Actor, T2S checks that they are valid for the type of instruction and the instructing T2S Actor in question. The settlement-related process indicators are used to perform certain actions in the settlement process relating to an instruction. T2S Actors may use the non-settlement-related link indicator "INFO" to link instructions for information purposes.

In the event of instructions being held/released, cancelled, amended or that make use of a previous settlement restriction, T2S verifies that the previous or related reference exists. T2S performs the business validation on the maintenance/new instruction to ascertain that it is valid and consistent with the previous or related instruction. After identifying a validation error, T2S continues to validate as far as possible (taking into account potential interdependencies between the validated data). If validation errors are found, T2S reports all of them in a single message to the T2S Actor and rejects the instruction.

After successful validation, T2S stores the instruction, assigns the corresponding statuses and informs the instructing T2S Actor and its CSD of the validation result, depending on their message subscription preferences. Once validated:

- settlement instructions that require Matching are forwarded for Matching;
- maintenance instructions are forwarded to the maintenance functionality; and
- settlement restrictions are forwarded for settlement only on their Intended Settlement Date (ISD),

while all other instructions are forwarded directly to the settlement functionality.

T2S Framework Agreement

Schedule 5 – T2S Service Description

T2S must support the Signatory CSDs and Central Banks by offering the capability to provide specific validations and processing of messages to fulfil Legal and Regulatory Requirements as well as supervisory requirements in the markets that they service. T2S therefore allows the Signatory CSDs and the Central Banks to define their own restriction types.

T2S triggers a revalidation of all relevant recycled instructions when settlement-related Common Reference Data change. T2S cancels instructions that do not pass the revalidation successfully and informs both the CSD and the instructing T2S Actor of the cancellation.

T2S validates all incoming and recycled instructions against rules and parameters defined in the Common Reference Data for the configuration of restriction types. T2S thus checks and validates whether there are any applicable restrictions. If there are, and depending on the type of the restriction, T2S either accepts, rejects or puts the instruction on hold until it is released for further processing.

4.2 T2S SD.SETT 020: Matching service

The settlement instruction Matching service in T2S compares the settlement details provided by the buyer of securities with those provided by the seller of the securities in order to ensure that both parties agree on the settlement-related terms of an instruction.

T2S provides real-time Matching, compliant with the rules of the European Securities Services Forum (ESSF)/European Central Depositories Association (ECSDA), throughout the operating day (except during the Maintenance Window). Matching in T2S is mandatory for cross-CSD settlements. Matching for intra-CSD settlements may take place in T2S or in the legacy systems of the CSD.

T2S only attempts to match validated settlement instructions that entered T2S as “unmatched”. If Matching is successful, T2S assigns the match status “matched” to the settlement instructions and informs the T2S Actor of the Matching of their settlement instruction. If T2S finds no corresponding unmatched counterpart instruction for the unmatched settlement instruction, the match status remains unchanged and T2S sends no information to the instructing T2S Actor.

T2S waits for the missing counterpart instruction for a predetermined period before generating an allegation message for the counterpart in the unmatched instruction. T2S sends the allegation message to the relevant counterparty only if the counterparty has subscribed to receive allegation messages.

T2S Framework Agreement

Schedule 5 – T2S Service Description

T2S attempts to match the instruction for 20 business days (T2S calendar) after the Intended Settlement Date or the date of the last status change, in accordance with the ESSF/ECSDA recommendation. After 20 business days, T2S cancels the underlying instruction and informs the relevant T2S Parties.

T2S matches the settlement cash amount for T2S eligible settlement currencies with a certain tolerance level (i.e. in the event that there is no perfect match). The tolerance amount has two different bands per currency, depending on the counter value, in line with ECSDA rules. The general tolerance amount proposed by ECSDA for Matching the settlement amount field in euro is currently €25 when the counter value is above €100,000 or €2 when it is €100,000 or less. Once T2S has matched two instructions with a difference in the settlement amount that is less than the tolerance amount, T2S shall settle the instruction with the seller's settlement amount.

T2S matches different types of fields:

1. Mandatory matching fields

Mandatory Matching fields are those fields that must exist in the instruction and which values should be the same in both Settlement Instructions except for (i) the Settlement Amount of DVP/PFOD instructions for which a tolerance might be applied; and (ii) the Credit/Debit Code (CRDT/DBIT); and (iii) the Securities Movement Type Deliver/Receiver (DELI/RECE), whose values match opposite (meaning that opposite values in instructions are considered as required to match the instructions).

2. Non-mandatory Matching fields

T2S supports two types of non-mandatory Matching fields:

- a. Additional Matching fields are fields that are initially not mandatory but become mandatory Matching fields when either one of the counterparts to the settlement provides a value for them in its instruction. T2S cannot match a filled-in additional Matching field with a field with no value (null / zero value).
- b. Optional Matching fields are fields that are initially not mandatory:
 - i. If only one T2S Actor provides content in an optional Matching field, T2S may match with a field with no value (null / zero value).
 - ii. If both settlement counterparts provide a value for the same field in their instructions, then the optional Matching field becomes mandatory for Matching.

T2S Framework Agreement

Schedule 5 – T2S Service Description

4.3 T2S SD.SETT 030: Allegement service

T2S uses allegement messages to inform counterparties that an instruction is missing. An allegement message advises an account owner that another T2S Actor has issued instructions against its account for which the account owner has no corresponding instruction in the Securities Settlement System. Allegements will be sent only if the counterparty has subscribed to receive such messages. T2S alleges a T2S Actor when a settlement instruction or a cancellation instruction is missing. Allegement messages may be used for any unmatched instruction that requires Matching.

4.3.1 T2S DD.SETT 031: Settlement allegement service component

After the first unsuccessful Matching attempt, T2S waits for the missing counterparty instruction for a predetermined period of time before generating an allegement message. If the instruction is still unmatched at the end of this period, an allegement message is generated. T2S sends an allegement message for the unmatched instruction only if the counterparty has subscribed to receive allegement messages.

T2S supports two standard delay periods for sending allegements to the counterparties of the unmatched instruction:

- “Allegement from first unsuccessful Matching attempt”, as the standard delay period from the first unsuccessful attempt to match a settlement instruction.
- “Allegement before Intended Settlement Date”, as the standard delay period measured backwards from the FOP cut-off time on the Intended Settlement Date.

T2S sends out the allegement at the earliest point in time between the two standard delay periods. T2S calculates the standard delay period in hours and minutes.

If the previous allegement message is no longer valid, T2S sends an allegement removal or an allegement cancellation. An allegement cancellation means the cancellation of an allegement message sent previously, due to a cancellation of the settlement instruction by the sender. An allegement removal acknowledges that an allegement message sent previously is no longer valid, because T2S has in the meantime received the missing instruction from the alleged T2S Party.

4.3.2 T2S SD.SETT 032: Cancellation allegement service component

T2S also provides allegement services in the event of a missing counterpart cancellation instruction, via a status advice message. T2S sends out the cancellation allegement without waiting for any predetermined period to have elapsed. The cancellation instruction remains pending until it matches with a valid counterpart cancellation instruction.

If the cancellation allegement sent via status advice is no longer valid because the

T2S Framework Agreement

Schedule 5 – T2S Service Description

revalidation of the settlement instruction has been unsuccessful, the counterparty has responded with a cancellation instruction, or the underlying matched settlement instructions have been settled, T2S sends only the settlement confirmation (in case of settled underlying instructions) and status advices (in case of cancelled underlying instructions) to both parties.

T2S does not send a status advice to the counterparty to communicate cancellation of the previous cancellation allegation.

4.4 T2S SD.SETT 040: Settlement sequencing service

Sequencing is the pre-determined order defined in T2S in which instructions are submitted for settlement.

During the Real-time Settlement, instructions are processed in the order in which they arrive for settlement.

For night-time settlement, sequencing refers to the order in which the settlement of certain sets of instructions is attempted in T2S. Settlement instructions are processed in a particular sequence, (i.e. in a fixed order) to avoid the use of security positions and/or cash resources for any transaction other than those submitted in the sequence concerned. T2S runs two settlement cycles with predefined settlement sequences during the night. In each settlement sequence, T2S will perform a settlement attempt for those settlement transactions selected based on the eligibility criteria of the sequence including:

- all new instructions with the current ISD entered into T2S until the launch of the current settlement sequence. These instructions include, for instance, settlement instructions providing liquidity via lending (securities lending) that are intended to settling instructions that could not be settled in an earlier settlement attempt; and
- all recycled instructions that could not be settled in an earlier settlement attempt. Such recycled instructions include all instructions that could not be settled in the previous settlement attempts.

4.5 T2S SD.SETT 050: Settlement posting service

The transactions are settled in T2S by booking the cash and securities debits and credits in accordance with the relevant instructions on the relevant T2S DCAs and Security Accounts (either accounts identified in the instructions being settled or accounts

T2S Framework Agreement

Schedule 5 – T2S Service Description

predetermined by default).

The settlement posting service consists of three service components:

- Settlement eligibility check
- Provisioning
- Booking

4.5.1 T2S SD.SETT 051: Settlement eligibility check service component

The settlement eligibility check is the final validation before settlement, as it is necessary to identify the appropriate instructions for the final settlement process. The eligibility check considers:

- the Intended Settlement Date (ISD);
- the potential blocking of the T2S Actor, Security Account, security or T2S DCA from settlement;
- whether or not the instruction is on hold; and
- whether the instruction is linked to other instructions,

before an instruction is submitted to the provisioning and booking process. T2S forwards for settlement only those instructions that meet the eligibility criteria for settlement. Settlement instructions which do not meet the eligibility criteria remain unsettled.

4.5.2 T2S SD.SETT 052: Provisioning service component

The provisioning or provision-check ensures that the eligible transaction can be forwarded for booking (and thereby finally settled) if, and only if, the booking does not cause the account balances of the relevant securities and the T2S DCA to become negative, with the exception of T2S Central Bank's own accounts, T2S transit accounts and Issuer CSD balance accounts, which may have negative balances.

The provision-check covers both settlement legs of the relevant transaction (e.g. the cash and securities legs for a DvP transaction). T2S does not consider reserved/blocked securities quantities or cash amounts on the relevant accounts as available for the provision-check, unless the instruction being settled refers to the initial reservation/blocking instruction.

When an individual external guarantee limit, unsecured credit limit or auto-collateralisation limit is defined by the relevant Central Banks (or by the relevant Payment Bank for the settlement of the instructions of the T2S parties for which it provides cash settlement services), T2S ensures that the net cash debit resulting from the booking of any

T2S Framework Agreement

Schedule 5 – T2S Service Description

instruction(s) of the relevant T2S parties does not exceed the unused part of this external guarantee limit, unsecured credit limit or auto-collateralisation limit.

T2S performs the provision check in the following sequence:

1. Provision check of available securities position on the Security Account (only for the settlement of securities).
2. Provision check for the T2S DCA and auto-collateralisation (if required).
3. Provision check on the external guarantee limit.
4. If auto-collateralised: provision check on the auto-collateralisation limit of the client of the Payment Bank.
5. Provision check on the unsecured credit limit.

When several instructions are submitted together in a settlement attempt, the provision-check considers the final net balance resulting from the booking of all the relevant instructions (and not from each and every instruction). In other words, in its provision-check T2S takes into account the technical netting effect.

If the provision-check on the net balance is not satisfactory, T2S identifies the instruction(s) responsible for the provision-check's failure.

These instructions are either:

- submitted for an auto-collateralisation process if the fail originates from a lack of cash; or,
- submitted for partial settlement (only as a last resort, i.e. if auto-collateralisation is not possible or not sufficient and only if the instructions are eligible and are within the partial settlement window) if the fail originates from a lack of securities or from a required substitution of collateral.

T2S Framework Agreement

Schedule 5 – T2S Service Description

4.5.3 T2S SD.SETT 053: Booking service component

Final booking is only posted if the provision-check on the accounts (securities and T2S DCAs) referred to in the settlement instructions (or on the accounts predetermined by default) is satisfactory.

Once booked by T2S on the T2S parties' Security Accounts and T2S DCAs, cash and securities debits and credits are final, i.e. irrevocable and unconditional. The booking must not be conditional on any external event (e.g. such as another booking in the payment or settlement system/arrangement of an external Central Banks registrar, commercial bank or CSD), this means that any such condition must have been resolved before the booking in T2S is undertaken.

Because bookings are final, T2S will not automatically unwind credit or debit even if it was done incorrectly.

Each and every transaction is booked on a gross basis. This is without prejudice to the use of the technical netting effects in the provision check when several instructions are submitted together for settlement (either for optimisation purposes or because they are linked by a T2S Actor).

4.6 T2S SD.SETT 060: Optimisation service

T2S optimisation services is intended to determine the optimum balance between maximising the volume and the value of the settlement with the available securities, in order to minimise the number and value of unsettled instructions at the end of the night-time settlement process as well as to minimise the number and value of fails at the end of the Settlement Day.

Optimisation procedures are specific processes aimed at increasing settlement efficiency. Such processes detect and resolve settlement gridlocks, and perform technical netting of obligations in cash and securities, with a view to settle new instructions as well as instructions that could not be settled when previously attempted. Optimisation procedures are available both during the night-time settlement window and during the Real-time Settlement. When several unsettled instructions are optimised together and a chain of instructions is submitted for settlement, T2S includes the securities and cash received during the process of settling the relevant chain of instructions in the optimisation process.

During the night-time settlement window, the T2S optimisation procedure covers all instructions submitted for settlement (either new instructions or recycled instructions that could not be settled when previously attempted).

During the Real-time Settlement, T2S optimisation procedure runs in parallel to Real-time

T2S Framework Agreement

Schedule 5 – T2S Service Description

Settlement processes and covers instructions that could not be settled when previously attempted.

When necessary, T2S combines the four optimisation procedures described below (technical netting/ optimisation algorithms, prioritisation, partial settlement and auto-collateralisation).

4.6.1 T2S SD.SETT 061: Technical netting and optimisation algorithms service component

The technical netting is intended to limit the resources necessary for the settlement of a set of instructions submitted together for settlement. Without prejudice to the fact that booking takes place on a gross basis, T2S reduces, through technical netting, the final net balance to be credited and debited on Security Accounts and/or Dedicated Cash Accounts. When performing its provision-check, T2S considers the final net balance that results from the booking of all the instructions submitted together for settlement (and not that resulting from each and every individual instruction).

During the night-time settlement window, T2S submits all eligible instructions for settlement and optimises all these instructions together. During day-time, Real-time Settlement optimisation, optimisation algorithms identifying chains of instructions (e.g. such as empty circles, back-to-back instructions) are used to resolve gridlock situations, and to increase the volume and value of settlement and hence, to reduce the value and volume of pending instructions.

4.6.2 T2S SD.SETT 062: Prioritisation service component

Optimisation procedures will take into account the four different priority levels of instructions. T2S automatically assigns predetermined levels of priority for certain specific instructions identified in the Common Reference Data. The four different levels of priority identified are:

1. Reserved priority: Only Signatory CSDs and Central Banks can assign a “reserved priority” for specific instructions such as intraday corporate actions or certain Central Banks’ specific operations related to the provision/ reimbursement of their credit operations.
2. Top priority: T2S automatically assigns top priority to transactions of trading platforms (MTFs, stock exchanges, etc.) with and without CCP and OTC instructions with CCP. To that end, the parameters for identifying transactions (to which this top priority level must be assigned) are predetermined in Common Reference Data and apply by default to all the relevant transactions. T2S does not allow top priority to be assigned to any other category of transactions (either by

T2S Framework Agreement

Schedule 5 – T2S Service Description

default or at a transaction level).

3. High priority: T2S Actors can assign high priority to their settlement instructions;
or
4. Normal priority: T2S assigns normal priority to all other instructions, but enables T2S parties to assign them a high priority on an instruction-by-instruction basis.

For levels 3 and 4 only, the instructing T2S Actor may change the priority level of an instruction (only the deliverer may change normal priority to high priority or high priority to normal priority).

T2S optimises and recycles settlement instructions in accordance with their priority levels in such a way that if several instructions compete for use of the same securities and/or cash resources, for settlement purposes preference is given to the instruction with the highest level of priority. In addition to the priority level, T2S also considers the ISD of the instruction so as to favour the settlement of instructions with the earliest settlement date and thus avoid instructions with low priority not being settled.

For Real-time Settlement, the prioritisation applies only to instructions to be recycled in the settlement queue (i.e. failed instructions). Any increase of a position triggers an optimisation for the International Securities Identification Number (ISIN) concerned. T2S recycles instructions if there is insufficient position.

Furthermore, during the Real-time Settlement, the priority level is taken into account by the settlement procedure only for instructions that failed to settle in a previous settlement attempt. These are subsequently submitted for recycling and optimisation procedures.

4.6.3 T2S SD.SETT 063: Partial settlement service component

T2S uses partial settlement for instructions that could not be settled due to the lack of securities providing the settlement instruction fulfils all criteria for partial settlement. A lack of cash does not trigger partial settlement. Instructions linked by T2S Actors are excluded from partial settlement (see UDFS for further details).

The partial settlement procedure is used for all T2S instructions, unless one of the counterparts indicates at instruction level that partial settlement is not allowed (partial indicator set to no/false), and if the following conditions are met:

- the partial settlement threshold criteria are met, set for both securities and cash, and defined as part of the Common Reference Data; and
- the partial settlement window is active.

When submitting an unsettled instruction for partial settlement, T2S attempts to settle the maximum quantity of securities available on the Security Account of the seller, taking into

T2S Framework Agreement

Schedule 5 – T2S Service Description

account the threshold chosen by the counterparts.

Once partial settlement has been invoked, T2S allows a duly authorised Actor to modify only the priority of the instruction, or to hold, to release or to cancel the pending part of a partially settled instruction. When an instruction is partially settled, T2S does not automatically cancel the original instruction. T2S keeps the original instruction and updates in accordance with the partial settled volumes in the status management.

Reverse collateral instructions are not subject to partial settlement.

T2S uses its own partial settlement parameter to activate and de-activate partial settlement as part of the continuous optimisation process. T2S allows the definition of several T2S parameters for activating and deactivating the partial settlement procedure during the night-time and day-time settlement periods. The T2S partial settlement parameter defines at which moment in time or based on which event T2S activates or de-activates a partial settlement procedure.

In order to minimise fails due to a lack of securities, T2S allows partial settlement in specific time windows, a predefined period before the end of Real-time Settlement and at the end of the last night time cycle during the night-time settlement. T2S submits to partial settlement all eligible instructions that failed to be settled in a previous attempt during the night and deactivates the partial settlement functionality at the closure of the night-time settlement period (see UDFS). T2S submits at least once all those instructions for partial settlement that it has identified as eligible for partial settlement before the partial settlement procedure is deactivated.

T2S informs the CSD and/ or the DCP when partial settlement occurs, depending on the message subscription preferences.

4.6.4 T2S SD.SETT 064: Auto-collateralisation service component

T2S provides auto-collateralisation functionality during the whole T2S settlement period in order to facilitate the settlement of underlying securities-related instructions that would fail to settle due to a lack of cash on a Dedicated Cash Account (DCA) and/or insufficient external guarantee headroom on a Credit Memorandum Balance (CMB)³. T2S provides the auto-collateralisation service on the basis of the list of eligible collateral, relevant prices and limits provided by the Central Banks and Payment Banks.

³ Further described in the relevant chapter of the Liquidity Management Services below.

T2S Framework Agreement

Schedule 5 – T2S Service Description

The auto-collateralisation functionality with Central Banks and with Payment Banks is available to eligible T2S parties as defined in Common Reference Data, provided that auto-collateralisation headroom is available. T2S triggers auto-collateralisation with Central Banks in case of lack of cash on the T2S DCA of the Payment Bank to which the settlement instruction is referring. T2S triggers auto-collateralisation with a Payment Bank (client-collateralisation) in the event of insufficient external guarantee headroom on the CMB of a client of the Payment Bank, that owns the Security Account to which the settlement instruction refers.

T2S allows collateral provided for intraday credit provision in CeBM through auto-collateralisation to be pledged or transferred to a separate account (in accordance with the legal framework chosen by the relevant Central Banks). Collateral provided for auto-collateralisation with Payment Banks can only be transferred to a separate account of the Payment Bank. Intraday credit granted in CeBM through auto-collateralisation can be used only for the settlement of the underlying instructions. The credit amount provided is equal or less than the collateral value of the securities used as collateral, the collateral value being the price provided for a certain security multiplied by the number or nominal amount of the security concerned.

Depending on whether a close link exists between the credit consumer and the security eligible to Central Bank or Payment Bank auto-collateralisation, T2S applies the following prices for the asset valuation:

- Valuation for securities not under close link by applying the valuation price (standard haircut).
- Valuation for securities under close link by applying the own-use valuation price (additional haircut)⁴.

It must be noted that T2S auto-collateralisation service excludes the securities under close links for which the own-used valuation price has not been defined.

If in presence of a close link the own-used valuation price has been defined for the security, T2S auto-collateralisation service accepts the security as collateral and applies the own-used valuation price.

An intraday credit provision through auto-collateralisation is always fully collateralised in

⁴ The valuation with the own-used valuation price of the securities subject to close links will be effective only after the Eurosystem Collateral Management System (ECMS) deployment.

T2S Framework Agreement

Schedule 5 – T2S Service Description

T2S

- Either with securities already held by the buyer via collateral-on-stock, or
- Through collateral-on-flow via the eligible securities that are being purchased.

These securities must be recognised as eligible collateral by Central Banks or Payment Banks and the relevant Payment Bank or its clients must earmark them for their use as collateral. Duly authorised T2S Actor may also earmark a Security Account from which securities may be used for auto-collateralisation. The security account holding the earmarked securities must be linked to the DCA opened by the Central Bank.

In order to provide intraday credit through auto-collateralisation in T2S to one or several eligible Payment Banks, each Central Bank has to open a T2S Central Bank cash account on which all debits corresponding to its intraday credit provisions through auto-collateralisation will be posted. The T2S Central Bank cash account is allowed to have a negative cash balance.

The Payment Banks must open one Security Account (via their CSD) dedicated to auto-collateralisation for each of their clients. T2S uses these accounts when transferring the collateral from the client to the Payment Bank. If allowed by the respective Central Bank, the Payment Banks may use the securities positions received during the client-collateralisation procedure as collateral for auto-collateralisation procedure with the Central Banks. In such cases, the Payment Bank has the option to either earmark the Security Accounts for auto-collateralisation purpose only or earmark specific securities positions in the Security Account for auto-collateralisation. The Payment Bank will be able to use such Security Accounts for both (a) receiving collateral in case of client-collateralisation (b) and providing collateral for auto-collateralisation with Central Banks.

Each Central Bank is required to determine in Common Reference Data the collateralisation procedure for which it opts, i.e. (i) transfer to an account opened in the Central Bank's name, or (ii) transfer to an account pledged in its favour, or (iii) reservation of securities. This must be done for all eligible Payment Banks to which the relevant Central Bank provides intraday credit through auto-collateralisation.

For each of their Security Accounts, T2S parties may indicate via the T2S earmarking service whether T2S may use securities from that account when generating auto-collateralisation operations with Central Banks or Payment Banks on a specific T2S DCA. When such a link exists between a Security Account and a T2S DCA, T2S will use securities from that account in auto-collateralisation operations with either Central Bank, or with the Payment Bank (acting as credit provider), depending on the earmarking options.

T2S Framework Agreement

Schedule 5 – T2S Service Description

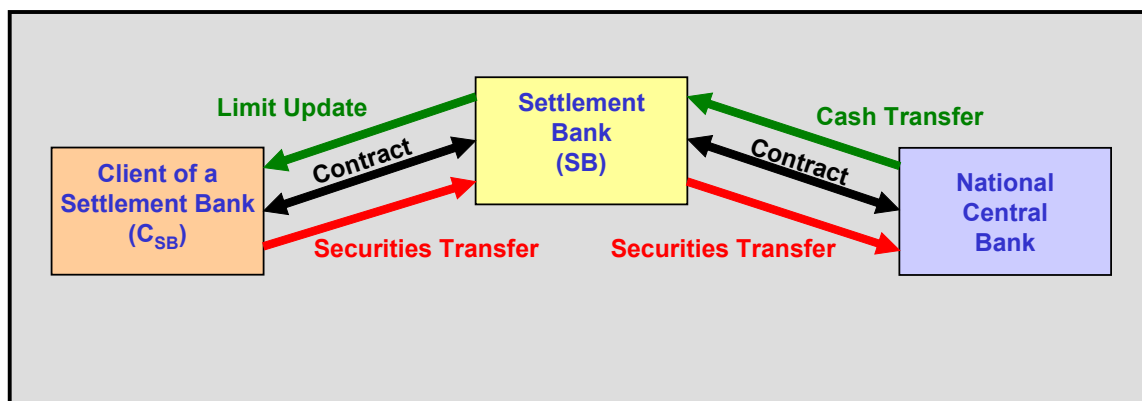

T2S generates auto-collateralisation operations only when they allow the settlement of the underlying settlement transaction(s) and when sufficient headroom exists on the auto-collateralisation limit. When triggering auto-collateralisation, T2S also considers the unsecured credit limit headroom available that could complement the auto-collateralisation operation in the event of auto-collateralisation with Payment Banks (client-collateralisation). Each Central Bank and each Payment Bank is able to increase or decrease at any moment of the Settlement Day the auto-collateralisation limit of an eligible Payment Bank or client of the Payment Bank.

T2S submits auto-collateralisation instructions for settlement on an all-or-none basis together with the underlying settlement instructions in order to ensure that the amount of intraday credit provided through auto-collateralisation is automatically and exclusively used to settle the underlying instruction(s).

On the basis of the type of collateral movement chosen by each Central Bank providing credit, T2S will collateralise the intraday credit provided through auto-collateralisation either:

- by transferring the securities from the Security Account of a T2S Actor to the Security Account of the Central Bank providing the credit;
- by transferring the securities from the account of the bank receiving the credit to another account of this Payment Bank (the second Security Account being pledged to the Central Bank providing the credit where the securities are in the name of the bank receiving the credit); or
- by blocking the securities on the Security Account of the Payment Bank receiving the credit; in such a case, the securities will be blocked in favour of the Central Bank providing the credit and T2S will not allow the Security Account holder to use the relevant securities as long as they are blocked.

When auto-collateralisation on flow and on stock are both possible for the settlement of a transaction or a set of transactions, T2S prefers to resorts to auto-collateralisation on flow

T2S Framework Agreement

Schedule 5 – T2S Service Description

before auto-collateralisation on stock. When the collateral value of the securities on flow is not sufficient to cover the amount of credit granted, T2S complements collateral on flow with collateral on stock. Finally, when securities being purchased in the underlying transaction are not eligible collateral (e.g. equities for Eurosystem intraday credit) and therefore cannot be used as collateral on flow, T2S uses collateral on stock to secure the amount of intraday credit granted through auto-collateralisation.

Whenever T2S generates and settles an auto-collateralisation operation, it creates and sets on hold the reimbursement of that auto-collateralisation operation - and the exact reverse operation (i.e. same amounts, same accounts, etc). The Payment Banks are able to trigger the reimbursement of their auto-collateralisation operations with Central Banks and with their clients at any moment during the daytime Real-time Settlement by releasing the relevant on hold reimbursement instructions.

Auto-collateralisation provides intraday credit that must be repaid at the end of the day. T2S uses all available liquidity on the cash accounts of the Payment Bank to repay the credit. In normal situations, the Payment Banks have repaid all intraday credit operations with the Central Banks before the auto-collateralisation reimbursement is initiated. If this is the case, T2S executes only a cash sweep during which the excess liquidity on the Payment Bank's cash accounts is transferred to the relevant Real-Time Gross Settlement (RTGS) systems. If, however, there is not sufficient liquidity on the cash account at the end of the day to fully reimburse the pending intraday credit, special end of day procedures are invoked. The automated cash sweep at the end of day is optional for dedicated cash accounts in the euro area.

The securities that are held on the accounts of the Central Bank (or pledged) for auto-collateralisation purposes are transferred to the overnight collateral Security Account indicated by the Central Bank. At the same time, the relevant collateral management system is informed of the move and the credit usage limit for the participant in the RTGS system is increased. This process ensures that the T2S service provides, though a collateralised credit, the same amount of liquidity in the RTGS system as it withdraws⁵.

⁵ Further details especially on the reimbursement procedures and rules can be found in the User detailed Functional Specifications, especially chapter 1.1.2 Liquidity management, and in the General Functional Specifications (GFS), especially chapter 2.3.5 Liquidity Management

T2S Framework Agreement

Schedule 5 – T2S Service Description

4.7 T2S SD.SETT 070: Realignment service

When T2S matches a pair of settlement instructions, or receives an already matched pair of instructions, it verifies whether the instructions submitted require realignment instructions on accounts other than those of the T2S Parties submitting the instructions (e.g. on the accounts of the Issuer CSD). If T2S identifies a need to realign, it generates the required realignment instructions, on the basis of the cross-CSD links in the Common Reference Data, automatically validates the realignment instruction, and links all settlement instructions to ensure all-or-none settlement.

If the Issuer CSD is within T2S and the Investor CSDs are not in T2S, the realignment takes place in T2S on the basis of settlement instructions (usually free-of-payment) to be sent by the Issuer CSD.

T2S does not send realignment instructions to the Issuer CSD if the Issuer CSD is outside T2S:

- The realignment process is handled by the Investor CSDs in coordination with the Issuer CSD outside T2S.
- If at least one Investor CSD is within T2S, the Conditional Securities Delivery (CoSD) mechanism can be used by the Investor CSDs, to block the position in T2S and hold the instruction until the settlement is confirmed in the Issuer CSD's books.

4.8 T2S SD.SETT 080: Instruction recycling service

Recycling occurs in anticipation of finding the required securities and/or cash subsequent settlement runs, so that failed transactions can be settled successfully.

Recycling differs slightly depending on whether it occurs during day-time and night-time settlement. In case of night-time settlement, all unsettled settlement instructions are recycled automatically to the next settlement sequence. In day-time settlement, unsettled settlement instructions are recycled when new settlement resources (i.e. securities and/or cash) become available.

Unmatched pending instructions are recycled for 20 business days before cancellation by T2S. Matched pending instructions which fail to settle are recycled for a period of 60 business days, after which they are cancelled by T2S (see UDFS for further details on the recycling period and its value).

The T2S settlement optimisation techniques reduce the number of unsettled settlement instructions at the end of the settlement day (EOD).

4.9 T2S SD.SETT 090: Instruction amendment service

T2S Actors may amend only process indicators, irrespective of the status of the underlying settlement instruction (except for instructions with an end-of-life status). The instructing T2S Party has to cancel and reinstruct the settlement if it wishes to modify any other fields.

T2S allows the amendment of the following process indicators until settlement occurs:

- partial settlement (only for settlement instructions);
- linking instructions; and
- settlement priority.

In case of partially settled instructions, the instructing T2S Party may amend the settlement priority only for the pending part of partially settled instructions.

T2S does not allow any settled or cancelled settlement instruction to be modified.

T2S will reject an amendment sent by a CSD participant other than the T2S Party which submitted the original instruction concerned, or its CSD, if the instruction to be amended was sent as non-modifiable by the CSD or an authorised CSD participant.

T2S informs the instructing T2S Party, as well as any T2S Actor duly authorised to access this information, immediately after the successful amendment of an instruction, in accordance with their message subscription preferences.

If the amendment process fails in T2S, then the amendment instruction is rejected. (e.g. original instruction has settled.)

T2S Framework Agreement

Schedule 5 – T2S Service Description

4.10 T2S SD.SETT 100: Instruction cancellation service

Any instructing T2S Actor or its CSD may cancel its settlement instructions unilaterally prior to Matching or its settlement restrictions prior to settlement. In such case, T2S verifies that (a) the instruction that the T2S Actor wishes to cancel exists in T2S and that (b) its cancellation is possible. Whether or not T2S Actors are able to cancel their instructions depends on the status of the instruction.

T2S will reject any cancellation request sent by a CSD participant other than the T2S Party which submitted the original instruction concerned, or its CSD, if the instruction to be cancelled has been sent as non-modifiable by the CSD or an authorised CSD participant.

Under the same rules, a CSD may cancel any instruction of any of “its DCPs”. Cancellation instructions cannot be cancelled.

Until Matching has occurred, T2S allows a T2S Actor to request unilaterally the cancellation of settlement instructions only.

Once Matching has occurred, T2S Actors may cancel matched settlement instructions only bilaterally, i.e. both parties must send a cancellation instruction (“binding matching”) for the cancellation to take effect. T2S then matches the cancellation instructions and cancels both settlement instructions.

In the case of bilateral cancellation of settlement instructions, T2S checks whether the cancellation instruction from the counterpart exists and matches the two cancellation instructions. If the counterpart cancellation instruction does not exist, then the cancellation instruction remains pending until it matches with a valid counterpart cancellation instruction. T2S also accepts already matched cancellation instructions to cancel an instruction previously sent as already matched.

In the case of a Conditional Settlement (CoSD), T2S allows only the administering T2S Party identified in the Common Reference Data to unilaterally request the cancellation of the instruction that triggered the CoSD process (e.g. when the external condition for settlement is not fulfilled), even after T2S has blocked the relevant securities holding for a CoSD. If a CoSD involves more than one administering T2S Party, the CoSD settlement instruction cannot be cancelled unless T2S receives cancellation instructions from each administering T2S Party involved in the initial settlement instruction.

T2S notifies the originator of a cancellation instruction when the cancellation instruction has either been executed (i.e. cancellation of the settlement instruction was successful) or denied (i.e. settlement instruction could not be cancelled). In the latter case, the resulting cancellation status value for the cancellation instruction is “denied”.

T2S Framework Agreement

Schedule 5 – T2S Service Description

If the cancellation process in T2S fails, then the cancellation instruction goes through recycling until it is either processed or rejected if the original instruction has already settled.

If the cancellation mechanism is automatically activated by T2S for a given instruction, T2S informs the CSD or the DCP that the instruction was cancelled by T2S. Automatic cancellation rules are applied to invalid or unmatched or failed/outdated instructions, and are compliant with ECSDA recommendations.

T2S generated realignment instructions cannot be cancelled by any T2S Actor.

4.11 T2S SD.SETT 110: Hold/release service

Hold and release mechanisms allow T2S Actors to hold or release settlement instructions until their actual settlement or cancellation, even beyond their Intended Settlement Date (ISD). These mechanisms give T2S Actors the flexibility to delay the settlement. T2S Actors may send maintenance instructions to hold and release settlement instructions as many times as required.

Under certain conditions, it is also possible to release just a part of the quantity of a transaction. This partial release mechanism allows a CSD participant to amend the original instruction to specify the quantity to be released.

T2S allows only the T2S Actor that has put an instruction on hold to release it. If there are two executed hold instructions for the same instruction (i.e. one from the CSD participant and one from the CSD), release instructions must also come from both. If T2S receives a hold instruction for a settlement instruction that is already on hold or has been cancelled from the same T2S Actor who has submitted the initial hold or cancellation instruction, T2S denies the hold instruction.

T2S will reject any hold/release instruction sent by a CSD participant other than the T2S Party which submitted the original instruction, or its CSD, if the instruction to be held/released was sent as non-modifiable by the CSD or an authorised CSD participant.

All instructions on hold at the end of the ISD remain unsettled and T2S recycles them in accordance with the T2S rules for recycling instructions. Furthermore, T2S allows the remaining part of partially settled instructions to be held and to be released. All partially released instructions, which remain unsettled at the end of day, are automatically cancelled and the remaining to be settled quantity is put on hold.

T2S will reject any hold or release settlement instruction if T2S has already settled or cancelled the underlying settlement instruction. T2S informs the instructing T2S Party accordingly, depending on its message subscription preferences.

T2S Framework Agreement

Schedule 5 – T2S Service Description

4.12 T2S SD.SETT 120: Earmarking, blocking and reservation service

4.12.1 T2S SD.SETT 121: Earmarking service component

In T2S Parties may define that a security position or a security account be earmarked as a settlement restriction.

A T2S Actor may earmark a position or an account for a specific purpose such as auto-collateralisation. If there is a conflict regarding use of the earmarked securities for a delivery/ receipt owing to contradictory choices between account level and instruction level (that is to say when a settlement instruction refers to an earmarking purpose which is different from that at account level), the choice at account level overrides the choice at position level (T2S will credit or debit the earmarked position according to the purpose at account level and not according to the purpose at the instruction level). If earmarking is done at the Security Account level for a specific purpose, it will not be possible to earmark securities at position level (in the same account), for a different purpose.

Earmarking is not possible for DCAs.

4.12.2 T2S SD.SETT 122: Blocking service component

In addition to earmarking, T2S Parties may block securities or cash using settlement restrictions. Also via a reference data maintenance it is possible to block Securities Account, DCA and Party in order to prevent settlement. A T2S Actor may block securities or cash for a specific purpose. For the securities or cash to be unblocked, the relevant instruction must contain the reference to the specific purpose.

A blocking of cash or securities prevents the transfer of specific securities/cash from a specific Security Account/T2S DCA.

When a blocking restriction is submitted for settlement, and provided sufficient securities and/or cash are available on the relevant accounts, T2S blocks the number of securities and/or the amount of cash specified in the settlement restriction on the relevant securities and/or T2S DCA(s). If insufficient securities and/or cash are available given that no partial settlement is allowed then the blocking will be recycled until full settlement can occur.

4.12.3 T2S SD.SETT 123: Reservation service component

As a further settlement restriction, T2S Parties may reserve securities or cash. A T2S Actor may create a reservation without having all the securities or cash specified in the reservation. Any securities or cash arriving will be attributed to the reservation until the reserved volume has been reached.

When a reservation instruction is submitted for settlement, and provided sufficient securities and/or cash are available on the relevant account(s), T2S reserves the number

T2S Framework Agreement

Schedule 5 – T2S Service Description

of securities and/or the amount of cash specified in the settlement instruction on the relevant securities and/or T2S DCA(s). If insufficient securities and/or cash are available, T2S:

- reserves the securities and/or the cash already available on the relevant account; and
- supplements it with any incoming securities and/or cash proceeds arriving on this account, provided that the latter are not defined to be used for any other purpose.

A reservation of cash or securities reserves a securities or cash position for the settlement of one or more settlement instructions. A T2S Actor may refer to an existing reservation in another settlement instruction, by means of the reservation's unique reference number. If such references result is made the provisioning process will include the reserved cash or securities in its provisioning check. The reserved securities/cash will be used first (ahead of unreserved securities/cash) for settlement of the instruction.

4.12.4 T2S SD.SETT 123: Common features of the earmarking, blocking and reservation service component

When several reservations/blockings of securities and/or cash have been performed on the same Security Account and/or T2S DCA, and a T2S Actor submits to T2S a settlement instruction referring to one (or some) of those reservation/blocking instructions, the T2S provision-check does not consider the additional securities and/or cash reserved/blocked through reservation instructions other than those referred to in the instruction being settled. However, if the securities/ cash reserved/ blocked are not sufficient, T2S also takes into account additional securities and/or cash available on the relevant Security Account and T2S DCAs, provided that the latter have not been reserved/blocked for any other purpose.

If at EOD the reserved and blocked cash has not been used for any purpose, T2S releases the relevant cash. In case of a CoSD blocking, T2S releases the blocked cash at the EOD and creates a new CoSD blocking instruction. As regards securities, if blocked or reserved securities have not been used or released at EOD as a result of an instruction from the relevant T2S Actor, T2S does not release them automatically.

T2S Framework Agreement

Schedule 5 – T2S Service Description

4.13 T2S SD.SETT 140: Conditional Security Delivery (CoSD) service

Conditional Security Delivery (CoSD) is a special functionality which manages instructions that require the fulfilment of a settlement condition outside T2S before securities may be settled in T2S⁶.

It is the responsibility of the CSD to set up, maintain and administrate the CoSD rule-based model and process. These rules are stored as part of the Common Reference Data in T2S. Each rule identifies an administering T2S Party to release the instruction for settlement or to cancel the CoSD flagged settlement instruction and determines events which will result in an instruction automatically being submitted to the CoSD functionality by T2S. One settlement instruction might be subject to more than one CoSD rule and in such cases more than one administering T2S Party is assigned to that instruction.

On the ISD, T2S verifies all instructions with that particular ISD in accordance with the CoSD rules. It submits them automatically to the CoSD procedure if one or more CoSD rules are met. In such case, T2S automatically generates a settlement restriction to block the securities position, the cash position, or both.

T2S rejects any cancellation request coming from the instructing parties after the activation of the CoSD process, as only administering parties are allowed to cancel settlement instructions submitted to CoSD.

T2S blocks the securities in the deliverer's Security Account irrespective of the instruction to which the CoSD rule applies (similar rule applies for cash blocking on the T2S DCA linked to the receiver's Security Account). If two or more CoSD rules apply to the securities delivery instruction or related receiving or realignment instructions and those rules require securities to be blocked, the securities are blocked only once. Likewise, T2S blocks cash only once in the delivering cash account.

In a CoSD, securities, cash or both remain blocked and the instruction concerned remains on hold until T2S receives from the administering parties:

- a release instruction, requesting settlement of the instruction using the previously blocked securities or cash (on the basis of the information contained in the initial instruction); or

⁶ Further details can be found in the User Detailed Functional Specifications (UDFS), especially chapters 1.1.1. Settlement, 2.4 Send Settlement Restriction on Securities Position, 2.6 Send Release Instruction for CoSD by Administering Party, and 2.7 Send Cancellation Instruction for CoSD by Administering Party

T2S Framework Agreement

Schedule 5 – T2S Service Description

- a cancellation instruction. After receiving cancellation instruction(s) from all administering parties T2S will cancel the CoSD instruction and its underlying instructions. In such case the underlying cash/securities are unblocked and the administering parties and instructing parties receive a confirmation message.

A “blocking” status message is sent by T2S to inform the (administering) CSD and/or the DCP that the securities, cash or both have been blocked for the processing of the original instruction. A “hold” status message is sent by T2S to inform the (administering) CSD and/or the DCP that the instruction related to the original instruction is prepared for settlement and waiting for release.

Only the administering T2S Party can send the release message. If the receiving party is outside T2S, the status information is relayed by the CSD responsible for the account within T2S.

If the CoSD blocking cannot take place, T2S recycles the blocking instruction for the following Settlement Day. Cash blocked under CoSD is released at the EOD and regenerated for the following Settlement Day. Settlement instruction that are on CoSD Hold are recycled for the following Settlement Day (i.e. securities remain blocked and the settlement instruction remains on hold).

If the realignment chain changes or revalidation of the instruction submitted to CoSD and its related instructions is unsuccessful, T2S cancels all the instructions but the blocked securities/cash remain blocked.

4.14 T2S SD.SETT 150: Linked instructions service

T2S Actors may link instructions in order to ensure that a settlement instruction settles at the same time, before or after another settlement instruction. Linked instructions are possible on a

- one-to-one;
- one-to-many; or
- many-to-many

basis.

When T2S submits several linked instructions for a settlement attempt, it posts the debits and credits for cash and securities from the relevant transactions if the provision check (including account netting effects) is successful. T2S settles sets of linked instructions according to the highest level of priority accorded to any of the instructions within the set (the whole set of linked instructions settles according to this level of priority).

T2S Framework Agreement

Schedule 5 – T2S Service Description

T2S Actors can link instructions by using the ISO settlement link indicators “AFTER”, “BEFORE” and “WITH”. These link indicators will be used in the settlement process. It is also possible to link by using a pool reference, which behaves from a settlement point of view as a WITH link. In addition, the T2S Actors can use the INFO link, which has no impact on the settlement processing.

When T2S receives an instruction which is linked to one or more other instruction(s), it:

1. Checks that the linked instruction(s) exist.
2. Then validates that the information contained in the new linked instruction is consistent with the instruction which exists and to which it is linked, i.e. the ISD and the Security Account holder used are the same.

Linked instructions are excluded from partial settlement. If at EOD a linked instruction has not been settled it will be recycled.

4.15 T2S SD.SETT 160: Corporate actions service

To support the CSDs in settling corporate action entitlements, T2S uses standard settlement services for security settlement as well as liquidity management/cash settlement.

4.16 T2S.SD.SETT 170: Penalty Mechanism service

Regulation (EU) 909/2014 (CSDR), mandates the implementation of a settlement discipline framework that includes obligations for CSDs to establish procedures that facilitate and promote timely settlement of transactions. These procedures include the application of cash penalties for matched settlement instructions that have not settled on their Intended Settlement Date (ISD). In order to support CSDs in their compliance to the CSDR, T2S provides a Penalty Mechanism service that consists of three service components:

- Cash penalties identification service component
- Cash penalties computation service component
- Cash penalties adjustment service component

Note: the settlement of cash penalties, i.e. collection and re-distribution of the payments related to cash penalties, is out of scope of the T2S Penalty Mechanism service.

4.16.1 T2S.SD.SETT 171: Cash penalties identification service component

The initial process in the T2S Penalty Mechanism service is the identification of settlement instructions eligible for cash penalties, performed on a daily basis by T2S, i.e. every Settlement Day.

The application of cash penalties is restricted to a specific scope of:

- Financial instruments: a list of securities eligible for cash penalties is maintained in T2S. CSDs are responsible to feed and maintain this list in T2S on a daily basis.
- Transaction types: all transactions types can be eligible for cash penalties, except transactions for the settlement of corporate actions on stock.
- Instruction types: all settlement instruction types sent by T2S Actors are in scope of cash penalties, i.e.:
 - DVP/RVP: deliver or receipt versus payment;
 - DWP/RWP: deliver or receipt with payment;
 - DFP/RFP: deliver or receipt Free of Payment;
 - DPFOD/CPFOD: Payment Free of Delivery debit or credit.

T2S generated realignment settlement instructions as well as all Intra-Position and Intra-Balance restriction movements are out of scope of cash penalties.

- Instruction lifecycle: only matched settlement instructions are considered for cash penalties. Additionally, in order to derive whether a cash penalty is to be

T2S Framework Agreement

Schedule 5 – T2S Service Description

computed, T2S performs further eligibility checks taking into account the ISD, applicable settlement cut-off, statuses and reasons for non-successful settlement of the settlement instruction, as well as the details of the counterpart matched instruction.

In line with the CSDR, T2S distinguishes between two types of cash penalties:

- **Settlement Fail Penalties (SEFP):** penalise a non-execution or failure of settlement after the completion of the settlement processing of the relevant cut-off on or after ISD. A SEFP is computed for each Settlement Day where the settlement instruction fails to settle in T2S. Every reason for non-successful settlement associated to the settlement instruction (and not to the counterpart instruction) is considered by T2S for its eligibility for a SEFP, it does not matter whether a settlement instruction has failed to settle for e.g. lack of securities or lack of cash, or if it has not been submitted to settlement due to e.g. being on hold.
- **Late Matching Fail Penalties (LMFP):** penalise the late sending of settlement instructions that prevents timely settlement of a transaction. Only one LMFP can be calculated for a given settlement instruction, i.e. on the Settlement Day when it is matched in T2S, but it considers all the previous days where the instruction did not settle due to the late Matching of the instruction. A settlement instruction is eligible for a LMFP when it is matched in T2S at a point in time when it is no longer possible to settle it on ISD and has an accepted timestamp in T2S greater than its counterpart instruction.

For each cash penalty identified, T2S determines the failing and the non-failing party, respectively the party to be debited with the penalty and the party to be credited with the penalty. This information is stored in T2S and used for reporting purposes. T2S uses the following logic to derive the failing party for a cash penalty:

- As a general rule, the T2S Actor specified as account operator (as described in “Security Account data service”) of the Securities Account of the underlying settlement instruction for which the cash penalty is computed is considered as the failing party, whereas the non-failing party will be the T2S Actor specified as account operator of the Securities Account of the counterpart’s settlement instruction, except;
- In case the cash penalty is a LMFP and the settlement instructions are sent to T2S as already matched, T2S will consider the instructing party of the underlying already matched instruction as both the failing and the non-failing party, as T2S cannot derive which counterpart is responsible for the late Matching. This logic is

T2S Framework Agreement

Schedule 5 – T2S Service Description

implemented under the assumption that the instructing party is best suited to reconcile and re-allocate the penalty to the correct client with information available outside T2S. The instructing party shall request its CSD to re-allocate the cash penalty in T2S with the ad-hoc functionality (see “Cash penalties adjustment service component”).

4.16.2 T2S.SD.SETT 172: Cash penalties computation service component

T2S performs the computation of cash penalties applicable for every Settlement Day on the following Settlement Day. Once it has determined that a settlement instruction is eligible for LMFP or SEFP, T2S computes the amount of cash penalties according to parameters defined for each T2S instruction type as summarised in the following table (see UDFS for further details):

T2S Framework Agreement

Schedule 5 – T2S Service Description

Type of Settlement Instruction	Parameters used for the computation of cash penalties
Delivering versus Payment (DVP) Delivering Free of Payment (DFP) Receiving Free of Payment (RFP)	Penalty based on the reference price of the ISIN, quantity of securities failed to be delivered, and penalty rate of the relevant asset type.
Receiving versus Payment (RVP)	Penalty based on the reference price of the ISIN, quantity of securities failed to be delivered, and the cash penalty rate (discount rate of the relevant currency).
Debiting Payment Free of Delivery (DPFOD) Crediting Payment Free of Delivery (CPFOD)	Penalty based on the amount of cash failed to be delivered and the cash penalty rate (discount rate of the relevant currency).
Delivery with Payment (DWP) Receiving with Payment (RWP)	Penalty will be the sum of: - The penalty based on the reference price of the ISIN, the quantity of securities failed to be delivered, and penalty rate of the relevant asset type, and; - The penalty based on the amount of cash failed to be delivered and the cash penalty rate (discount rate of the currency).

For the computation of a LMFP, T2S considers each Settlement Day where the settlement instruction was due to settle according to the T2S calendar, i.e. since the ISD. Hence, the LMFP shall be the sum of the amounts calculated for each of the relevant Settlement Days identified, using the reference prices of the applicable day.

T2S computes the amount of cash penalties in T2S settlement currencies:

- For settlement instructions versus payment, in the currency of the cash leg of the transaction. If the reference price of the ISIN is in a different currency, the Euro foreign exchange rates of the ECB are used to convert the penalty.
- For settlement instructions Free of Payment, in the currency of the reference price of the ISIN as long as it is a non-Euro T2S settlement currency and the CSD of

T2S Framework Agreement

Schedule 5 – T2S Service Description

the failing party and the CSD of the non-failing party are both in the “*List of CSDs with penalty computation in non-Euro settlement currencies for FOPs*”, and in Euro otherwise. If the reference price of the ISIN is in a currency that is not a T2S settlement currency, the Euro foreign exchange rate of the ECB are used to convert the penalty.

Newly computed cash penalties are then made available to the relevant T2S Actors in push or pull mode via the daily penalty list (See “Report Generation service”) as soon as the calculation process is performed. Each cash penalty is informed twice, once for the failing party (with debit indicator) and once for the non-failing party (with credit indicator). It includes cash penalty identification and details except price data, as well as underlying settlement instruction details. Newly computed cash penalties are also available in User-to-Application (See “Query Service for CSDs service component”) once all the daily calculation and recalculation process have finished.

4.16.3 T2S.SD.SETT 173: Cash penalties adjustment service component

T2S provides the possibility to CSDs to perform adjustments on computed cash penalties for a given month, until the end of the appeal period on the following month (as further detailed in the UDFS). CSDs are able to perform the following actions in User-to-Application or Application-to-Application mode:

- Remove a cash penalty;
- Re-include a previously removed cash penalty;
- Re-allocate a cash penalty from the instructing party to the delivering or receiving party;
- Switch the failing and non-failing party of a cash party;
- Update erroneous reference data that was used for the computation of a cash penalty, e.g. the reference price or the attributes of an ISIN eligible for penalties

In all except the first case (removal), T2S automatically recalculates cash penalties impacted by the adjustment(s), which is then made available to the relevant T2S Actors in push or pull mode via the list of modified cash penalties (See “Report Generation service”), or in User-to-Application (See “Query Service for CSDs service component”) as soon as the recalculation process is performed. T2S performs the recalculation of cash penalties on a daily basis, i.e. every Settlement Day.

5 T2S SD.LIM: Liquidity Management Service Class

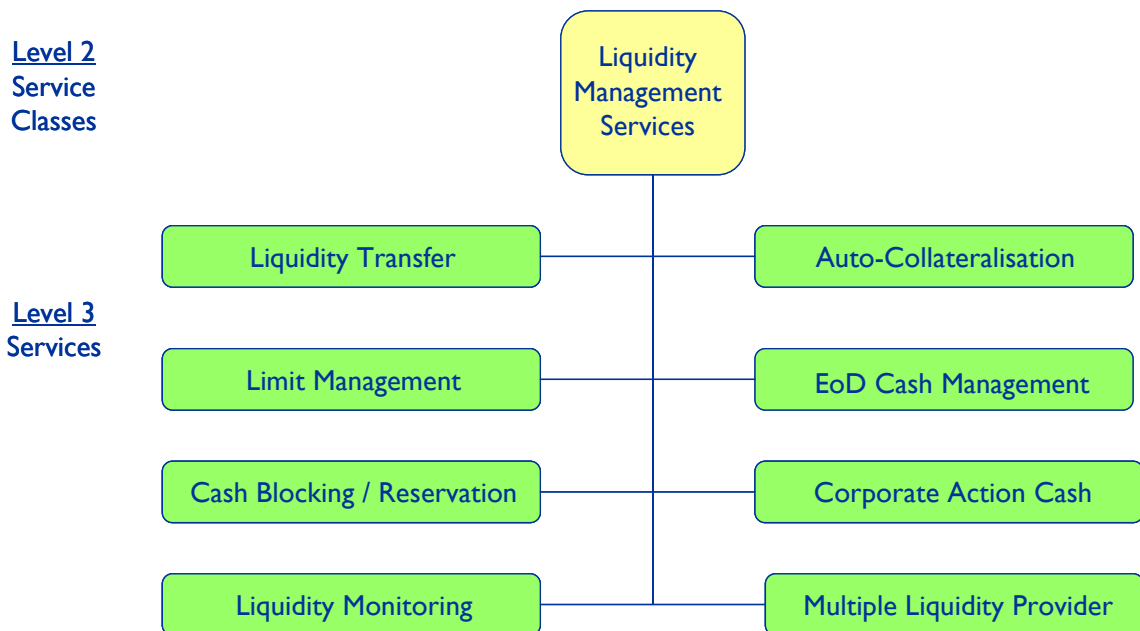

5.1 T2S SD.LIM 010: Liquidity transfer service

A liquidity transfer in T2S is an instruction from a DCA holder to transfer a specified amount of cash balance from its cash account to another cash account. The T2S DCA holders are Payment Banks or Central Banks.

T2S allows a T2S DCA holder to receive liquidity on its T2S DCA(s) from any External RTGS Account, MCA, RTGS DCA, TIPS DCA, RTGS CB account or CLM CB account (provided that they are denominated in the same currency and that this is permitted by the relevant Central Bank). In the same way, T2S allows the holder of the T2S DCA to send liquidity from its T2S DCA(s) to any External RTGS Account, MCA, RTGS DCA, TIPS DCA, RTGS CB account or CLM CB account (as setup by the relevant Central Bank in T2S) if the currency is the same.

In addition to liquidity transfers between External RTGS Account, MCA, RTGS DCA, TIPS DCA, RTGS CB account or CLM CB account and T2S DCAs as mentioned above, T2S provides T2S DCA holders with a “multiple liquidity providers” functionality, i.e. T2S DCA holders can receive liquidity from and reimburse to several RTGS accounts.

Immediate liquidity transfers are executed in real time upon receipt. During the execution of the liquidity transfer, if the status of the liquidity Transfer Order changes, T2S informs the T2S Actor about the new status if the latter’s message subscription rules in the Common Reference Data so dictate.

T2S Framework Agreement

Schedule 5 – T2S Service Description

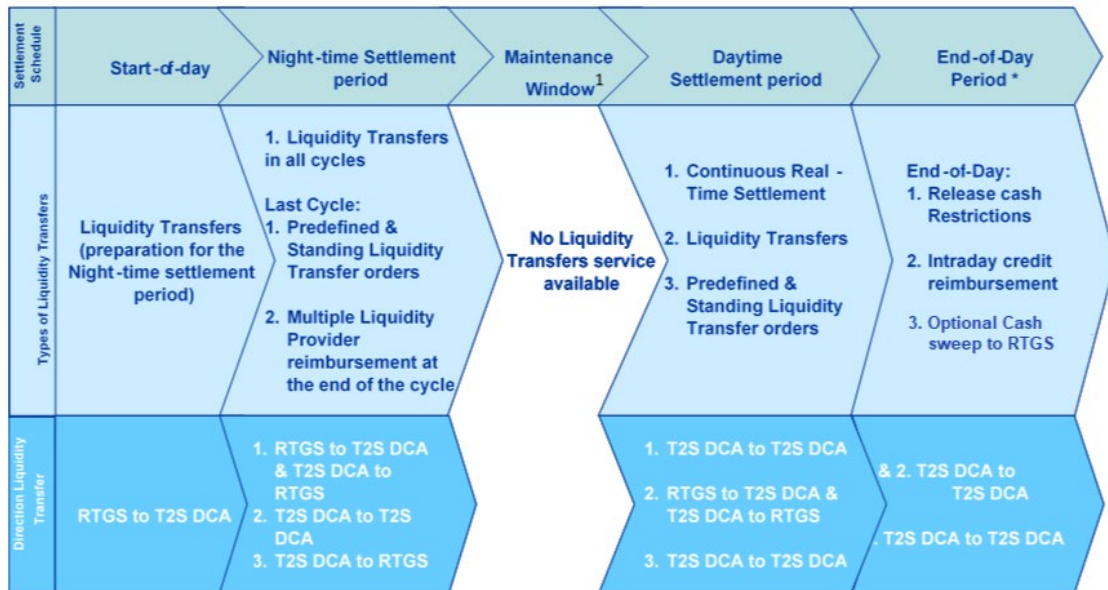

1. Maintenance Window is Optional during the week and mandatory during weekends.

T2S supports three types of liquidity transfers between T2S DCAs and External RTGS Account, MCA, RTGS DCA, TIPS DCA, RTGS CB account or CLM CB account.

- Immediate liquidity Transfer Order:
 - Liquidity is transferred in real time on receipt of the instruction from the account holder or a T2S Party with the appropriate rights.
 - Used to transfer liquidity between a T2S DCA and the External RTGS Account, MCA, RTGS DCA, TIPS DCA, RTGS CB account or CLM CB account or between two T2S DCAs (if these DCA belong to the same Payment Bank or are linked to the same RTGS account or MCA).
 - If an immediate liquidity Transfer Order cannot be settled, an alert is sent to the Payment Bank that initiated the transfer in line with the message subscription rules in the Common Reference Data.
- Pre-defined liquidity Transfer Order:
 - Liquidity is transferred at a certain time or when a particular business event occurs, as defined by the account holder of the account or a T2S Actor with appropriate rights to debit the account.
 - The transfer is executed only once on the basis of a defined time or event.
 - Liquidity is transferred from a T2S DCA to an External RTGS Account,

T2S Framework Agreement

Schedule 5 – T2S Service Description

MCA, RTGS DCA, TIPS DCA, RTGS CB account or CLM CB account only (either the specified transfer amount or “all cash” available in the T2S DCA will be transferred).

- Any duly authorised T2S Actor may amend or delete the predefined liquidity Transfer Order.
- Standing liquidity Transfer Order:
 - Liquidity is transferred at a certain time or when a particular business event occurs, as defined by the account holder of the account or a T2S Party with appropriate rights to debit the account.
 - The transfer is executed whenever the event in question occurs until the standing order is deleted.
 - Liquidity is transferred from a T2S DCA to an External RTGS Account, MCA, RTGS DCA, TIPS DCA, RTGS CB account or CLM CB account only (either the specified transfer amount or “all cash” available in the T2S DCA will be transferred).
 - Any duly authorised T2S Actor may amend or delete a standing liquidity Transfer Order.

If insufficient liquidity is available on the accounts to be debited, T2S allows partial execution in the case of pre-defined/ standing liquidity transfers. T2S allows a partial execution of an immediate liquidity transfer only if it is instructed by a party acting on behalf of the Payment Bank.

As part of the business validation process, T2S checks that the content of immediate liquidity Transfer Orders (received from T2S Actors) or liquidity transfer orders (which have been generated from a standing or predefined liquidity order) is correct, and validates the consistency of the data contained in the immediate liquidity transfer received by T2S with the Common Reference Data. A liquidity transfer which has been generated from a standing or predefined liquidity Transfer Order is not validated by T2S.

After business validation, T2S communicates the acceptance/ rejection of a liquidity Transfer Order to the Payment Bank and to the Central Bank if the liquidity Transfer Order was sent from the RTGS system. In the event of failure or rejection, T2S sends a list of error/ reason codes. T2S also communicates all changes in status of a liquidity Transfer Order.

After successful validation the liquidity Transfer Order is sent to the settlement functionality for processing. The booking function updates the balances on the DCAs

T2S Framework Agreement

Schedule 5 – T2S Service Description

involved on a gross basis. In the case of partial execution or of no execution, no further settlement is attempted. T2S communicates all changes in status of a liquidity Transfer Order in the course of its execution in accordance with the message subscription rules in the Common Reference Data, and confirms all executed transfers between T2S and RTGS.

5.2 T2S SD.LIM 020: Limit management service

T2S provides the T2S Actor with different liquidity control mechanisms. A Central Bank can control its parties' T2S DCA by setting an auto-collateralisation limit for the T2S DCA. Payment Banks can also set different limits at the client level and monitor their utilisation.

A Payment Bank can set up different limits for the liquidity provided to each of its clients, either against collateral or without collateralisation. Using T2S queries, the Payment Bank has a consolidated view of its client's collateral holdings at any given point in time across multiple Security Accounts in either the same or different CSDs. The respective limits are automatically updated when used as a part of the settlement process. T2S performs validations to ensure that these limits are not breached. T2S does not allow cash movements between the Payment Bank and its clients in T2S. The only cash in T2S is the cash on the DCA, which is in CeBM.

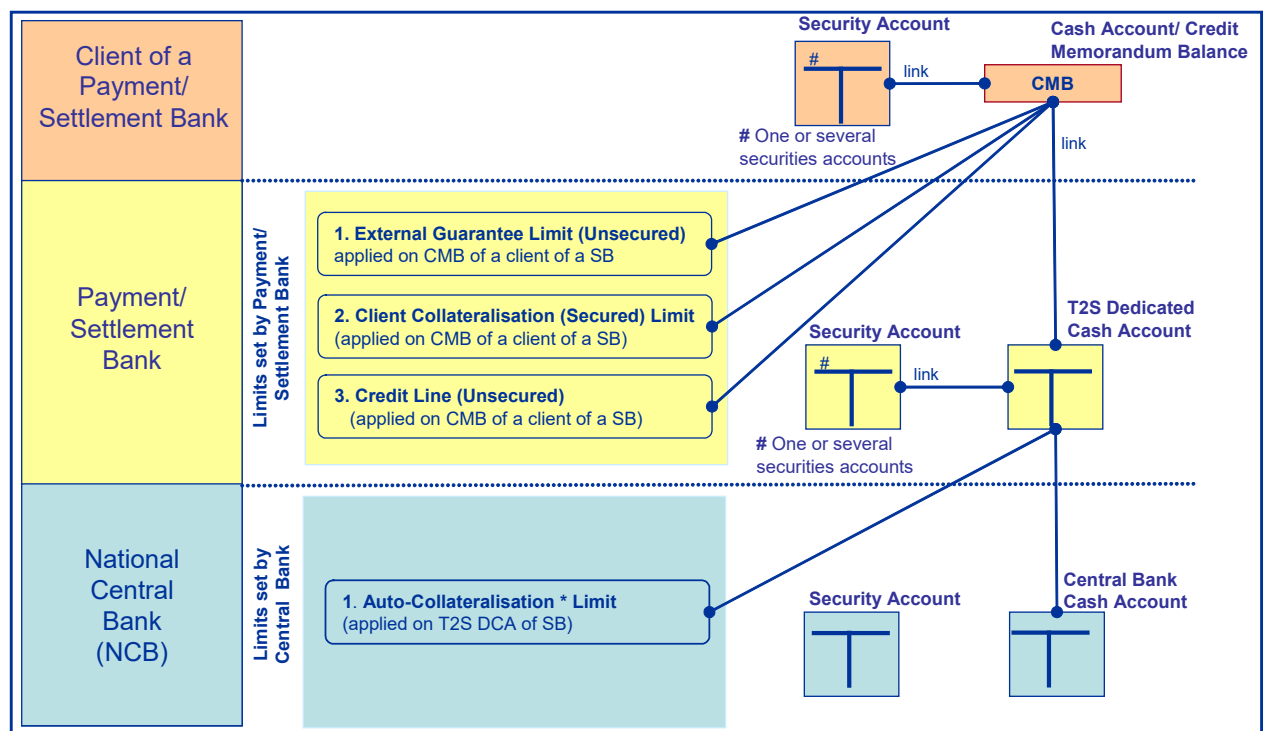

Central Banks and Payment Banks can set and monitor the limits they provide to their clients.

T2S Framework Agreement

Schedule 5 – T2S Service Description

- **External guarantee limit:** Cap on credit secured outside T2S that the Payment Bank sets for its client. The external guarantee limit and the unsecured credit limit are identical from the T2S viewpoint, except for the sequence in which they are triggered. Usage of the external guarantee limit is triggered before client-collateralisation.
- **Client-collateralisation limit:** Cap on the amount of credit extended against securities by a Payment Bank in T2S
- **Unsecured credit limit:** Cap on the amount of credit granted by a Payment Bank (generally unsecured outside T2S)
- **Auto-collateralisation limit:** Cap on the amount of credit extended against securities by a Central Bank to the Payment Bank.

T2S ensures that all the required provision checks for the Payment Banks and their clients are performed simultaneously and that collateralisation operations are initiated on the basis of the results of the provision check. A Payment Bank client's credit exposure as well as the availability of sufficient headroom on different types of credit limits is determined solely on the basis of information available to T2S.

To prepare for client collateralisation, the T2S Actor has to provide and to set up the information required for the link between its Security Account and its DCA, and to provide the necessary information for the Credit Memorandum Balance (CMB) Security Account Link Set and CMB Security Account Link⁷.

Furthermore, a T2S Actor can control the use of liquidity by reserving/ blocking cash for specific instructions. The amount of cash reserved/ blocked may not be used to settle instructions, unless the instruction being settled refers to the initial reservation/ blocking instruction.

5.3 T2S SD.LIM 030: End of day (EOD) cash management service

After the cut-off of settlement processing, the EOD processing is conducted in three steps. Information messages are sent to the initiating T2S Actor and other duly authorised T2S Actors in accordance with their message subscription preferences:

⁷ Further details can be found in the User Detailed Functional Specifications (UDFS), especially chapter 1.1.2 Liquidity management

T2S Framework Agreement

Schedule 5 – T2S Service Description

1. EOD release of unused cash restrictions:
 - All restrictions on cash (blocked cash, reserved cash) are released for the current Settlement Day.
 - New cash settlement restrictions regarding CoSD blocking are created for the next Settlement Day.
2. EOD release of auto-collateralised positions and transfer of cash balance:
 - The amount of outstanding auto-collateralisation is validated.
 - If there is no pending auto-collateralisation: No action is taken.
 - If there are pending auto-collateralisation(s):
 - and the cash on the T2S DCA is sufficient to reimburse fully the pending auto-collateralisation, including possible cash rebalancing: T2S reimburses.
 - and there is insufficient or no cash on the T2S DCA to reimburse the pending auto-collateralisation, T2S:
 - checks for available cash via cash rebalancing from another DCA of the same T2S Actor;
 - releases the associated reverse (unwind) settlement instructions previously created;
 - creates instructions for positions that will not be released (equivalent to the pending amount of auto-collateralisation that cannot be reimbursed out of T2S), to transfer the collateral to the Central Bank overnight collateral Security Accounts; and
 - rebalances the account to zero.
3. Optional EOD liquidity transfer (cash sweep)
 - Liquidity transfers are created for all T2S DCAs and the Central Bank Account used for EOD reimbursement with non-zero cash balances on an optional basis.
 - These liquidity transfers are settled in T2S and sent to the RTGS system.

5.4 T2S SD.LIM 040: Corporate action cash service

T2S enables a T2S Actor, receiving cash proceeds from corporate actions on its T2S DCA, to specify whether T2S should keep the cash proceeds on the T2S DCA or to retransfer them from the T2S DCA to the RTGS account (outside T2S) with which the T2S

T2S Framework Agreement

Schedule 5 – T2S Service Description

DCA is linked.

In such case, the T2S Actor must define a standing liquidity Transfer Order for the T2S DCA as part of the Common Reference Data to be able to opt for an automated retransfer of cash proceeds to an RTGS account.

T2S allows the T2S DCA holders to use different T2S DCAs for the settlement of the cash leg of trading-related instructions and for the settlement of the cash leg of corporate action instructions.

During both the daytime Real-time Settlement and night-time Batch Settlement T2S executes the standing liquidity Transfer Order as an immediate liquidity transfer to transfer the corporate action proceeds to the RTGS account of the T2S Actor.

For the countries using repos, T2S also provides this setup and service for retransferring monetary policy operations related cash proceeds from a T2S DCA to an RTGS account.

5.5 T2S SD.LIM 050: Cash blocking and reservation service

T2S allows a T2S Party to use restrictions to block or to reserve a cash balance in a T2S DCA. For that purpose, the CSD or the Central Bank has to define the relevant restriction types as part of the Common Reference Data.

Blocking a cash balance involves preventing the transfer of a specified amount of funds in a specific currency in one cash account to any other cash account by linking it to a specific purpose. Blocking in T2S never results in a negative cash balance, i.e. it is not possible to block an amount of funds greater than the available cash balance on a cash account.

Reserving a cash balance prevents the transfer of a specified amount of funds in a specific currency in one cash account to any other cash account except for the purpose for which the funds were reserved. The settlement of the underlying settlement instruction (for which the funds were reserved) results in the actual transfer of the reserved funds to another cash account and the subsequent removal of the reservation.

A T2S Actor may reserve a cash position without yet disposing of the required full amount of cash in that position. Any cash arriving in the reserved position will be attributed to the reservation until the required amount has been reached.

A T2S Actor may refer to an existing reservation/blocking in another settlement instruction, by referring to the unique reference number of the reservation's/blocking. Such reference will be interpreted in such a way that the provisioning process includes the reserved/blocked amount of cash in its provisioning check. The reserved/blocked cash

T2S Framework Agreement

Schedule 5 – T2S Service Description

will be used first (ahead of unreserved/unblocked cash) for settlement of the instruction.

During business validation, T2S checks automatically whether one of these restriction types applies to the submitted settlement instruction or to an instruction for an intra-position movement to determine the further processing required. If the validation process finds a match for a restriction type, then the relevant restriction type is applied to the instruction.

5.6 T2S SD.LIM 060: Liquidity monitoring service

T2S provides different functions for monitoring the actual cash balances of the DCAs as well as the CMB limits to monitor the liquidity of the clients of the Payment Bank. T2S calculates the amount of cash required for the settlement and informs the T2S Actor if more liquidity is needed.

Cash related queries allow duly authorised T2S Actors to obtain information about their account balance on the T2S DCA(s), outstanding intraday credit from auto-collateralisation, and potential liquidity based on securities on stock that can be used for auto collateralisation purposes. In addition, T2S provides information showing the overall liquidity.

A T2S Actor may request information on cash needs for instructions pending for settlement during the current Settlement Day, as well as cash forecasts for the following Settlement Day. Information on cash needs and cash forecasts covers T2S DCA liquidity needs.

Information for the on-going Settlement Day is intended to provide a snapshot of the cash required to settle instructions remaining unsettled at the moment of the snapshot. This information includes (as part of the cash required for the current day settlement) the value of potentially available auto-collateralisation.

Information on cash forecasts for the following Settlement Day and in particular for the following night-time settlement window is intended to allow T2S Actors to prepare and dedicate in advance sufficient cash for the settlement of their instructions during the following night-time settlement window. The cash forecasts are based on:

- cash needs resulting from the net balance between:
 - cash proceeds and
 - cash needsexpected for settlements with the following day as the ISD; and
- the amount of intraday credit that can be obtained through auto-collateralisation;

T2S Framework Agreement

Schedule 5 – T2S Service Description

- the amount of liquidity credit that can be obtained through external guaranteed limits and unsecured credit lines from Payment Banks or Central Banks.

Depending on the chosen report configuration, cash forecasts can be received as reports sent out automatically by T2S at certain points/when certain events occur during the Settlement Day. Preliminary information on cash can also be obtained via the query functionality.

However it should be noted, that these cash forecasts (received through the above-mentioned reports and via queries) are only indicative of the final cash needs, as the forecasts are based only on the information available in T2S: T2S does not take corporate action proceeds into account, if the relevant instructions are not submitted to T2S.

The T2S Actor has to be aware that these cash forecasts will change in the course of the Settlement Day depending on new settlement instructions / liquidity transfers submitted to T2S. It is to be expected that the quality of the cash forecast will increase continuously during the day as additional settlement instructions and information become available in T2S.

A T2S Actor is able to define the floor and ceiling amounts per DCA in the Common Reference Data. This functionality allows the T2S Actor to receive alerts if the amount of liquidity in the DCA reaches the minimum/maximum the DCA account holder has defined.

5.7 T2S SD.LIM 070: Multiple liquidity provider service

T2S DCA holders may receive liquidity from several RTGS accounts (i.e. from different liquidity providers) and use the proceeds in T2S. This cash can be transferred from the RTGS accounts prior to the start of Batch Settlement in T2S. Subsequently, a T2S DCA holder can use this cash for its own settlement purposes or to provide cash settlement services to its clients, during Batch Settlement in T2S.

At the end of the Batch Settlement, a T2S DCA holder may opt to establish liquidity transfers which will reimburse its different liquidity providers in the relevant RTGS systems with the remaining cash in the T2S DCA. This reimbursement facility is the “multiple liquidity provider” service.

The reimbursement of cash is executed via outbound liquidity transfers generated by T2S on the basis of the multiple “standing liquidity transfer order”. The priority of execution is defined by the T2S Actor in the “order link set” setup in the Common Reference Data.

T2S validates whether a T2S DCA holder (liquidity receiver) has opted for a “multiple liquidity provider” service for reimbursement. If this is the case, T2S reimburses the liquidity providers in the sequential order of liquidity providers as set up in the order link

T2S Framework Agreement
Schedule 5 – T2S Service Description

setup (in the Common Reference Data). T2S aims to reimburse each liquidity provider up to the maximum amount of the cash the liquidity provider transferred before starting to reimburse the next liquidity provider in the sequential order concerned. In the order link set, the main liquidity provider is setup as the last liquidity provider and therefore is the last liquidity provider to be reimbursed (assuming there is sufficient cash to reimburse all liquidity providers).

6 T2S SD-STD: Common Reference Data Management Service Class

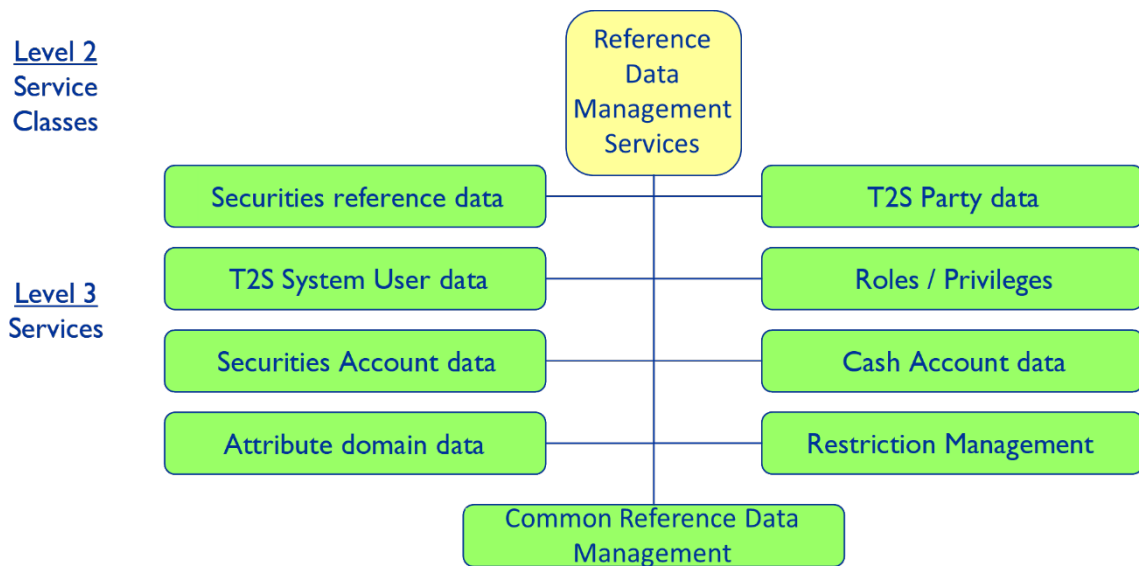

6.1 T2S SD.STD 010: Common Reference Data management service

Common Reference Data management is the service that T2S provides through the Common Reference Data Management (CRDM)⁸ component for setting up/inserting, changing/maintaining and inactivating/deleting Common Reference Data in T2S regardless of the type of conceptual entity. T2S applies the same functional principles for inserting, maintaining and deleting all entities.

T2S processes all Common Reference Data updates in real-time in both User-to-

⁸ Common Reference Data Management (CRDM) is a common component handling the reference data for multiple TARGET Services, including T2S.

T2S Framework Agreement

Schedule 5 – T2S Service Description

Application (U2A) and Application-to-Application (A2A) mode, except in the case of some preliminary functions which are only available in U2A mode⁹. All Common Reference Data entities are stored in the T2S data base with a full audit trail and it is possible to query the actual occurrence of an entity as well as the historical data. Whenever a record in Common Reference Data is changed, a new version of this record is stored including the timestamp and the identification of the T2S Actor performing the change, thereby maintaining a full audit trail.

T2S allows T2S Actors to parameterise the entities and the types of updates made by a T2S User or by a T2S process. In general, T2S will process these in real-time except during the Maintenance Window (see UDFS for further information). T2S checks for every change in a Common Reference Data entity and for the change approval configuration for this entity and processes the update in accordance with the configured parameters. The privileges of the different T2S Users depend on the Common Reference Data entity. Security reference data changes made by an automated interface do not require an independent change approval by a second user, but a manual update by a person is subject to such approval (4-eyes principle).

T2S provides duly authorised T2S User with the functionalities to:

- identify all reference and Dynamic Data changes awaiting approvals;
- search for specific reference and Dynamic Data changes;
- search and display historic change information, including both approved and rejected changes; and
- approve and reject reference and Dynamic Data changes.

6.1.1 T2S SD.STD 011: Insert service component

T2S allows the duly authorised T2S User to insert a new occurrence of an entity into Common Reference Data. A T2S User is an individual or application that is allowed to communicate with T2S when duly authorised and authenticated.

6.1.2 T2S SD.STD 012: Update service component

T2S allows duly authorised T2S User to update an existing occurrence of a Common Reference Data entity. T2S allow T2S Users to update occurrences of a Common Reference Data entity if the previous update of the same occurrence remains in the

⁹ The detailed list of available functions for the different modes are part of the UDFS and of the UHB.

T2S Framework Agreement

Schedule 5 – T2S Service Description

change approval queue. T2S prohibits the concurrent update of occurrences of a Common Reference Data entity. When a T2S User selects an occurrence for editing, T2S locks the occurrence so that a second T2S User or T2S process cannot access it for updating.

6.1.3 T2S SD.STD 013: Delete service component

When a duly authorised T2S User initiates the deletion of an occurrence in a Common Reference Data entity, T2S checks that there are no unsettled instructions and only zero positions pertaining to that data. Only if that is the case will the deletion status of the occurrence be changed from “active” to “deleted”. The deletion of an occurrence of a Common Reference Data entity occurs only logically.

The T2S archiving functionality is the only function which will physically delete an occurrence of a Common Reference Data entity from the active T2S database. The physical deletion of a Common Reference Data occurrence is only possible for logically deleted occurrences. To ensure the referential integrity of data, Common Reference Data occurrences are physically deleted from the active database only after archiving processes have removed and archived the related Transactional Data and position data as of a cut-off date that is determined by the retention plan. Data history and data revisions that took place before the archive date will be included in any physical deletion process even if the current record is still active - since the Transactional Data for which they are relevant would be removed by the archiving.

6.1.4 T2S SD.STD 014: Reactivate service component

In some instances, it is necessary to reactivate a logically deleted occurrence of Common Reference Data. T2S allows duly authorised T2S Users to specify the Common Reference Data entity and the identifier of an occurrence in that Common Reference Data entity, and to reset the deletion status of an occurrence in that Common Reference Data entity from “deleted” back to “active”.

6.2 T2S SD.STD 020: Securities Reference Data service

Securities Reference Data in T2S defines the set of entities and attributes that T2S requires for settlement and auto-collateralisation in CeBM, as well as the calculation of cash penalties.

The Securities Entity holds all attributes that exist only once for a security. Securities Reference Data require every security to have an ISIN code, compliant with ISO 3166. The creation of a new security will be effective immediately unless it requires dual entry approval. This also applies to updates of all attributes for the Securities Entity. Certain

T2S Framework Agreement

Schedule 5 – T2S Service Description

“non-standardised securities” that comply with all required criteria apart from not being fungible from a settlement perspective may still be entered in and processed by T2S.

The Securities Reference Data Service allows the CSD to create and maintain the Common Reference Data of those securities for which it is the Securities-Maintaining Entity. In addition, the non-SME CSDs may maintain Market-Specific Attributes on securities for their market. The service allows the Issuer CSD to block or unblock ISINs both for itself and its Investor CSDs. T2S allows an Investor CSD to block or unblock ISINs.

For the purposes of cash penalty calculation, the Securities Reference Data Service requires each SME CSD to provide the list of securities subject to cash penalties and the related daily prices, as well as a liquidity indicator for certain types of financial instruments; In addition to Securities Reference Data for which the SME CSD is responsible, other mandatory data related to the applicable penalty rates for cash and securities including a list of relevant trading venues is maintained by the T2S Operator, while the ECB is responsible for the input of the daily euro foreign exchange reference rates.

6.3 T2S SD.STD 030: T2S Party data service

T2S deploys a flexible hierarchical party model to allow CSDs and Central Banks to manage their accounts and parties in an efficient way. The T2S Operator maintains the first and second level of the hierarchy. All other levels must be managed by the CSDs and the Central Banks respectively.

A T2S Party denotes any legal or organisational entity required in T2S as single legal entity to guarantee data segregation. The same legal entity, or organisational unit of a legal entity, may be set-up under several CSDs or Central Banks as a result of this principle. This entity includes the parties from the first three levels of the hierarchy model, the T2S Operator, the CSDs, the participants of the CSD, the Central Banks and the Payment Banks. It also establishes the links between the different parties on the different hierarchical levels. A CSD can also be a T2S Actor for its own purposes defined in level 3 of the hierarchy as a CSD participant (see graph below).

T2S assigns each party a technical identifier, which the user can also use as the unique T2S Party code (participant code). T2S will use the BIC of a T2S Party to identify the T2S Party uniquely across in the Central Bank - and CSD-specific reference data.

T2S Framework Agreement

Schedule 5 – T2S Service Description

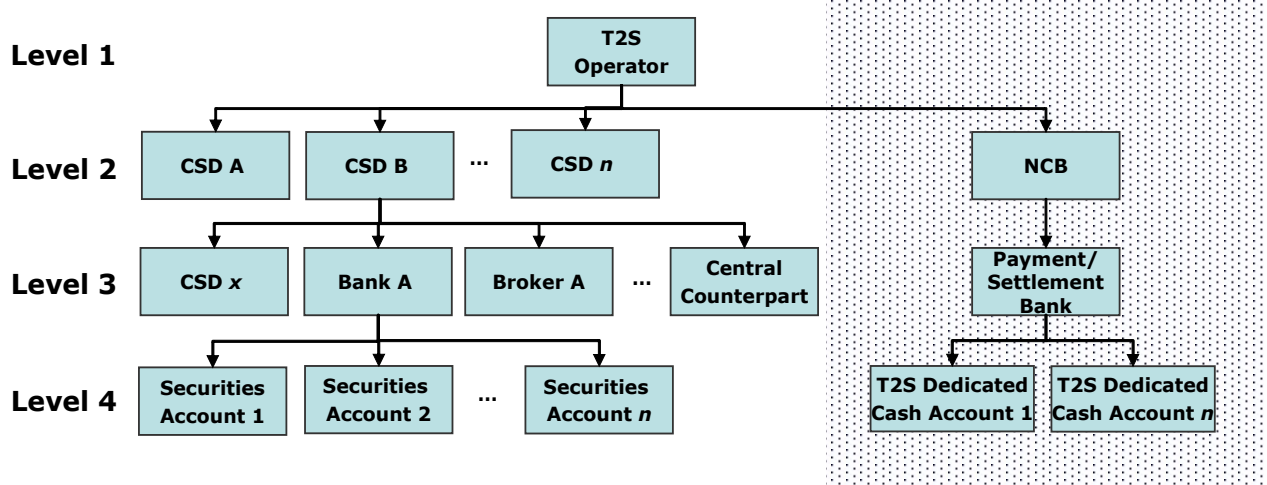

The CSD-part of this hierarchical structure contains all T2S Party data pertaining to securities settlement. The Security Account (on the lowest level of this part of the hierarchy) is assigned to the CSD participant and to the CSD. Some specific account types are assigned to level 2 parties, for example a Mirror account. Each CSD is responsible for maintaining the hierarchy including the Security Accounts of the different parties which are linked to it. CSDs assign and manage the access rights of their participants, including those of all their DCPs.

Security Accounts linked to the CSD participant and T2S DCAs linked to a Payment Bank form the lowest level of the hierarchy. The Security Accounts assigned to level 3 parties can for instance be omnibus accounts or DCAs. CSDs have access to Central Bank party and account Common Reference Data to link Security Accounts to T2S DCAs for the settlement of the cash leg of a settlement instruction. T2S will make available to the CSDs the relevant data for the linking of accounts without publishing all T2S DCAs. Access rights control which CSD is able to see the T2S DCAs needed for linking purpose. When a CSD sets up a Security Account, it can only see those T2S DCAs to which it can link a Security Account for settlement.

The Central Bank part of the hierarchical structure includes all data relating to the Central Bank and the T2S DCAs held with the Central Bank by Payment Banks. In the third tier of this part of the hierarchy includes the Payment Banks which operate T2S DCAs to provide liquidity. The T2S DCAs are the lowest level of the hierarchy. The hierarchy links the T2S DCA to the relevant euro area or non-euro area NCB.

Central Banks authorise the access to T2S DCAs by assigning the BIC of those parties, eligible for access to the cash account for settlement, to the T2S DCA. When entering a Security Account, the CSD only sees those T2S DCAs which have the same BIC assigned to them as the T2S Party that owns the Security Account.

T2S Framework Agreement

Schedule 5 – T2S Service Description

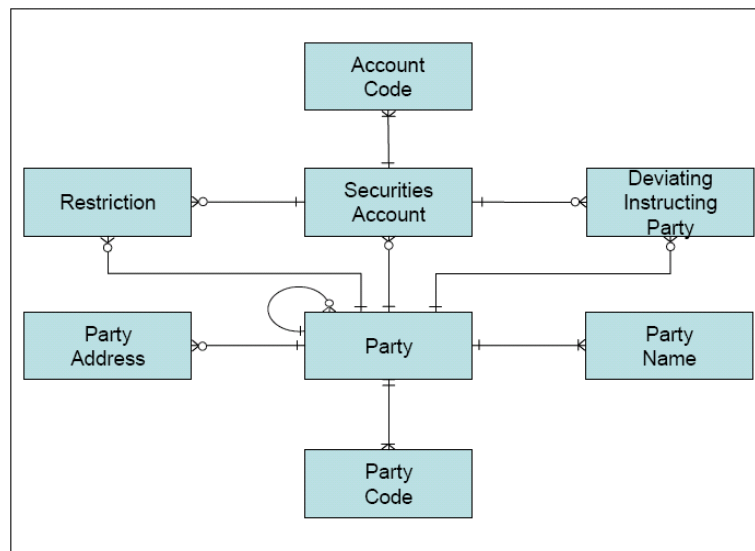

6.4 T2S SD.STD 040: Security Account data service

Security Account reference data specify all information required for defining and processing a Security Account in T2S.

Security Accounts in T2S must be opened and closed by the CSD to ensure the consistency and integrity of Security Account reference data between the CSD and T2S. When the CSD opens an account, it must immediately trigger the opening of the relevant account in T2S. The same applies for the closing of an account.

T2S supports a T2S Actor - Security Account Relationship entity to specify a time-dependent relationship between a T2S Actor and a Security Account. The purpose of the entity is to allow a CSD in T2S to transfer a Security Account relationship from one account operator/sub-custodian to another account operator/sub-custodian within the CSD. The functionality enables a CSD to transfer an end-investor Security Account relationship from one account operator to another.

CSDs are also responsible for closing a T2S Security Account by setting the business status to “closed” and confirming the change. T2S only closes an account if:

- there is no un-settled instruction specifying the T2S Security Account for the settlement;
- the T2S Security Account is not part of an active T2S link set; and
- there is no securities balance remaining on the T2S Security Account.

In case an unmatched instruction exists concerning an account that is closed, during the business revalidation the unmatched instruction is identified and will be cancelled.

6.5 T2S SD.STD 050: Cash account data service

The T2S DCA model specifies the requirements for assigning T2S DCA to Security Accounts for the settlement of the cash leg of settlement instructions. The T2S DCA entity specifies the T2S DCAs of Payment Banks in T2S. It also links the T2S DCA to the associated RTGS account concerned as well as establishing the reference link to the Payment Bank that owns the account and to the Central Bank that operates the account.

The key responsibilities of each Central Bank whose currency (euro and non-euro) is available for settlement in T2S are:

- set-up and maintain the DCAs of their RTGS participants for all securities-related payment transactions in their currency in T2S;
- set up and manage Common Reference Data, access rights and configuration data pertaining to its members and its own participation in T2S;
- if required, provide for the interoperability of their own RTGS systems and collateral management systems with T2S;
- if the Central Bank chooses to participate in auto-collateralisation:
 - to provide auto-collateralisation in its currency to its members in accordance with its self-defined eligibility criteria;
 - if required, to provide to T2S, for the specific purpose of auto-collateralisation, a list of eligible securities and prices as well as any other data necessary for T2S to judge the eligibility of a specific security for a specific participant;
- be responsible for the choice of its network provider(s) and to make every effort to maintain properly functioning connectivity to T2S functions properly.

Central Banks are also responsible for closing a T2S DCA by setting the business status to “closed” and confirming the change. T2S only closes an account if:

- there is no unsettled instruction specifying the T2S DCA for the settlement of the cash leg;
- the T2S DCA is not part of an active T2S DCA link set; and
- there is no cash balance remaining on the T2S DCA.

T2S Framework Agreement

Schedule 5 – T2S Service Description

Each T2S DCA may be linked to a T2 Main Cash Account (MCA)¹⁰ or to an External RTGS Account referring to a Cash Account in a separate RTGS system. The external RTGS Account Entity specifies all the external RTGS payment accounts to which an authorised T2S User can link a T2S DCA. This entity also provides the reference link to the Payment Bank that owns the account and the Central Bank that operates the account.

Where a link to an external RTGS system is required, the Central Banks have to add a new external RTGS account for a Payment Bank or another Central Bank in T2S. T2S assigns new external RTGS accounts an opened business status and the current Settlement Day as the opening date.

An external RTGS account can be closed by setting the business status to “closed” and confirming the change. T2S will not close an account if:

- there is an unsettled payment instruction specifying the external RTGS account;
- the external RTGS account has an active link to a T2S DCA; or
- the external RTGS account is defined in a current (not closed, not expired) standing liquidity transfer order.

T2S allows the blocking/unblocking of an external RTGS account using T2S Actor and account settlement restrictions. The blocking of an external RTGS account results in all T2S DCA linked to the external RTGS account being blocking from settlement.

6.6 T2S SD.STD 060: T2S User data service

A T2S User is an individual or application that is allowed to communicate with T2S using a login name and certificate/smartcard and for U2A in addition an optional password and/or certificate for authentication. The assignment of the T2S User to a T2S Actor establishes the relationship between the T2S User and the system entity. T2S provides specific roles and privileges to restrict the access of this T2S User to business data of the CSDs and of the Central Banks.

T2S User maintenance defines the process of adding, changing and deleting users in T2S. Access to this functionality is restricted to system administrators only.

A system administrator is able to lock and unlock a T2S User without deleting the user by

¹⁰ A Main Cash Account (MCA) is another type of cash account used for settlement of operations with central banks (please refer to Article 1(a) of the Guideline ECB/2022/8) in T2, handled within the Common Reference Data Management component, outside of the T2S scope.

T2S Framework Agreement

Schedule 5 – T2S Service Description

setting the attribute "lockout status" to "yes" or "no". If the system administrator assigns existing roles to or deactivates roles for a T2S User, T2S automatically assigns to the T2S User the privileges associated with that role.

6.7 T2S SD.STD 070: Roles and privileges data service

In order to comply with the principle concerning the separation of functions and roles, T2S implements roles and privileges as business concepts which refer to the right of T2S Actors to interact with T2S. Duly authorised system administrators configure roles and privileges to authorise other T2S Users to execute specific functions or view specific data.

A privilege is a right, either granted or denied, to execute certain functions within T2S, or to access and/or update certain data in T2S. It is through the privileges that access to functionality and data for specific roles is granted and restricted to T2S Actors. A privilege is uniquely identifiable, both internally in the application and to the T2S system administrator. Privileges are classified either as System privileges or Object privileges.

System privileges grant certain rights for a single or a homogeneous group of data objects . Object privileges grant rights in relation to a single or a group of Common Reference Data objects.

The administrator grants a privilege by specifying whether (1) the associated functionality is allowed or explicitly denied; (2) the grantee of the privilege is allowed to grant the same privilege to another user or role; (3) the grantee of the privilege is allowed to use the function associated to the privilege in accordance with the two-eye- or four-eye-principles.

Account owners (i.e. a CSD or a Central Bank) may grant privileges to their clients, with different roles and privileges for each one. These roles and privileges can be differentiated by client and even among different accounts of the same client.

T2S privileges may for example grant:

- no access at all;
- read only access;
- the right to instruct with possible limitations concerning the type of instructions or the accounts to instruct on.

A role consists of one or more privileges. A CSD or a Central Bank may configure valid roles for its T2S parties as follows:

- If set up by the CSD, DCPs manage their T2S User administration.
- If set up by the Central Bank, Payment Banks manage their T2S User

T2S Framework Agreement

Schedule 5 – T2S Service Description

administration.

Each CSD or a Central Bank needs to create and authorise a system administrator for each of its client T2S Actor of that CSD or of that Central Bank. The system administrator is responsible for maintaining users and roles for this particular client. The CSD or Central Bank administrator has to ensure, that the system administrator of the T2S Party has access only to those roles that the CSD or Central Bank permits. Accordingly, T2S enables each CSD or the Central Bank to grant its clients access to a different set of roles, depending on the services provided by the CSD or the Central Bank to each T2S Party.

CSDs or Central Bank participating in T2S must continue to comply with Legal and Regulatory Requirements. T2S therefore allows the configuration of CSD- or Central Bank - specific roles. The CSDs or Central Bank may differentiate the access they grant to T2S Services and functions on the basis of the Legal and Regulatory Requirements to which they are subject.

6.8 T2S SD.STD 080: Restriction management service

T2S must support the T2S Operator, CSDs and Central Bank by enabling them to provide specific validations and processing of settlement instructions to fulfil the Legal and Regulatory Requirements and the supervisory requirements in the markets that they service. T2S therefore allows the T2S Operator, CSDs and Central Banks to define their own restriction types.

Restriction types are attributes that define the specific processing characteristics for a securities position, cash balance, Security Account, T2S DCA, T2S Party or settlement instruction to ensure configurability of specific requirements, as prescribed by national Legal and Regulatory Requirements and practices, and to avoid hard-coding in the application software.

T2S provides the following restriction processing types:

- Blocking – blocks an instruction from settlement;
- Rejection – rejects an instruction at validation;

T2S Framework Agreement

Schedule 5 – T2S Service Description

- CSD Validation Hold – accepts a settlement instruction at validation (not applicable to settlement restrictions) but holds it for a subsequent release by the CSD¹¹;
- Reservation – reserve a cash balance or securities position;
- Balance Type / Earmarking – define and manage position types for securities and balance types for cash balances.

Restrictions can also be defined as either a positive or negative parameter set and in time (from and to).

During the validation process, T2S automatically verifies whether one of the defined restrictions applies to the instruction submitted.

A T2S User may define specific rules for restriction types. These define the sequence in which T2S applies a logical set of parameters to determine whether a specific restriction applies to the instruction. The restriction matrix defines the specific parameter values within a rule. T2S stores matrix entries for a rule in a rule set. A matrix entry defines an occurrence of a valid set of values, specifying the actual criteria against which T2S must validate a settlement instruction to determine whether a restriction type applies.

T2S allows duly authorised users to

- add new rules for a restriction type;
- (re-) define the sequence of rules for a restriction type;
- delete rules for a restriction type if the user has deleted all occurrences under that rule; and
- add and delete matrices in a rule.

This functionality is also used by CSDs to define which settlement instructions will be put on CSD Validation Hold. It allows CSDs to execute certain tasks / validations locally prior to the settlement of the underlying instruction.

¹¹ Further details for the CSD validation hold are provided in the User Detailed Functional Specifications (UDFS) chapter 1.1.1 Settlement

6.9 T2S SD.STD 090: Attribute domain data service (market-specific attributes)

Attribute domains in T2S provide the valid list of values allowed for an attribute (table column or a data field in physical terms). They include a list of all the valid values that a user can enter for an attribute of a reference or Transactional Data entity. T2S uses attribute domains for field validations and for documenting the business definition of a value in an attribute.

Through the Common Reference Data Management component, T2S Common Reference Data allows the duly authorised T2S User to logically create, modify and deactivate market-specific attribute domains, on the basis of the existing data definitions (attributes). These market-specific attribute domains allow the T2S Operator, CSDs and Central Banks to define their own restriction types as described above. T2S allows the definition of additional values, mapped to an attribute.

T2S limits the actions that a user can trigger in the database using attribute domain management. T2S allows the registration and deactivation of attribute domains using pre-defined database tables.

7 T2S SD. INF: Information Management Service Class

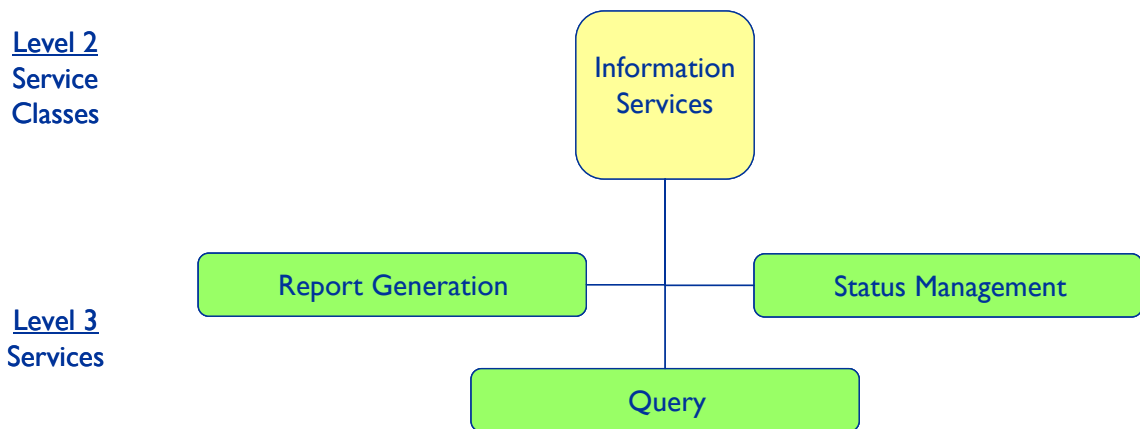

7.1 T2S SD.INF 010: Status management services

As part of its settlement services, T2S maintains the settlement statuses of any instruction it processes. T2S informs duly authorised T2S Actors of the result of all settlement services and of all changes to the statuses of instructions, depending on the message subscription chosen by the T2S Actor.

T2S provides multiple-statuses reporting that gives more flexibility and brings more efficiency than single-status reporting. In this context, T2S provides the values of the different statuses for each instruction in a report or query response. Status messages report the status that has changed.

If instructions are rejected, settlement attempts unsuccessful or instructions cancelled, T2S also informs the relevant T2S Actor why this has happened.

7.2 T2S SD.INF 020: Report generation service

T2S interface and Common Components business interfaces provide a defined set of reports. Reports are triggered automatically by T2S. All reports are available in both User-to-Application (U2A) and in Application-to-Application (A2A) mode as in the T2S Connectivity Services description. These reports are not, and should not, be considered as regulatory reports. T2S Actors may use the query services described hereafter to receive the necessary information from T2S to provide their regulators with the required information.

T2S reports are either event-triggered or sent at a fixed time. When a CSD, T2S Actor or Central Bank require information at a time not so triggered, the information can also be retrieved using the query service.

Reports containing information either on individual accounts or on a set of accounts can

T2S Framework Agreement

Schedule 5 – T2S Service Description

be sent to the relevant CSDs and DCPs, or to the relevant Central Bank. T2S reports are based on the latest available data and contain a date and time stamp. In addition, T2S sends successive versions of defined reports with the information that changed from the previous version to the next version of that report (delta reporting). The additional information includes the attributes of the reported items as provided in the previous version of the report.

A DCP may receive reports only on:

- its own securities and cash balances, those of its clients and those of any other T2S Actor for which the appropriate authorisation was granted;
- instructions that were submitted by the T2S Actor (or a Third Party with access rights - supported by power of attorney to do so on behalf of the T2S Actor) and instructions that refer to the securities or cash account of the T2S Actor (or any sub-account thereof);
- cash penalties (and their aggregated monthly amounts) that are either charged or credited to the DCP; and
- its own Common Reference Data, as well as some generic Common Reference Data on instruments and the daily Schedule.

A CSD may receive reports only on:

- instructions that were submitted by the CSD in T2S itself, its DCPs, or by its participants;
- securities transactions and balances of the CSDs own accounts in T2S, those of its DCPs and those of its participants;
- cash penalties (and their aggregated monthly amounts) that are either charged or credited to itself or to its participants; and
- Common Reference Data of the CSD in T2S itself, its DCPs, and of its participants, where privileges permit. These Common Reference Data include those ISINs for which the CSD acts as Security Maintaining Entity (SME)¹². Additionally, a CSD may query all Common Reference Data that relate to its admission rule, for securities as well as for parties.

¹² Further details can be found in the Manual of Operational Procedures (MOP)

T2S Framework Agreement

Schedule 5 – T2S Service Description

A Central Bank may receive reports only on:

- instructions that were submitted by the Central Bank in T2S itself, or by its Payment Banks;
- cash balances of its own DCAs in T2S and those of its Payment Banks as well as cash movements on its own DCAs and those of its Payment Banks; and
- Common Reference Data of the Central Bank in T2S itself, and of its Payment Banks. Additionally, a Central Bank may query all Common Reference Data that relate to its national currency.

A Payment Bank may receive reports only on:

- instructions that were submitted by itself;
- cash balances of its own DCAs in T2S; and
- its own Common Reference Data, and that pertaining to its DCAs.

T2S provides the following report types (non-exhaustive, a full list can be found in the UDFS):

- Statements of holdings;
- Transaction reports:
 - Statement of transactions;
 - Statement of pending instructions;
 - Statement of settlement alleggements;
 - Statement of Security Accounts at EOD;
 - Statement of changes to Common Reference Data; and
 - Billing data report.

T2S Framework Agreement

Schedule 5 – T2S Service Description

- Cash forecast reports:
 - Current Settlement Day cash information; and
 - Following Settlement Day cash forecast.
- Cash Penalties reports:
 - Daily Penalty List;
 - List of Modified Penalties; and
 - Monthly Aggregated Amounts of cash penalties.

7.3 T2S SD.INF 030: Query service

T2S allows information to be queried in T2S and in Common Components. Queries are triggered by the duly authorised T2S Actor. All queries are available in User-to-Application (U2A) (except Liquidity Information Query) and a subset is available in Application-to-Application (A2A) mode (e.g. exception: Liquidity Information Query is only available in A2A mode, see UDFS for further detail). All securities instructions, and balances and Common Reference Data queries are available for all CSDs in T2S, DCPs as well as Central Banks and Payment Banks, in accordance with to the access rights.

Additionally, cash penalties queries in User-to-Application (U2A) are available for all CSDs in T2S, in accordance with the defined access rights.

T2S accepts all queries at any point in time during T2S opening days. T2S processes all queries in real time, on the basis of the latest available data. During the night-time settlement sequences, T2S queues balance queries sent in Application-to-Application mode while the U2A balance queries will not be processed. T2S responds to the A2A queries at the end of each sequence inside a cycle with the latest position.

T2S provides standard queries which can be taken as the basis (blueprint) for individual, non-standard queries. For individual, non-standard queries, T2S provides the option of specifying parameters in the query to fulfil the needs of the querying T2S Actor. When processing queries, T2S takes into account all access rights as defined in the Common Reference Data. T2S will only return results where the T2S Actor that has submitted the query has the right to access the underlying data. CSD/ Central Bank and T2S Parties may act as service providers for indirect Parties or e.g. remote brokers.

7.3.1 T2S SD.INF 031: Query service for T2S Actor service component

A T2S Actor may query the following – subject to access rights:

- its own securities positions;

T2S Framework Agreement

Schedule 5 – T2S Service Description

- instructions submitted by the T2S Actor itself (in case of direct connectivity), or by the counterparties (Allegements), or by a Third Party that has access rights in T2S supported by a power of attorney; and
- its own Common Reference Data, as well as some generic Common Reference Data relating to e.g. instruments and the daily Schedule.

7.3.2 T2S SD.INF 032: Query service for CSDs service component

A CSD in T2S may query the following:

- instructions that were submitted by the CSD itself, or by its DCPs;
- securities and cash balances of DCA(s) of the CSD itself and of its T2S parties in T2S;
- cash penalties (and their aggregated monthly amounts) that are either charged or credited to itself or to its participants;
- Common Reference Data of the CSD itself, and of its T2S Actors;
- Common Reference Data pertaining to securities.

7.3.3 T2S SD.INF 033: Query service for Central Banks service component

A Central Bank in T2S (acting in its role as euro area or as non-euro area NCB) may query:

- cash balances of the DCAs kept at the Central Bank in question;
- movements on the DCAs kept at this Central Bank; and
- Common Reference Data pertaining to the DCAs for which it is responsible.

Additionally, a Central Bank may act as a T2S Actor of a CSD. In this case, the Central Bank has the same access rights as any other T2S Actor. Finally, if a Central Bank plays the role of a CSD, that Central Bank, when doing so it has the same access rights of a CSD.

7.3.4 T2S SD.INF 034: Query service for Payment Banks (liquidity providers) service component

A Payment Bank in T2S (acting in its role as liquidity provider) may query:

- cash balances of its DCAs; and
- Common Reference Data pertaining to the DCAs for which it is responsible.

7.3.5 T2S SD.INF 035: Settlement-related queries service component

During the night-time settlement cycles, T2S stores balance queries sent in Application-

T2S Framework Agreement

Schedule 5 – T2S Service Description

to-Application (A2A) mode, then replies with a message that T2S is currently running a cycle and that T2S will respond to the query at the end of the cycle with the latest position.

T2S provides different standard queries related to settlement:

- Securities balance query:
 - The Securities Balance Query returns an account view on the position at a particular point in time, the latest securities position or at the close of settlement if requested after close of settlement, all positions are summarised in the account structure that is compatible with the query parameters.
 - The Securities Balance History Query returns all positions that occurred during a particular time period, all positions are summarised in the account structure that is compatible with the query parameters.
- Settlement instruction query:
 - T2S allows T2S Actors to query settlement instructions in accordance with the Actor's roles and privileges.
 - T2S provides a settlement instruction status audit trail query which allows a T2S Actor to query settlement instructions on the basis of the business processing status or a combination of business processing statuses on a specific date or in a specific period in the past

7.3.6 T2S SD.INF 036: Cash balance-related queries service component

In accordance with their access rights, Central Banks and settlement/ Payment Banks may query:

- the current balance of one or more T2S DCAs;
- the total current collateral value of securities earmarked and available (on stock) for auto-collateralisation for a T2S DCA. The collateral value of securities, calculated by the query, does not include securities on flow, as the settlement process will use these automatically;
- for a specific T2S DCA, the current total collateral value of every security, earmarked and available (on stock) for auto-collateralisation, in all Security Accounts, linked to the T2S DCA for settlement of the cash leg. The collateral value of securities, calculated by the query, does not include securities on flow, as the settlement process will use these automatically;
- the amount of outstanding intraday credit stemming from auto-collateralisation, defined as the difference between the credit utilised and the credit reimbursed;

T2S Framework Agreement

Schedule 5 – T2S Service Description

- for a specific T2S DCA, the collateral (amounts and securities) utilised for outstanding intraday credit stemming from auto-collateralisation;
- the total collateral (amounts and securities) utilised for outstanding intraday credit stemming from auto-collateralisation.
- In addition to the queries described above, T2S provides some screens in the T2S Interface (U2A mode) which give a consolidated view of the balances available on the different DCAs of each Payment Bank to facilitate the liquidity management of the treasurer(s) at the Payment Bank itself. These screens are available to directly connected Payment Banks and their Central Bank (further detailed in the User Handbook and the documentation on the GUI interface).
- In order to manage the liquidity of their DCAs, Central Banks and their Settlement/Payment Banks may also query:
 - limits and their utilisation,
 - liquidity Transfer Orders, and
 - liquidity Transfer Orders for multiple liquidity providers.

A CSD in T2S may query the cash balances of its own DCA(s) and those of its T2S parties in T2S.

7.3.7 T2S SD.INF 037: Common Reference Data-related queries service component

Common Reference Data queries are related to all main entities in Common Reference Data. CSDs and CSDs' participants may query Common Reference Data in accordance with their access rights.

T2S also provides a Common Reference Data audit trail query which allows a T2S Actor (in accordance with its access rights) to query all revisions to an occurrence of Common Reference Data.

Standard Common Reference Data queries allow the T2S Actor to query, in accordance with its access rights:

- Security reference data
- T2S Actor reference data
- Security Account reference data
- T2S DCA reference data
- T2S calendar and diary/daily Schedule
- T2S entities

T2S Framework Agreement

Schedule 5 – T2S Service Description

- Attribute domains
- T2S Actors, roles and privileges
- Restrictions
- Currency reference data

8 T2S SD. CON: Connectivity / Communication Service Class

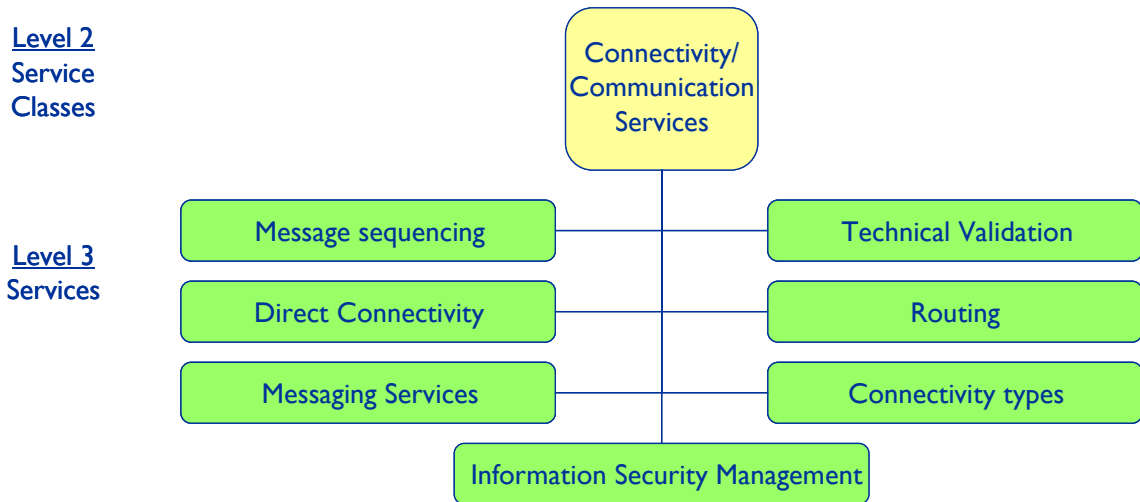

T2S does not provide technical connectivity/network services between the T2S Actors and T2S among its services. Network services have to be procured by the T2S Actors directly from one or more of the accredited Network Service Providers (NSP). T2S defines the technical and operational requirements for the NSPs¹³.

NSPs offer a catalogue of services with appropriate solutions for high settlement volume and small settlement volume T2S Actors. The Connectivity Service catalogue contains the connectivity to T2S service NSPs provide and the additional services offered by these NSPs, including;

- detailed services;
- Service Levels, detailing performances, availability and support commitments;
- volume related services;
- dedicated connectivity solutions; and
- backup/ alternative network access solutions.

¹³ The T2S Connectivity Guide provides further details on the different roles and responsibilities regarding the Connectivity Services

T2S Framework Agreement

Schedule 5 – T2S Service Description

8.1 T2S SD.CON 010: Messaging services

T2S provides standard, time-event-driven and business-event driven messages based on and compliant to the largest extent possible with the ISO 20022 / UNIFI (Unified Financial Industry Message Scheme) standard through the common Eurosystem Market Infrastructure Gateway component (ESMIG)¹⁴. Communication between T2S Actors and T2S has to comply with the formats and specifications defined in T2S and ESMIG. T2S supports push and pull mode for files and single messages in Application-to Application mode (A2A), as well as a Graphical User Interface (GUI) in User-to-Application mode (U2A).

In T2S “business terms” a message is a single instruction (e.g. a settlement instruction, matched or unmatched, a Common Reference Data maintenance instruction, etc) and in “technical terms” an XML string that refers to one or more “business messages”.

In T2S “business terms” a file is a set of instructions (more than one) and in “technical terms” a XML string that refers to one or more “business messages”, possibly of different types. Its size should be within a defined range (minimum and maximum considering performance aspects).

For each message or file received by T2S an acknowledgement is sent to the sending T2S Actor. An acknowledgement from the receiving T2S Actor is also expected for each message or file T2S sends out. Security-settlement-related and cash-management-related messages follow the same logic.

Inbound and outbound traffic is stored in T2S in original format messages (before any transformation) and the messages are kept with time-stamping information and signature.

8.1.1 T2S SD.CON 011: Push messaging service component

During the Real-time Settlement T2S sends real-time standard messages to the T2S Actors which are triggered by the relevant business events. These events for the generation and subsequent sending of the different messages are described in the corresponding chapters of this Service Description.

T2S applies automatic bundling of messages into files during night-time settlement, while offering the possibility for each Party to opt for the bundling of outbound messages into files during the whole business day. Exceptions during the business day are the

¹⁴ ESMIG is a common component acting as a technical gateway for the access to multiple TARGET Services, including T2S.

T2S Framework Agreement

Schedule 5 – T2S Service Description

Maintenance Window where no messages are sent and the period close to the DVP cut off . During this time the file bundling is deactivated and outbound messages are sent in real time.

After each cycle of the Batch Settlement T2S sends settlement related messages to the T2S Actors. For a given instruction only the most recent valid statuses will be sent. Settlement-related messages resulting from a night-time settlement sequence are bundled into a NTS file.

Copies are available for a subset of messages and can be received upon subscription by the relevant interested parties (a full list can be found in the UDFS).

T2S message subscription is a service that allows a CSD or another duly authorised T2S Actor with direct connectivity to T2S to subscribe to copies of messages sent between a Directly Connected Party (DCP) and T2S in real-time using push mode messaging.

The T2S Actor must define in Common Reference Data message subscriptions for all messages they want to receive. T2S only sends those messages the T2S Actor has subscribed to, there are no mandatory messages apart from the technical acknowledgements, query responses and inbound processing errors (a full list can be found in the UDFS), which are always delivered to the sender of the message. All messages, which are used by T2S, are available for message subscription. T2S will not send any message not subscribed to beforehand, although T2S generates all messages in accordance with the business context.

Subscriptions are based on one or more of the following parameters:

- Message type
- Instruction type
- Message Status
- Instruction status
- Party
- Securities Account
- T2S Dedicated Cash Account
- ISIN
- Transaction Code
- Currency
- Already matched flag

T2S Framework Agreement

Schedule 5 – T2S Service Description

- Settlement Transaction Condition Code
- Business Sending Party
- System User Reference
- Instructing Party
- Instruction Status Reason Code

For Central Banks, the messaging service includes i.a.:

- messages for each utilisation of intra-day credit stemming from auto-collateralisation; and
- messages for each repayment of intra-day credit stemming from auto-collateralisation.

The message subscription rules are defined and maintained in the Common Reference Data by the T2S Actor.

8.1.2 T2S SD.CON 012: Pull messaging service component

T2S Actors may request to receive specific messages from T2S. T2S uses this mode mainly for query services and reports. Additionally, through the Graphical User Interface (GUI) the T2S Actor may pull queries and reports.

8.2 T2S SD.CON 020: Technical validation services

T2S verifies that all inbound communication (messages and files) is compliant with T2S required syntax, format and structure. The message and file integrity check is part of the validation and ensures that only messages and files from T2S Parties enter the T2S applications. T2S validates files using the same standard as for the messages and ensures that inbound files are not lost, that outbound files are neither lost nor duplicated and that the recommendations of the Giovannini file transfer rulebook are applied (generic rules for file construction and best practices for file transfer operations for any and all file transfers, on any network).

If there are structure problems in a received message, T2S rejects the message. If there are file transfer or structure problems inside the file, T2S rejects the file in its entirety. If there are validation problems at the level of individual instructions within the file, the file is normally processed and a rejection message is sent for each individual invalid instruction the file contains.

T2S verifies whether the communication was received from a secured and recognised technical address configured in the Common Reference Data.

T2S Framework Agreement

Schedule 5 – T2S Service Description

8.3 T2S SD.CON 030: Connectivity types services

8.3.1 T2S SD.CON 031: Application to Application (A2A) service component

Application to Application (A2A) mode in T2S is a connectivity mode to exchange information between the T2S software application and application at the T2S Actor. In T2S, A2A can be based on either XML messages or file transfer. The ISO 20022 standard is applied as far as possible, for both inbound and outbound communication.

8.3.2 T2S SD.CON 032: User to Application (U2A) service component

By using the ESMIG Portal, the duly authorised T2S User can communicate with T2S via a web based Graphical User Interface (GUI), a connectivity mode to exchange information between software application of T2S and a T2S Actor and which is the User-to-Application interface (U2A) for interaction with T2S. The roles and privileges assigned to a T2S User determine which functions this user may execute and which data this user is allowed to see and to maintain.

8.4 T2S SD.CON 040: Information Security management services

Information Security management services are a crucial part of the total package of T2S Services, in terms of confidentiality, integrity and availability as well as authentication, accountability, non-repudiation and reliability of the T2S information.

Confidentiality or non-disclosure agreements between T2S and the T2S Actors address the requirement to protect Confidential Information using legally enforceable terms. Any access to the service's information by external parties must be controlled. Where there is a business need for working with external parties that may require access to the service's information, or when a product or service is obtained from or supplied to an external party, a risk assessment is carried out to determine Information Security implications and control requirements.

Access by external parties to the service's information is not provided until the controls have been implemented and, where feasible, a contract has been signed defining the terms and conditions for the connection or access and the working arrangement.

8.4.1 T2S SD.CON 041: Authentication service component

Authentication is a security mechanism which verifies the identity of an individual T2S Actor (the T2S User) or application trying to connect to T2S. A T2S User is an individual or application that is allowed to communicate with T2S using a login name and certificate/smartcard and for U2A in addition an optional password and/or certificate for authentication.

T2S Framework Agreement

Schedule 5 – T2S Service Description

T2S supports different types of authentication:

- Simple authentication requires to the T2S User to enter the T2S User ID and the respective password only. This is applicable only for U2A.
- Simple Certificate authentication requires the T2S User to use a certificate without entering a password in T2S. This is applicable only for A2A.
- Advanced Certificate authentication requires the T2S User to use a certificate in addition to entering the T2S User ID and respective password in T2S. This is applicable for U2A only.
- Smartcard authentication requires the T2S User to identify himself to the system using a smartcard in addition to entering the T2S User ID and respective password.

T2S stores and manages certificates as part of the Common Reference Data. For every inbound communication T2S verifies:

- the identification of the sender;
- whether the digital signature of the inbound communication corresponds to the certificate of the sender;
- the T2S Actor technical address;
- the network service used for the communication; and
- if the sender information of the inbound communication is defined in the Common Reference Data.

8.4.2 T2S SD.CON 042: Authorisation service component

Authorisation is a security mechanism which verifies that a T2S User or application (trying to connect to T2S) has the appropriate privilege to access certain functions or data within T2S. Authorisation is managed via the roles and privileges assigned by the T2S system administrators.

Initially the CSDs and the Central Banks (with respect to the Payment Banks) grant and manage the authorisation. Within a DCP or a Payment Bank, a system administrator may grant additional authorisations which are limited by the authorisation granted to the T2S Actor by the CSD or Central Bank.

T2S verifies the authorisation for every service and data access requested by a T2S User.

8.4.3 T2S SD.CON 043: 4-eyes principle service component

T2S ensures that any T2S operation to be executed in 4-eyes-mode is confirmed by a

T2S Framework Agreement

Schedule 5 – T2S Service Description

second authorised T2S User. The 4-eyes principle is only possible for U2A communication.

When a T2S User changes any occurrence of Static or Dynamic Data, which is subject to independent approval, T2S creates the changed version of the data as a new occurrence in the relevant revision entity and accords it a status "awaiting approval". The current version remains unchanged and is used until an independent source approves the update. If the independent approver accepts the change, T2S accepts the update and gives it the status "approved" in the Common Reference Data entity. T2S retains the previous version of the data from the current entity as part of the audit trail in the revision history.

If the update is not approved, T2S updates the status of the change to "rejected" and it remains as an unapproved change in the revision history.

8.5 T2S SD.CON 050: Message sequencing services

T2S assigns each outgoing message a business sequence number which allows all T2S Actors to identify the sequence of messages T2S has sent. The receiving T2S Actors can thus identify whether messages are missing or misplaced in the sequence.

This service is used for all business related messages sent out by T2S.

8.6 T2S SD.CON 060: Direct Connectivity Services

Direct (technical) connectivity is a technical facility which allows T2S Actors to access T2S and use its services without using the relevant CSD/ Central Bank as a relay or proxy. Direct connectivity affects neither the business or legal relationships between CSD and T2S Actor, nor the processing of the instructions of the CSD's or Central Bank's T2S Actor.

Direct connectivity is a technical concept and means the existence of a (direct) network connection between a T2S Actor and T2S, though a Network Service Provider. It does not mean that the T2S Actors concerned has any particular roles or privileges.

DCPs have to be certified to participate directly in T2S. The relevant CSD or Central Bank (i.e. the one the DCP is a participant or member of) has to ensure that the DCP fulfils all relevant conditions for participation of the DCP in T2S. T2S ensures that each DCP receives services as authorised by its CSD or by its Central Bank, and the same Service Levels. Furthermore, T2S ensures that no connected system can harm T2S or any other connected system. Before being able to access the T2S production environment, both the CSD / Central Bank and its DCP(s) therefore have to successfully pass a series of mandatory tests.

An individual T2S Actor may wish to participate as a DCP in more than one CSD or Central

T2S Framework Agreement

Schedule 5 – T2S Service Description

Bank. In such case, the T2S Actor is deemed to be a separate DCP within each CSD or Central Bank, and thus has a DCP account and related contractual arrangements with each of the CSDs or Central Bank concerned.

8.7 T2S SD.CON 070: Routing services

T2S allows duly authorised T2S Actors to configure routing information which T2S uses to deliver outgoing messages to them. Each T2S Actor can set up several routing conditions and each routing condition includes the network service and the technical address. T2S identifies the T2S Actor entitled to receive the message on the basis of on the configuration in the Common Reference Data, namely:

- the message subscription preference of the recipient; and
- the technical address to which the message should be routed (when there are multiple technical addresses, the first technical address (according to priority) is chosen).

T2S ensures that outbound messages will be routed to the appropriate technical address of the receiving T2S Actors.

T2S sends a message as a direct response upon receipt of a message, It sends the message to the T2S Actor's technical address, which was used to send the underlying message, rather than the address defined in the Common Reference Data.

9 T2S SD. SUP: Operations and support service class

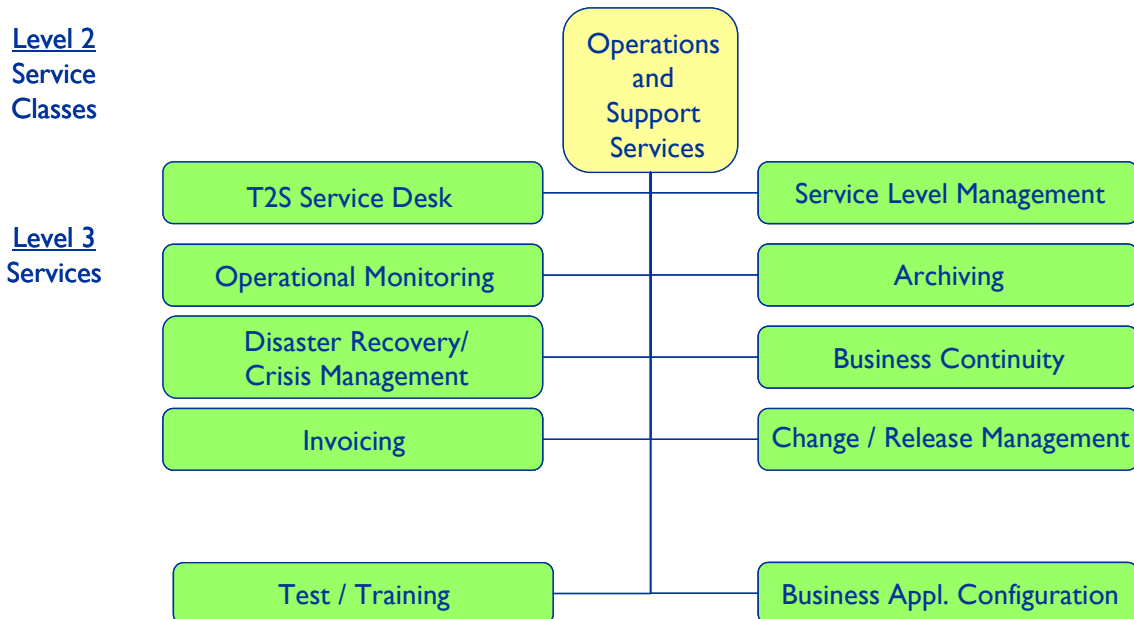

To ensure service support and delivery in accordance with agreed Service Levels, T2S uses predefined processes based on the proven Information Technology Infrastructure Library (ITIL) concept. ITIL provides a set of best practices for managing information technology (IT) infrastructure, development, and operations.

T2S Service delivery is coordinated through the operations and support services and the required activities and processes are delivered and managed in accordance with agreed Service Levels for T2S.

9.1 T2S SD.SUP 010: T2S Business Application configuration services

T2S ensures the continuous management of its configuration.

9.1.1 T2S SD.SUP 011: T2S Calendar service component

For settlement of transactions against payment/delivery and/or free-of-payment/delivery in euro or non-euro CeBM, a common calendar is defined in the Service Level Agreements, as followed by all euro area markets.

During weekends, after the end of the Friday Settlement Day, T2S moves to the Settlement Day of the following Monday and performs the related activities until the end of the night-time settlement period. On the Monday, T2S starts with the preparation of

T2S Framework Agreement

Schedule 5 – T2S Service Description

day-time settlement as the continuation of the same Settlement Day¹⁵.

9.1.2 T2S SD.SUP 012: T2S Settlement Day service component

T2S operates on a single harmonised timeframe for centralised settlement procedures in euro and non-euro CeBM. This timeframe represents a balance between the user requirements for a pan-European timetable and the constraints and business needs of existing local Schedules, and is in accordance with the market's request for harmonised post-trading practices in the EU.

T2S settlement services are available continuously during the night-time and the day-time settlement periods except for a short period during the optional Maintenance Window. T2S does not perform any settlement services outside the night-time and day-time settlement periods.

The change of the T2S settlement date defines the start of a new Settlement Day. Following the change of the Settlement Date:

- T2S validates settlement instructions against Common Reference Data valid as of the new settlement date and resulting from validated changes to the Common Reference Data; and
- T2S settles instructions on the new settlement date.

The following is an overview of the Settlement Day. A detailed description including time lines can be found in the T2S Manual of Operational Procedures (MOP):

- The Settlement Day begins with a start-of-day (“SOD”) period, starting after the change of the settlement date and ending prior to the start of night-time settlement. It includes processes that are critical for the smooth preparation of the night-time settlement procedures, such as the identification and revalidation of eligible instructions and changes to the Common Reference Data valid as from or as for this settlement date. During this period liquidity transfers from RTGS systems will be accepted.
- The following night-time settlement period starts after the end of the “SOD” period and ends prior to the Maintenance Window. During the night-time settlement period mainly settlement instructions that were input on previous Settlement Days

¹⁵ Additional detail and further rules regarding the T2S calendar can be found in the Manual of Operating Procedures (MOP)

T2S Framework Agreement

Schedule 5 – T2S Service Description

with an Intended Settlement Date that corresponds to the current settlement date are processed. The night-time settlement period consists of two settlement cycles.

- After the night-time settlement period the T2S Schedule includes a technical window for system maintenance. The optional daily Maintenance Window only occurs when urgent maintenance activities are required, while the weekend Maintenance Window is mandatory.
- After the end of the Maintenance Window T2S starts the day-time settlement period, which is used mainly for T+0 (same-day or intraday) settlement. In addition, it is during this period that failures from night-time settlement can be resolved.
- Before the End-of-Day (EOD) period starts, T2S operates different cut-off times for DvP, FoP, Central Bank operations¹⁶.

The EOD period of T2S starts after the end of the day-time processing and finishes prior to the change of the settlement date, permitting CSDs and their participants to perform critical end-of-day activities, such as fulfilling reporting requirements. From the start of the end-of-day procedure, securities and cash positions are stationary (with the exception of EOD procedures related to the auto-collateralisation as described above) since no settlement can occur until the start of the next Settlement Day's night-time settlement period.

9.2 T2S SD.SUP 020: Operational monitoring services

The T2S Operator monitors the T2S infrastructure and the T2S Business Application continuously:

- The T2S Operator observes the behaviour of the T2S production environment. If deviations from the normal Settlement Day are detected (the normal Settlement Day being defined as the behaviour of T2S over a defined time period):
 - within defined boundaries, the T2S Operator can trigger the appropriate corrective actions, when required; and
 - if necessary, the T2S Operator raises the alarms and indicates the appropriate level of priority as quickly as possible.

¹⁶ See further details in the SLA and in the MOP

T2S Framework Agreement

Schedule 5 – T2S Service Description

- In the event of operational issues the T2S Operator cannot resolve, the T2S Operator reports aggregated up-to-date monitoring information.
 - In Crisis and contingency situations, the T2S Operator provides up-to-date and comprehensive information to the crisis manager.
 - In the event of an Incident or problem, the T2S Operator provides and tracks information about the status and logs its history, as well as documenting the analysis and solution.
- The T2S Operator reports his activities to assist in the Service Performance Indicators reporting required for Service Information and monthly Service Level Agreement reporting.

9.3 T2S SD.SUP 030: Business continuity management services

Business continuity in T2S is understood to mean managing single component failures as well as failures of a single site without losing data. The Business Continuity Management service ensures that the required IT technical and services facilities (including computer systems, networks, applications, telecommunications, technical support and Service Desk) can be recovered within required, and agreed, business time-scales.

The technical environment for the T2S data centre and application follows the “two regions / four sites” architecture. Inside a region, the distance between the two sites is more than 10 kilometres. System and application software are kept updated in parallel at the four sites and each of the four T2S sites satisfies the agreed Service Levels.

Different mechanisms and procedures are implemented to guarantee business continuity:

- Single component failure
 - Hardware/Software and telecommunication components redundancy
 - Software quality control and test execution
 - Operational procedures (e.g. Change and Release Management)
- Site failure
 - Data in the two local sites are mirrored synchronous
 - Local recovery procedure to restart on alternate site

9.4 T2S SD.SUP 040: Disaster recovery and crisis management services

Disaster recovery services in T2S are understood to mean ensuring the resumption of T2S Services which were discontinued due to a high-impact disruption of normal business

T2S Framework Agreement

Schedule 5 – T2S Service Description

operations affecting a large metropolitan or geographic area and the adjacent communities that are economically integrated with it.

In addition to impeding the normal operation of financial industry participants and other commercial organisations, major operational disruptions typically affect the physical infrastructure.

Disaster recovery services ensure that the T2S Services can be recovered in an alternate region within the times defined in the Service Level Agreement. The T2S Business Application is installed in two separate regions and the data in the two regions are mirrored in asynchronous mode. Regional disaster recovery procedures are defined to restart the solution and the applications in the alternate region. Additionally, T2S uses a “periodical rotation” procedure to ensure that all staff are properly trained and both regions are capable of hosting the T2S Services.

T2S has defined a crisis management process to coordinate all activities in Crisis Situations. The crisis management process guarantees effective coordination of activities within all the involved organisations and appropriate communication, i.e. early warning and clear instructions to all concerned, if a Crisis occurs.

9.5 T2S SD.SUP 050: Archiving services

T2S provides a central archive for its own purposes covering a 10-year period. The T2S central archive includes T2S reference and Transactional Data.

T2S archives immediately all incoming and outgoing messages and files in their original format. After three months, T2S archives all instructions (settlement instruction, cash movements) as well as Common Reference Data, billing, and audit data.

In order to ensure the integrity of reference and Transactional Data, Common Reference Data revisions and Common Reference Data history remain in the operational databases until the archiving procedures moves the Transactional Data that reference it into the archiving database.

CSDs, Central Banks and T2S Operators have direct access to archived data via A2A or U2A interfaces. Provided it is duly authorised by its NCB, a DCA holder has direct access to archived data of relevance to it. Other T2S parties have to request their CSDs to retrieve and provide archived data to them.

9.6 T2S SD.SUP 060: T2S service desk services

T2S service desk provides a single, central point of contact for the CSDs, Central Banks, DCPs (if so authorised by their CSD), or DCA holders (if so authorised by their Central

T2S Framework Agreement

Schedule 5 – T2S Service Description

Bank) for handling all Incidents, queries and requests related to business, functional or technical issues related to T2S. The T2S service desk is accessible 24 hours a day on T2S operating days. The Service Levels differ depending on the time of day.

On the basis of the complexity level of the service request/ enquiry, the T2S service desk guarantees different response times, in accordance with the response time matrix as published in the Service Level Agreement. Service Levels are measured against this matrix. All enquiries are recorded, and confirmations are provided to CSDs, Central Banks or DCPs (if duly authorised by their CSDs) when service requests are received.

T2S has ITIL-based problem and Incident management processes in place:

- Incident Management - Incident Management captures the details of all Incidents reported, implements temporary work-arounds and manages the resolution of Incidents. Its goal is to restore normal service operation with minimum disruption to the business.
- Problem Management - The goal of Problem Management is to minimize the adverse impact of Incidents and “known errors” on the business. The main focus of Problem Management is to identify the root cause(s) of Incidents and to eliminate these if this is possible. While problems are being resolved Problem Management may produce temporary ‘work-arounds.’

A problem is defined as an abnormal state or condition at the component, equipment, or sub-system level, which may lead to a failure in T2S that produces incorrect or unexpected results, showing a discrepancy between the relevant specifications and the actual results. Based on reported and acknowledged problems, and their criticality, T2S and the CSDs agree how to resolve them. A problem can result in a Change Request.

9.7 T2S SD.SUP 070: Service Level management services

T2S uses a Service Level Management process to maintain and improve service quality through a constant cycle of agreeing, monitoring and reporting of service achievements and instigating actions to correct non-adequate service delivery.

T2S provides reports on actual Service Levels achieved on a monthly basis. For each service indicator as defined in the Service Level Agreement, the performance achieved is compared with the target values. These reports are provided in accordance with the rules laid down in the Service Level Agreement.

9.8 T2S SD.SUP 080: Invoicing services

Invoicing services in T2S consist of:

T2S Framework Agreement

Schedule 5 – T2S Service Description

- Automatically calculated invoices that are set up on a regular basis.
- On demand: Ad hoc invoicing in special cases (for CSDs / Central Banks and / or customers of CSDs / Central Banks).

For both types of invoices, i.e. T2S invoice to CSDs and CSD invoicing support, the invoice cannot be amended or adapted. Only

- approval;
- cancellation; and
- (re-) generation

are defined actions.

If a T2S Actor needs to receive a prior invoice (again), it can do so via a query in both A2A and in U2A mode.

9.8.1 T2S SD.SUP 081: T2S invoicing to CSDs and Central Banks service component

T2S automatically calculates invoices based on fees in accordance with the current T2S Tariff Structure and Price List. T2S invoicing reflects changes in the T2S Tariff Structure and Price List, which may be implemented at any time, but become effective only at the beginning of a billing period.

The invoice is calculated at the beginning of each calendar month for the past calendar month. All prices are calculated in Euro and VAT regimes in the different countries are taken into account, in case VAT needs to be included. Invoices and the underlying information are archived.

CSDs and Central Banks receive a summary invoice, showing aggregate data for each billing item.

The prices for instructions are always charged to the CSDs of the two counterparties involved in a settlement instruction. Each Security Account and DCA needs to be assigned unambiguously to one CSD or Central Bank for the billing of the fixed fees.

If subscribed, invoices are sent out once via push mechanism to the technical address which is defined in the Common Reference Data. The invoice can also be queried using the GUI. As an additional service, ad hoc invoicing is possible in special cases.

Changes in the Pricing scheme may be implemented at any time, but become effective only at the beginning of the next billing period.

T2S Framework Agreement

Schedule 5 – T2S Service Description

9.8.2 T2S SD.SUP 082: CSDs / Central Banks invoicing support service component

T2S supports the CSDs/ Central Banks by enabling them to invoice their clients in accordance with their individual tariff structures. To that end, as part of the T2S information services, a CSD/ Central Bank may query any of its assigned accounts, but no others.

T2S provides counters for all settlement process steps and instances as enumerated and described in the T2S data model. As part of the CSD/ Central Bank invoicing support service, each CSD/ Central Bank is able to query this level of data for each of its customer accounts.

T2S transmits details to the properly configured CSD/ Central Bank via a report based on an event at the end of the invoicing period. The CSD/ Central Bank invoicing support report provides additional information on billable items at the level of each customer account as an itemised list. This is either sent in push mode or made available for pull mode.

Furthermore, on a monthly basis T2S provides a standard report containing all detailed Transactional Data and counters for each properly configured CSD/ Central Bank which is available only to the respective CSD/ Central Bank in pull mode. Each CSD / Central Bank receives only the data related to its and its DCPs interactions with T2S, i.e. the invoicing support report is CSD-/ Central Bank - specific and does not contain any data or information concerning any other CSD/ Central Bank.

9.9 T2S SD.SUP 090: Change and Release Management services

T2S is an evolving application, increasing and improving services by following a defined Change and Release Management process. Any T2S Actor who identifies a need to change T2S, may request new or amended features and/or functionalities following the agreed Change and Release Management procedure, specified in Schedule 9 (Change and Release Management) to the T2S Framework Agreement and the T2S Currency Participation Agreement. If there are inconsistencies between the description in this section and the provisions of Schedule 9 (Change and Release Management), the latter shall prevail.

CSDs may change parameters/configuration (i.e. rules for CSD validation hold/reject and the CoSD functionality) or reference data (i.e. ISIN, Security Account) without launching the Change and Release Management, although these actions may be subject to operational procedures, in particular if there is an impact on any other T2S Actors.

T2S uses ITIL based processes for Change and Release Management: These services encompass all stages of the Change Lifecycle from initiation and recording, through

T2S Framework Agreement

Schedule 5 – T2S Service Description

filtering, assessment, categorization, authorisation, scheduling, building, testing, implementation and ultimately their review and closure.

The Eurosystem has established a Change Review Group (CRG) to evaluate the information provided in the Change Request, in the preliminary assessment (especially checking its consistency and completeness across all Change Requests) and also in the detailed assessment. The CRG is also in charge of recommending change requests for Steering Level authorisation or to reach an agreement to withdraw them. The CRG is responsible for building and maintaining the scoring mechanism as a tool for facilitating the definition of the content of each T2S release and making proposals for, reviewing and monitoring the content of T2S releases as well as any changes to any agreed release.

9.9.1 T2S SD.SUP 091: Change Management service component

Changes in T2S, which are subject to the Change and Release Management, are defined as changes on T2S functionality and/or to the Scope Defining Set of Documents. Changes may arise for a number of reasons:

- innovation and improvement – the introduction of new services/ technical capability;
- new functionality to meet business needs of T2S Parties;
- changes in law or in regulatory (including fiscal) requirements; or
- clarifications/corrections to functional and/or technical documentation/gaps in line with the user requirements.

T2S distinguishes between the following types of changes:

- according to beneficiary:

- Common Changes include new features, functionalities or services which are implemented for the benefit of – and available without restrictions to – all T2S Actors. They have an impact on all T2S Actors and the costs are shared by all T2S Actors.
- Specific Changes are any new feature, functionality or services which is not implemented as a Common Change, but which some CSDs/CBs wish to implement, and to which the other CSDs/CBs do not object. The costs of these changes are shared only by the entities using the feature, functionality or service, which is changed. The functionality is used only by the supporting parties but is made available to all T2S Actors.

- according to urgency:

T2S Framework Agreement

Schedule 5 – T2S Service Description

- Normal changes are changes that can be planned and go through the whole Change and Release Management before being implemented into the live environment.
- Fast-track Changes are changes that are imposed by Legal and Regulatory Requirements, or by T2S CSG resolutions related to risk management or changes that are critical for the stability of the T2S Platform or by Central Bank decisions related to safeguarding the currency/-ies or related to crisis management measures to ensure financial stability and that, owing to the time constraints, have to be implemented in a shorter time frame than normal, which will be decided on an ad-hoc basis. These changes will also go through the normal CRM process, however, the preliminary assessment will not apply for this cases.

Each change will be categorised based on the following parameters:

- Legal/Business importance
- Market implementation efforts
- Operational/technical impact
- Financial impact for T2S

Additionally, if the CRG agrees to recommend a change request for Steering Level authorisation following a fast-track approach, a justification for this should be included within the CR.

Every initiated Change Request is identified via a Change Request identifier. All Change Requests are published and made available to all duly authorised T2S Actors in accordance with the agreed Governance arrangements and the agreed Change and Release Management procedure, specified in Schedule 9 (Change and Release Management) to the T2S Framework Agreement and the T2S Currency Participation Agreement.

In certain cases an Incident may result in an urgent intervention on T2S aiming to ensure a quick restoration of T2S Services. On account of its urgency, such an intervention cannot be processed via the normal Change and Release Management. These Fast-track Changes are therefore processed via faster operational procedures as defined and further detailed in the Manual of Operational Procedures (MOP).

9.9.2 T2S SD.SUP 092: Release Management service component

Once the changes have been duly authorised for implementation, they are bundled and assigned to future T2S releases. The term “Release” is used to describe a collection of authorised Change Requests which consist of enhancements to the T2S Service and/or

T2S Framework Agreement

Schedule 5 – T2S Service Description

a number of bug fixes which are implemented into the production environment. A scoring mechanism is applied to identify all authorised changes and bug fixes for a specific release. The Release Management services include the planning, design, build, configuration and testing of T2S software and hardware needed for the implementation of the changes to create a set of release components.

The Release Management services ensure that all aspects of a change, technical and non-technical, are considered together. The main objective is to deliver, distribute and track one or more changes intended for simultaneous release into T2S operations while protecting the integrity of the T2S production environment and its services. Release Management services ensure that authorised changes and bug fixes that have been agreed as part of a release are secure and traceable, and that only correct, tested and authorised versions are installed into the production environment. Furthermore, through Release Management any amended legal or contractual obligations T2S has to comply with will be implemented.

Before implementing any release, T2S performs T2S-internal acceptance tests to verify that the system operates as predicted and fulfils the requirement and the functional specification of the Change Request.

Once T2S-internal acceptance test is finalised, T2S provides the CSDs and Central Banks with the test results and confirms the readiness of the T2S testing environments for the T2S User Testing. The test calendar is agreed with the CSDs and Central Banks, and information is provided on the testing activities, and regarding the availability of the testing environments.

The release is verified in accordance with the Governance arrangements, with the involvement of the CSDs and Central Banks once the exit criteria of the verification process have been completed successfully.

The delivery of the application software release into the production environment is the final step in the Release Management.

T2S provides and updates T2S Documentation as part of the Release Management.

9.10 T2S SD.SUP 100: Test and training services

9.10.1 T2S SD.SUP 101: Testing service component

The objectives of the T2S User Testing are:

- to ensure that T2S fully meets user requirements as expressed in the Change Requests of the relevant release, as well as the functional and non-functional

T2S Framework Agreement

Schedule 5 – T2S Service Description

specifications agreed by T2S; and

- to guarantee the readiness of the CSDs, Central Banks and its DCPs to operate in accordance with the agreed release.

T2S provides diverse testing environments for T2S Actor testing activities:

- one for the CSD/ Central Bank wanting to test changes in their own applications against the current T2S operating environment; and
- other(s) for the CSD/ Central Bank to test future T2S releases.

The T2S testing environments are sized and prepared for interconnection with the testing environments of the T2S Actors via test networks. T2S reserves the right to block one environment for its own regression testing of new releases.

The security levels of the testing environments are the same as for the T2S production environment. The testing environments have a substantially lower technical capacity compared to the production environment. This capacity can be increased to cover specific scenarios reported in CR-767¹⁷ and other testing needs (e.g. high-volume tests during the Community testing and the Business Day testing stages). During the T2S User Testing execution phase, the T2S operating procedures reflect as much as possible those that are agreed for live operations.

T2S testing environments use the same problem and Incident processes as the operating environment.

9.10.2 T2S SD.SUP 102: Training service component

T2S delivers training services to the CSDs, Central Banks and DCPs based on the “train the trainer”-concept. The exhaustive and self-explanatory T2S training documentation shall facilitate in-house training at CSDs, Central Banks and at their participants. The scope of the T2S training sessions covers aspects of the day-to-day activities of technical, functional and operational nature as well as one-off activities for the testing of and Migration to T2S.

T2S provide the CSDs and the Central Banks with the T2S Training Framework, on the basis of which T2S defines and elaborates the T2S Training Packages. Depending on the training delivery strategy and mode selected (inherent in the T2S Training Framework), T2S guides, delivers and provides support for the T2S training for the CSDs and for the

¹⁷ CR-0767 Technical enhancement of the EAC environment to support migration and volume testing

T2S Framework Agreement

Schedule 5 – T2S Service Description

Central Banks.

The T2S Training Framework is elaborated and rolled out so that a timely and efficient knowledge transfer to the end-users of T2S can be accomplished. The T2S Training Framework further clarifies and details all organisational and planning aspects related to the training.



EUROPEAN CENTRAL BANK
EUROSYSTEM

T2S FRAMEWORK AGREEMENT

SCHEDULE 6

T2S SERVICE LEVEL AGREEMENT

T2S Framework Agreement

Schedule 6 – T2S Service Level Agreement

Table of contents

1	Introduction	4
2	Parties, commencement date and scope	5
2.1	Identification of the Parties	5
2.2	Scope.....	5
2.3	Commencement date	5
3	Service responsibilities	6
3.1	Eurosystem’s responsibilities	6
3.2	Contracting CSD’s responsibilities	8
3.3	Operational Procedures.....	9
3.4	Technical neutrality.....	10
4	Service Levels in the production environment	11
4.1	Definitions of Service Level Indicators.....	11
4.1.1	<i>Service availability</i>	11
4.1.2	<i>Response Times</i>	17
4.1.3	<i>Support Hours and Incident Response Times</i>	20
4.1.4	<i>Business Continuity and Disaster Recovery</i>	25
4.2	Committed Service Levels for the Production Environment	26
4.2.1	<i>Operational and Support Services</i>	26
4.2.2	<i>Settlement Services and Liquidity Management Services</i>	29
4.2.3	<i>Reference Data Services</i>	30
4.2.4	<i>Information Services</i>	30
4.2.5	<i>Connectivity Services</i>	31
4.3	Targeted Service Levels for the Production Environment	31
4.3.1	<i>Settlement Services and Liquidity Management Services</i>	31
4.3.2	<i>Information Services</i>	32
5	Service Levels for the Test Environments	33
5.1	Service Levels for the Pre-production environment	33
5.1.1	<i>Operational and Support Services</i>	33
5.2	Service Levels for the Interoperability test environment.....	33
5.2.1	<i>Operational and Support Services</i>	33
5.3	Additional provisions	34
6	System Capacity and Platform Sizing	36
7	Service Level Reporting	38
7.1	Content of the Reporting.....	38
7.2	Definition of Additional Indicators for Reporting	39
7.2.1	<i>File throughput</i>	39
7.2.2	<i>Batch Settlement throughput</i>	39
7.3	T2S Operations report	40
8	Monthly Service review meetings	41

T2S Framework Agreement

Schedule 6 – T2S Service Level Agreement

9	Annual SLA reviews	42
	Annex 1 - Management of non-functional changes	44
1.	Emergency Changes	44
2.	Other changes	44

T2S Framework Agreement

Schedule 6 – T2S Service Level Agreement

1 Introduction

This Service Level Agreement (SLA) documents the commitments of the Parties to each other, in particular the Service Levels under which the Eurosystem will provide the T2S Services to the Signatory CSDs that have entered into the T2S Framework Agreement with the Eurosystem. The main objective of this document is to describe the Service Levels agreed between the Parties and to define the Key Performance Indicators (KPIs) used to measure these Service Levels.

This SLA assigns responsibilities to and describes interactions between the Parties. This SLA does not constitute liability other than specified in the provisions laid down in the T2S Framework Agreement.

This SLA is part of the legal arrangements between the Eurosystem and CSDs, under the T2S Framework Agreement. Unless explicitly mentioned this SLA is the same as the one concluded with all other CSDs. It is the intention of the Parties to reach the highest possible level of harmonisation between all SLAs. The commitments of the Eurosystem and the CSDs set out below will not be altered without mutual agreement, subject to the agreed overarching governance of T2S.

Annex 1 (Management of non-functional changes) to this document covers the process to manage non-functional changes needed to maintain the agreed Service Levels, or to increase them as a result of the SLA review process.

T2S Framework Agreement

Schedule 6 – T2S Service Level Agreement

2 Parties, commencement date and scope

2.1 Identification of the Parties

The Parties to this Service Level Agreement are the Eurosystem and the Contracting CSD.

The Directly Connected Parties (DCPs) do not have a direct legal relationship with the Eurosystem for the use of T2S Services. Nevertheless, they will obtain certain rights and be subject to certain obligations from this SLA through the mandatory inclusion of certain provisions in their legal arrangements with their CSD(s). These provisions are explicitly reflected in section 3.2 of this SLA.

2.2 Scope

This SLA refers to the T2S Production environment and its accompanying test environments. It covers the full range of services as described in Schedule 5 for each of the service classes, i.e. Settlement Services, Liquidity Management Services, Reference Data Management Services, Information Services, Connectivity Services, and Operational and Support Services. In addition, this SLA covers the relevant service commitments from the Eurosystem with respect to the support of the User Testing activities as specified in Schedule 3 (User Testing).

2.3 Commencement date

This SLA shall enter into force as from the day the Contracting CSD starts its User Testing activities on the T2S Platform. More specifically, as from that day until the Contracting CSD's Migration, the provisions with respect to the T2S test environments, as specified in chapter 5, will apply.

T2S Framework Agreement

Schedule 6 – T2S Service Level Agreement

3 Service responsibilities

3.1 Eurosystem's responsibilities

The Eurosystem must:

- a) establish the T2S service desk as a single point of contact for the Contracting CSD (for technical and operational problems) and provide the contact details (e-mail, mobile phone, telephone);
- b) support the Contracting CSD in their operational management of direct links for the CSD and DCPs if needed;
- c) ensure the permanent reachability of an ECB Crisis manager, T2S Operator's Crisis manager, T2S Service manager and T2S co-ordinator and provide their contact details (e-mail, telephone);
- d) refrain from scheduling system downtimes without pre-advice and green light of the Contracting CSD outside the Maintenance Windows;
- e) announce planned non-functional changes according to the provisions specified in Annex 1 to this Schedule;
- f) provide on-line access to information to allow the Contracting CSD to track and follow up all Incidents, problems and release defects related to or impacting the Contracting CSD;
- g) provide a monthly Service Level Report to the Contracting CSD according to the provisions in section 7 of this SLA;
- h) manage the impact on the Contracting CSD and the T2S Service as a whole caused by any T2S Actor making unusual demands on capacity by:
 - contacting the User without delay if the latter misbehaves, misuses T2S or consumes system resources in any other way to an extent that exceeds the forecasted capacity and might prevent the Eurosystem from delivering the agreed service to other Users;
 - denying (up to and including temporary disconnection) providing the service to a User if
 - i) threatening the stability of the platform impacting other Users and ii) not responding effectively to the Eurosystem's request to prevent further misbehaviour;
- i) deny the service by disconnecting any User that did not respond effectively to a request from the Eurosystem to prevent a recurrence of previous misbehaviour and that continues to threaten the stability of the platform with impact on other Users, until the User has demonstrated that the threat no longer exists;
- j) provide to the Contracting CSD historical data on the previous four quarters on the parameters laid down in section 6 of this SLA in order to facilitate the Contracting CSD's forecasting of business data for the next four quarters. The historical data will include the historical data of its DCPs;
- k) the Eurosystem shall translate the Contracting CSD's forecasts into metrics that are relevant for estimating the T2S system capacity (ceiling);

T2S Framework Agreement

Schedule 6 – T2S Service Level Agreement

- l) ensure an adequate long-term planning for capacities corresponding to the requirements laid down in section 6 of this SLA;
- m) inform the Contracting CSD if technical problems with one of its Directly Connected Parties (DCPs) are detected.
- n) maintain documentation pertaining to Crisis management and provide it to the Contracting CSD on request or after any change;
- o) support the Contracting CSD in business continuity testing if required (subject to prior agreement).

During **normal operation**, the T2S co-ordinator (appointed by the Eurosystem), the T2S service manager (appointed by the T2S Operator) and the settlement managers of the Contracting CSD and Participating CSDs (appointed by each CSD) and the Central Banks settlement managers (appointed by each Central Bank) will apply the procedures specified in the Manual of Operational Procedures (see also section 3.3).

In addition, the Eurosystem stands ready to provide through the T2S service desk:

- information on technical and operational issues, in particular the running of T2S;
- information on T2S functionality;
- up-to-date information concerning the running of T2S, if need be.

If a **Crisis Situation** arises within the domain of the Eurosystem, the latter will inform the Contracting CSD according to the agreed response times.

In addition, the following provisions will apply in such case:

- The Eurosystem will take all necessary actions to restore the T2S Service according to the agreed business continuity procedures. These procedures are based on the following key principles:
 - Any settlement in T2S before the Incident will continue to have the legal effect specified in Article 21.4 of the core T2S Framework Agreement.
 - If a data loss materialised, the recovery will be done together with the Signatory CSD by procedural means.
- As soon as the Eurosystem identifies the need to switch to the other site in the same region, or to fail-over to the standby region, the T2S co-ordinator initiates a teleconference to the Contracting CSD about the nature of the event triggering the failure, the nature of the failure and the envisaged plan to recover from the failure.
- The Eurosystem will keep the Contracting CSD informed about the progress of the failover activities, and in particular when T2S is available again for normal operations.
- The Eurosystem may decide to gradually re-open T2S, in which case it will seek the approval of the Contracting CSD.
- In case T2S cannot be restarted without a potential data gap, the Eurosystem will first re-open T2S for the purpose of reconciliation only and will co-ordinate these reconciliation activities.

T2S Framework Agreement

Schedule 6 – T2S Service Level Agreement

- During this reconciliation phase, the Contracting CSD is responsible to verify the status of its T2S records, and to re-send instructions with the aim to bring the T2S records consistent with its internal records. This includes also changes to the T2S records that happened as a result of an interaction with a DCP belonging to the Contracting CSD. It is up to the Contracting CSD to agree with its DCPs how this is organised.
- The Eurosystem and the Contracting CSD will co-operate in good faith and will - if necessary - agree on additional measures with the aim to close the data gap.
- The Eurosystem will seek the agreement of the Crisis managers of the Contracting CSD and the Participating CSDs and the of the Crisis managers of the Central Banks to re-open T2S for normal operations.
- The Eurosystem will provide any service described for normal operations but balancing this with the need to restore the service.
- Throughout the whole Crisis management process, the Eurosystem will appropriately involve the DCPs, in accordance with the arrangements agreed with the Contracting CSD and Participating CSDs.

Detailed procedures for Incident priority setting and Incident handling will be specified in the Manual of Operational Procedures (MOP).

3.2 Contracting CSD's responsibilities

In order to allow the Eurosystem to meet the agreed Service Levels, the Contracting CSD must:

- a) appoint and ensure the permanent reachability of a CSD settlement manager and a CSD Crisis manager as contacts for the Eurosystem and provide their contact details (e-mail, telephone, mobile phone);
- b) provide contact details for technical staff that is capable of resolving technical issues with their Directly Connected Parties (DCPs);
- c) have a local service desk acting as a single point of contact for all its Users during normal business hours;
- d) proactively report any problem or Incident relating to T2S including connectivity problems, provide all information that might be helpful and cooperate where requested by taking all appropriate actions for solving the problem or Incident;
- e) report such problems or Incidents to the T2S service desk within a reasonable time;
- f) provide timely information on any changes that may affect the provision of the T2S Services;
- g) ensure an appropriate use of T2S and that the personnel who works on its systems and equipment is accordingly qualified and suitably trained;
- h) ensure availability of skilled staff within a pre-agreed time period in order for the Eurosystem to obtain support in handling Incidents and/or reducing their impact on the service;
- i) provide on a quarterly basis updated forecasts for average business figures, to allow the Eurosystem to make an adequate long-term capacity planning (see section 6 of this SLA). The

T2S Framework Agreement

Schedule 6 – T2S Service Level Agreement

Contracting CSD shall produce forecasts, in good faith, on a best effort basis, on the basis of (i) historical data provided by the Eurosystem, and (ii) information available to CSDs about their future business (at the moment of providing the forecast);

- j) be able to resend – at the request of the Eurosystem – all messages already sent after a specified recovery point during the same Settlement Day (approx. one minute - in particular in case of disaster recovery scenarios with possible data loss);
- k) keep all access rights it has registered for access in T2S consistent with the duties and responsibilities of its employees;
- l) ensure with the support of the Eurosystem that all its Directly Connected Parties (DCPs) receive, accept and understand all information to facilitate their smooth functioning in T2S;
- m) ensure the operational management of its own organisation as well as their customers including DCPs;
- n) ensure the operational management of the technical links to T2S from the CSD and DCPs with the support of the Eurosystem if needed;
- o) take part in the test process for new releases in the test environments;
- p) co-operate with the Eurosystem by promptly reporting any difficulties however small following each release into the production environment;
- q) support the Eurosystem in business continuity testing if required.

3.3 Operational Procedures

The Manual of Operational Procedures (MOP) will provide a reference guide for the operational procedures (in normal and abnormal situations) which the Directly Connected T2S Actors (including the Contracting CSD) and the Eurosystem should follow to ensure a smooth functioning of T2S. It will contain all the information required for the addressees to carry out all their tasks in normal and abnormal situations.

The day-to-day operational management of T2S will be handled at two levels. First, the T2S co-ordinator, the T2S service manager, the CSDs Settlement managers and the Central Banks Settlement managers (jointly called the “Settlement managers”) will jointly perform the tasks and apply the procedures as specified in the MOP. Second, the ECB Crisis manager, the T2S Operator Crisis manager, the CSDs Crisis managers and the Central Banks Crisis managers (jointly called “the Crisis managers”) will follow the operational procedures as described in the MOP, and will take over the management of T2S in situations that are not covered in the MOP. The Crisis managers will be assisted and advised by the settlement managers in that case.

The latter includes the Business Continuity and Disaster Recovery arrangements, i.e. the set of rules and procedures aimed at resuming the normal T2S Services after the occurrence of an Incident, as well as at mitigating the impact of such Incident. The key principles for the Incident management can be summarised as follows:

T2S Framework Agreement

Schedule 6 – T2S Service Level Agreement

- If the Contracting CSD detects an Incident that is related to or might have an impact on the T2S Services, it will inform the Eurosystem without undue delay.
- If the Eurosystem detects an Incident, it will be communicated to the Contracting CSD, if a direct or indirect impact is possible.
- If an Incident is reported by a DCP of the Contracting CSD, the Eurosystem will inform the latter without undue delay and keep the Contracting CSD informed about the resolution path of such Incident. Any action to escalate such Incident, will be undertaken in close co-operation with the Signatory CSD.

Both sides will co-operate to reduce the impact of an Incident.

As far as the Incident management procedures defined in the MOP allow to handle a particular Incident, the T2S coordinator (appointed by the Eurosystem), the T2S service manager (appointed by the T2S Operator), and the Settlement managers (appointed by each Central Bank and by each CSD respectively) will co-operate in good faith and exchange all relevant information that is necessary to handle the Incident as specified in the MOP.

When the Incident cannot be handled within the procedures specified in the MOP, the ECB Crisis manager (appointed by the Eurosystem), the T2S Operator Crisis manager, the Central Banks Crisis managers (appointed by each Central Bank) and the CSDs Crisis managers (appointed by each CSD) will decide – in accordance with the applicable governance arrangements – which measures will be taken to mitigate the impact of the Incident and to resume normal operations.

Both sides will co-operate in analysing the root-cause for an Incident.

The Eurosystem will report on the results of the root-cause analysis. An initial report with the impact analysis will be provided within two Settlement Days. An interim report, which is optional, will be provided only upon OMG request and a final report within ten Settlement Days.

Whether or not a request to change a cut-off time, either from the Eurosystem or from the Contracting CSD, is related to an Incident, the Eurosystem will involve the Settlement managers and/or the Crisis managers in making such decision, according to the procedures further specified in the MOP.

3.4 Technical neutrality

As a matter of principle, the Eurosystem shall make reasonable efforts to ensure that, in normal circumstances, no Directly Connected T2S Actor receives a different Service Level based on historic or forecasted volumes, its name, its country of legal incorporation or of the location of its data centres, or any other factor. Abnormal circumstances might require a temporary deviation from this principle.

T2S Framework Agreement

Schedule 6 – T2S Service Level Agreement

4 Service Levels in the production environment

This section describes the Key Performance Indicators (KPIs) agreed for the delivery of the service during **normal operations**. As a general principle, the Eurosystem has to ensure that sufficient efforts are made to fulfil all KPIs and must take remedial action as soon as it detects that a KPI may not be, or is not, fulfilled.

The Contracting CSD is committed to provide all reasonable support to the Eurosystem, in order to allow the latter to take such action.

T2S is a service shared between several Users. All specified Service Levels are therefore multilateral service levels, i.e. they define the service provided to the community as a whole. Nevertheless, the service level reporting will contain the achieved bilateral service levels for the Contracting CSD in addition to the achieved multilateral service levels.

4.1 Definitions of Service Level Indicators

This chapter provides a common definition of the service level indicators. While Section 4.1.1 covers the service availability, Section 4.1.2 lists the response times and Section 4.1.3 covers support and recovery issues. The actual agreed levels are stated for each service individually in section 4.2 below.

The time by which a service or function needs to be provided, as indicated in this Schedule, is expressed in 24-hour time format, and is intended as the time applying to the seat of the ECB i.e. Frankfurt time.

4.1.1 Service availability

Objective:

These indicators define the times during which the T2S Services are available in relation to the T2S Settlement Days.

4.1.1.1 Availability period

The availability period is the time period during the T2S Settlement Day when the service is stated as expected to be available to the Contracting CSD. The start and end time of the availability period is based on business events on the T2S Platform. Any times stated are indicative and could be altered in certain circumstances according to the Procedures specified in the Manual of Operational Procedures (e.g. delay of the end-of-day).

T2S Framework Agreement

Schedule 6 – T2S Service Level Agreement

4.1.1.2 Availability

Definition:

A service is considered to be available when it responds and operates according to its definition in the T2S Service Description and its functional description in the User Detailed Functional Specification (UDFS chapter 1).

Measurement:

The availability of the services is measured continuously and objectively at predefined components of T2S, throughout each Settlement Day with the exclusion of the Maintenance Window.

The measurement of downtime is based on auditable data collected either automatically or manually. Manual measurements will be used in situations where no automatic log entries are available (e.g. power failure).

Downtime is the time between the start of an Incident that causes the unavailability of a service and the closing of the Incident that caused the downtime, i.e. when the service has been restored. In case of multiple Incidents at the same time the downtime begins with the start of the first Incident and ends with the closing of the last Incident.

Calculation:

$$a_i = \left(1 - \frac{d_i}{T_m}\right) \times 100$$
$$a = \sum_{i=1}^n a_i \times w_i$$

Where:

a_i = availability of the service i as percentage

d_i = cumulative downtime of the service i for the reporting period

T_m = total planned up-time for the reporting period

w_i = weight of the service i

a = weighted availability as percentage

The availability of a service is expressed as a percentage of the aggregated downtime in relation to the aggregated expected up-time during the reporting period. The calculation is based on minutes.

The weights of the service (w_i) used in the KPI calculations will be documented in the T2S Manual of Operational Procedures (T2S MOP), as amended from time to time.

4.1.1.3 Punctuality and substantial delay

Definition:

T2S Framework Agreement

Schedule 6 – T2S Service Level Agreement

If (i) an event defined in the T2S daily schedule and included in the agreed subset of events or (ii) a T2S process¹ is likely to start or finish² later than the original scheduled/agreed time and has a potential impact on the Contracting CSD, the substantial delay defines for each event the maximum delay that will be tolerated by the Contracting CSD. Any delay or expected delay exceeding the substantial delay will be communicated to the Contracting CSD immediately.

Any delay not exceeding the substantial delay is not actively communicated to the Contracting CSD but is available for querying on the T2S Platform.

In addition, for some events and phases of the T2S daily schedule, a maximum duration is agreed upon, and any delays with the duration of those events and phases will have to be communicated to the Contracting CSD immediately.

Events delayed upon request of the Contracting CSD, Participating CSDs or of Central Banks do not fall into the substantial delay category – the agreed time span of the aforementioned delay(s) shall not be accounted for the computation of the phases or processes relevant for the KPI on duration.

Measurement:

The punctuality of T2S is measured by counting the number of occasions when:

- the start of the selected T2S business events is delayed for a time period exceeding the defined substantial delay (4.2.1);
- the end of the selected T2S business events is delayed for a time period exceeding the defined substantial delay (4.2);
- the duration of the predefined periods of the Settlement Day exceeds the agreed values (4.2.1).

and is expressed as a percentage value encompassing the overall number of occurrences against the number of Settlement Days in the reporting period

$$p = \left(1 - \frac{d_i}{o_i \times b_i}\right) \times 100$$

Where:

p = punctuality of the service as percentage

d = cumulative number of times where an event was delayed for the reporting period

o = total number of predefined events occurring in the reporting period

b = number of Settlement Days in the month

¹ This applies to monthly Billing process only. It consists of calculation of charges for the consumption of T2S Services and the sending of the corresponding invoices to the CBs/CSDs.

² This applies to the Monthly Aggregated Amounts Report event (MAGG) and the monthly Billing Process only.

T2S Framework Agreement

Schedule 6 – T2S Service Level Agreement

Measurement:

The delays in the start of an event will be checked using the planned and the actual start time stamps for the relevant events as logged by T2S. The following events are relevant for this calculation:

- EUR Intraday Delivery versus Payment (DVP)³ cut-off
- DKK Intraday Delivery versus Payment (DVP)⁴ cut-off
- DKK Generate Outbound LT (GOLT)
- Intraday Free of Payment (FOP) cut-off (IFOP)
- Change of the business day completed (BDCD)
- Start of Cycle 1 / Preparation of Sequence 0 (C1P0)
- Maintenance Window Completed (MTWC)

The delays in the end of an event will be checked using the committed end timestamp and the actual end timestamp for the relevant events as logged by T2S. The following events are relevant for this calculation:

- Monthly Aggregated Amounts Report event (MAGG)⁵

The following periods or processes of the Settlement Day are relevant for the calculation of the KPI on the duration:

- Start of Day: from the start of the event BDCD to the end of the event End of Start of Day (ESOD)
- Night-Time Settlement: from the start of C1P0 until the end of the NTS reporting (Event ENTS)
- End of Day: from the Start of the End of Day (SEOD) until the End of Day Reports (EEOR)
- Start of the RTS after the MTNW
- Duration of the IDVP cut-off

Penalty Mechanism daily processes: from the start of the event for the deadline for provision of penalty reference data (PMDD) to the end of last event to close, i.e. the event for reporting modified penalties (MDPL) or the event for reporting new daily penalties (DAPL).

Monthly Billing process: the end of the process is marked by the provision of the T2S invoices on the first Settlement Day of the month to the CSDs/CBs.

³ Please see T2S Framework Agreement, Schedule 1 – Definitions.

⁴ Please see T2S Framework Agreement, Schedule 1 – Definitions.

⁵ The delay over the committed end time of the event (09:30) is only relevant on the Business Day of the month when the Monthly Reporting of the Penalty Mechanism takes place. Hence, it will be excluded from being expressed as a percentage value following the measurement defined for the rest of punctuality and delay indicators.

T2S Framework Agreement

Schedule 6 – T2S Service Level Agreement

4.1.1.4 System performance

Objective:

These indicators define the system performance the Contracting CSD is expecting from the T2S Platform. T2S will be sized as a single shared environment on the basis of data supplied by the Contracting CSD and the Participating CSDs (see chapter 6), with a margin for exceptional peaks (see 4.2.2).

If the volumes processed in production exceed the estimated T2S system capacity, i.e. ceilings (see chapter 6), service performance commitments are not binding for the Eurosystem. In such scenario the operational day shall not be affected i.e. the T2S platform shall function without Incident and without the potential need of actions from the Contracting CSDs.

In case the volumes exceed also the margin envisaged for the exceptional peaks (see 4.2.2), the service performance commitments are also not binding. In such scenario service performance breaches may occur and Incident management procedures are applied with the potential need of actions from the Contracting CSD to resolve the Incident.

4.1.1.5 Technical Validation Time

Definition:

Technical Validation time indicator takes into account the time elapsed between the sending out of the acknowledgement message (after the reception of the request message) and the time the instruction is received by T2S, i.e. the time the instruction is passed on to the back-end module.

Measurement:

The Technical Validation Time is measured based on timestamps created by the T2S network interface (i.e. from the moment the technical ACK is sent out) and the timestamps measured at application level i.e. INTF and stored as part of the audit trail in the T2S database.

This KPI does not apply during the 10 minutes following either the end of the weekly Maintenance Window or the end of a daily Maintenance Window after a T2S closing day and during the EoD reporting phase⁶.

4.1.1.6 Business Validation Time

Definition:

The Business Validation Time is the time that elapses between the reception of an instruction by T2S and the end of the business validation process, i.e. the time when T2S triggers the generation of the acceptance or rejection message.

Measurement:

⁶ The EOD reporting phase is marked by the start of event EESR and the closure of event EEOR.

T2S Framework Agreement

Schedule 6 – T2S Service Level Agreement

The Business Validation Time is measured based on timestamps created by the T2S network interface and the timestamps stored as part of the audit trail in the T2S database. The settlement instructions and restrictions that are checked either against restriction types configurations with more than 10 market-specific attributes or a restriction type rule with more than 5 market-specific attributes, as well the instructions with linked settlement instructions and restrictions above 50 are excluded from the calculation.

This KPI does not apply during the EoD reporting phase⁷.

4.1.1.7 Matching time

Definition:

The Matching time is the time that elapses between the end of a successful business validation and the end of the first Matching attempt. The end of a Matching attempt is marked by the time T2S triggers the generation of the Matching status notification message or the detection that there is not yet a Matching instruction available.

Measurement:

The Matching time is measured based on timestamps stored as part of the audit trail in the T2S database.

4.1.1.8 Real-time Settlement time

Definition:

The Real-time Settlement time indicator covers the period between the end of the creation of the matching object (i.e. after successful matching) and the end of the first settlement attempt. The end of the settlement attempt is marked by the time T2S triggers the generation of the settlement status notification message.

The Real-time Settlement time indicator is relevant only for settlement instructions sent on the Intended Settlement Date after the start of the Real-time Settlement phase of T2S (marked by event STDN).

Measurement:

The Real-time Settlement time is measured based on timestamps stored as part of the audit trail in the T2S database.

Additional remarks:

For the T2S settlement process several cut-off times have been defined. The T2S Platform will ensure that each settlement instruction that has been sent and acknowledged before the relevant cut-off time will get at least one settlement attempt.

⁷ The EOD reporting phase is marked by the start of event EESR and the closure of event EEOR.

T2S Framework Agreement

Schedule 6 – T2S Service Level Agreement

All Settlement Instructions using realignment, CoSD, resorting to auto-collateralisation or sent with business links (link with or pool) that exceed the agreed KPI as a result of the additional processes involved, will be mentioned separately in the SLA Report.

4.1.1.9 Reference data processing time

Definition:

The reference data processing time is the time that elapses between the end of a successful business validation and the end of the processing of this request.

This indicator is relevant only for all types of reference data maintenance instructions.

Measurement:

The reference data processing time is measured based on timestamps stored as part of the audit trail in the T2S database.

Additional remarks:

In Batch Settlement mode certain types of reference data maintenance requests might be queued to ensure the consistency of the settlement processing. In these cases, the processing is considered complete after the creation of a new revision for the relevant entities even though this revision is only activated at a later point in time.

4.1.2 Response Times

Objective:

Time indicators provided in the following sections are always measured within the T2S perimeter under the responsibility of the Eurosystem as shown by the dashed line in the diagram below. The actual transmission time of the data via the network between T2S and the Contracting CSD is not included in the response time.

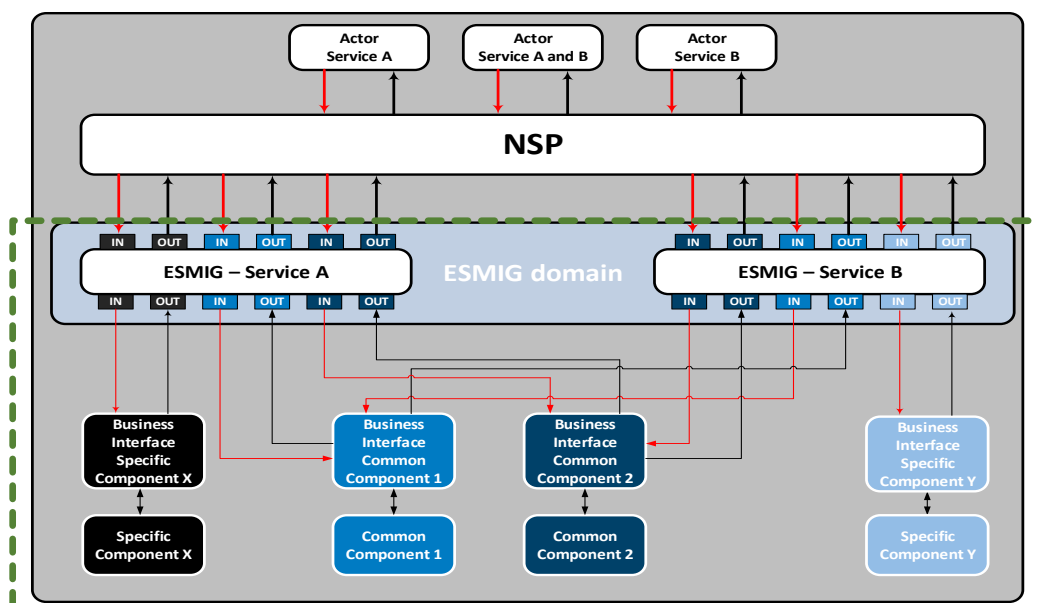

T2S Framework Agreement

Schedule 6 – T2S Service Level Agreement

The response time indicators define the time period between the reception of a request and the corresponding response of the T2S Platform. All performance indicators are measured during each T2S Settlement Day during the time window when the information services are expected to be available.

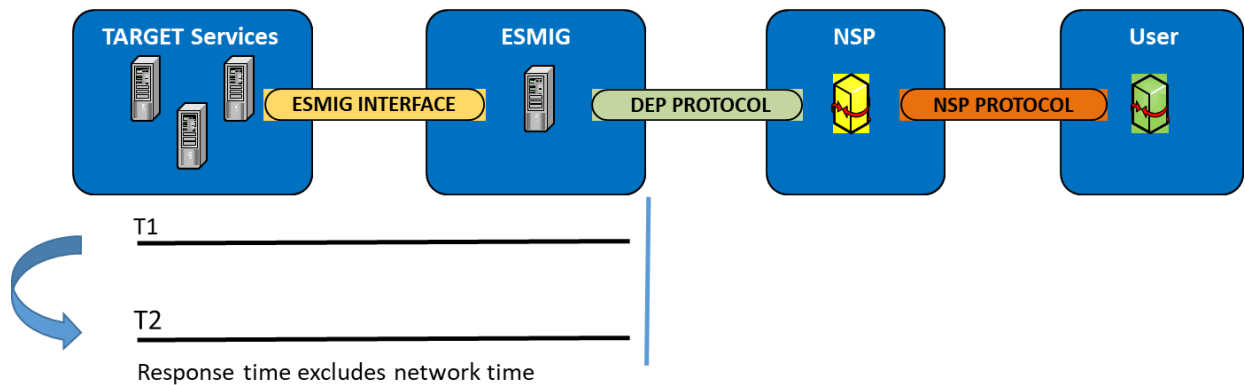

Additional remarks:

All messages that have been queued during the Maintenance Window and queries that have been queued during Batch Settlement will not be included in the calculation of the response times.

Simple queries and complex queries are those referenced as such within the User Detailed Functional Specifications (UDFS).

4.1.2.1 A2A query response time

Definition:

For A2A query requests the response time is defined as the time elapsed between the reception of the query request message and the completion of the sending out of the corresponding result message (see diagram above).

Measurement:

The response times for A2A queries are measured using the timestamps generated by the T2S network interface.

The KPI does not apply for queries processed during throughput peaks exceeding 3 queries per second and to queries messages processed during the End of Day Reporting phase⁸ where the system load is generally very high and several processes are running concurrently.

⁸ The EOD reporting phase is marked by the start of event EESR and the closure of event EEOR.

T2S Framework Agreement

Schedule 6 – T2S Service Level Agreement

4.1.2.2 A2A message response time

Definition:

For all A2A requests other than A2A queries the response time is defined as the time elapsed between the reception of the request message by T2S and the sending out of the corresponding acknowledgement message (see diagram above). This KPI does not apply for request messages sent within files.

Measurement:

The response times for A2A requests are measured using the timestamps generated by the T2S network interface.

4.1.2.3 A2A response time for messages bundled in files

Definition:

For all A2A requests bundled into files, the response time is defined as the time elapsed between the reception of the request file by T2S and the sending out of the corresponding acknowledgement message (see diagram above).

The acknowledgement message is only generated once the last message of the file has been processed.

Measurement:

The response times for A2A requests bundled into files, are measured using the timestamps generated by the T2S network interface.

4.1.2.4 U2A response time

Definition:

For all U2A requests the response time is defined as the time needed by the system to generate a web (HTML) page (i.e. the time it takes the server to generate the page, plus the time it takes the proxy to download the content from the server).

Measurement:

For U2A requests the response time is measured by the T2S Platform within the Eurosystem's domain. In order to limit the effect of queries with a large number of business objects retrieved the response time is computed assuming that the duration of each U2A request is equal to the monthly average response time of that kind of web page weighted by the frequency of the function invoked.

Calculation:

$$\frac{(a_1 * v_1) + (a_2 * v_2) + [...] + (a_n * v_n)}{h}$$

Where

a = average generation time of a functional category of GUI pages;

T2S Framework Agreement

Schedule 6 – T2S Service Level Agreement

v = number of unique page views for each category of GUI pages;

h = total number of unique page views of T2S GUI pages.

4.1.2.5 Online storage period

The online storage period defines the minimum time T2S keeps Transactional and Reference Data available online. For Transactional Data entities this period starts when the entity reaches its final status (i.e. settled, cancelled, etc.). For Reference Data entities this period starts when the entity is no longer active and no longer referenced from a Transactional Data entity.

4.1.2.6 Archiving period

The archiving period defines the minimum time T2S keeps Transactional and Reference Data available in an archive for retrieval by the Contracting CSD. For Transactional Data entities this period starts when the entity reaches its final status (i.e. settled, cancelled, etc.). For Reference Data entities this period starts when the entity is no longer active and no longer referenced from a Transactional Data entity.

4.1.2.7 Archive retrieval response time

Definition:

The archive retrieval response time is defined as the time elapsed between the reception of an archive retrieval request and the sending out of the corresponding notification that the data is available for download.

Measurement:

The archive retrieval response time is measured using the timestamps generated by the T2S network interface.

4.1.3 Support Hours and Incident Response Times

These indicators define the response times of the T2S service desk in relation to the type of Incident/request and the T2S Settlement Days.

Incidents will be categorised in different priority classes considering both the impact on the availability of T2S Services as well as on Data Integrity and Confidentiality: the overall priority of an Incident is always equal to the highest reported among the three impact categories. The KPI for resolution time for each priority class is defined in 4.2.1.

T2S Framework Agreement

Schedule 6 – T2S Service Level Agreement

Incident Priority	Severity	Availability Impact	Data Integrity Impact	Confidentiality Impact
1	Critical	Complete unavailability of all T2S Services Complete unavailability of one or more services for which no workaround is available.	Massive data corruption, sensitive or proprietary information was changed or deleted, causing degradation or disruption of vital service(s), or affecting a large number of entities, involving a serious breach of network security, and there is a high reputational impact, e.g. <ul style="list-style-type: none"> • Credibility affected over the long term (> 3 years) • Series of credible, verified and very negative pieces of information, and/or opinions • International media coverage extended to the popular press, TV and radio. 	Massive extrusion of sensitive or proprietary information and there is a high reputational impact, e.g.: <ul style="list-style-type: none"> • Credibility affected over the long term (> 3 years) • Series of credible, verified and very negative pieces of information, and/or opinions • International media coverage extended to the popular press, TV and radio

T2S Framework Agreement

Schedule 6 – T2S Service Level Agreement

2	Urgent	Unavailability of a service, but a workaround is available	<p>Significant data corruption, sensitive or proprietary information was changed or deleted, causing the degradation or disruption of non-essential service(s) or affecting a small number of entities, involving a breach of network security policy, and there is a medium reputational impact, e.g.</p> <ul style="list-style-type: none"> • Credibility affected over the medium term (1 - 3 years) • Credible and negative pieces of information, and/or opinions • International media coverage including most internationally recognised newspapers 	<p>Significant extrusion of sensitive or proprietary information and there is a medium reputational impact, e.g.:</p> <ul style="list-style-type: none"> • Credibility affected over the medium term (1 - 3 years) • Credible and negative pieces of information, and/or opinions • International media coverage including most internationally recognised newspapers.
---	--------	--	---	---

T2S Framework Agreement

Schedule 6 – T2S Service Level Agreement

3	Medium priority	All services are available, but some are experiencing performance problems	<p>Limited data corruption, sensitive or proprietary information was changed or deleted, causing the degradation of non-essential service(s), without affecting external entities, and there is a low reputational impact, e.g.</p> <ul style="list-style-type: none"> • Credibility affected over short term (< 1 year) • Negative pieces of information, and/or opinions • Media coverage in one or a few internationally recognised newspapers 	<p>Limited extrusion of sensitive or proprietary information low reputational impact, e.g.:</p> <ul style="list-style-type: none"> • Credibility affected over short term (< 1 year) • Negative pieces of information, and/or opinions • Media coverage in one or a few internationally recognised newspapers
4	Low priority	Query or service request	No impact.	No impact.

T2S Framework Agreement

Schedule 6 – T2S Service Level Agreement

4.1.3.1 Support hours

Definition:

The T2S service desk can be contacted via telephone or e-mail by the Contracting CSD. During standard support hours the T2S service desk can be contacted to communicate technical or business problems on the Contracting CSD's side, open tickets for failures of T2S and receive support by the T2S Operator. During non-standard support hours the T2S service desk should be initially contacted via telephone to communicate information that is urgently needed or useful to avoid or limit any negative impact on daily operations, as e-mails will not be monitored during this time. Any e-mail request that is sent during this time will be processed during the next standard support hours only unless it is preannounced by a telephone call and related to an ongoing priority class:1 or priority 2 Incident started outside standard support hours (see above).

4.1.3.1 Incident response time

Definition:

The Incident response time is defined as the time between the Incident being detected or information about the Incident received by the Eurosystem and the start of the action to resolve the Incident.

Measurement:

Upon acceptance of an Incident or service request the T2S service desk will assign a reference number and a priority level (see section 4.1.3) to it. The reference number will allow the Signatory CSD to monitor the Incident's status in the trouble management information tool.

Measurement is done based on the times recorded in the trouble management system.

4.1.3.2 Incident resolution time

Definition:

The Incident resolution time of an Incident is the time between the start of action to resolve the Incident and the time it is actually solved, or a workaround is available.

Measurement:

Upon acceptance of an Incident or service request the T2S service desk will assign a reference number and a priority level to it. The reference number will allow the Contracting CSD to monitor the Incident's status in the online trouble management information tool. Measurement is done based on the time of the start of the Incident as well as the time of its resolution as recorded in the Trouble Management System (TMS).

Unless the Contracting CSD formally objects promptly, both times above are the times recorded by the T2S service desk in the trouble management system.

T2S Framework Agreement

Schedule 6 – T2S Service Level Agreement

4.1.4 Business Continuity and Disaster Recovery

Objective:

The Business Continuity and Disaster Recovery mechanisms for T2S are designed to manage failures that require on-site recovery, alternate site recovery and alternate region recovery to ensure a high availability of the T2S Platform.

Business Continuity and Disaster Recovery scenarios will be categorised in the following classes:

Class	Description
Minor failure	Minor failure is understood as a short service interruption (e.g. due to component failures, a system reboot, or a line failure). These problems may typically be solved at the primary site.
Major failure	Major failure or disaster is understood as a serious service interruption (e.g. disruptions caused by fire, flood, terrorist attack or major hardware/ telecommunications faults). These events require the activation of the service in an alternative site.
Regional disaster	Regional disaster is understood as a "wide-scale regional disruption" causing severe permanent interruption of transportation, telecommunication, power or other critical infrastructure components across a metropolitan or geographical area and its adjacent communities; or resulting in a wide-scale evacuation or inaccessibility of the population within the normal commuting range of the disruption's origin. These events require the activation of the service in an alternative region.

4.1.4.1 Recovery time

Definition:

The recovery time (RTO = recovery time objective) is defined as the maximum acceptable time to restart the T2S Platform after a failure.

Measurement:

The recovery time is measured from the decision to failover due to an Incident that causes the unavailability of the T2S Platform as a whole (or significant parts of it) and the time the Incident is resolved, or a workaround is in place.

Where the agreed procedures foresee a consultation or decision of the Contracting CSD, the Participating CSDs and the Central Banks, the time between informing them and their response is excluded from the recovery time, as the time needed for reconciliation of lost data (see Incident handling in chapter 3.1).

T2S Framework Agreement

Schedule 6 – T2S Service Level Agreement

For the avoidance of doubt, activating the service in an alternative site (major failure) will preserve the status of instructions and transactions, both settled and non-settled. Within the constraints set by the recovery point objective (RPO) (see 4.1.4.2 below), this also applies to the re-activation of the service in an alternative region (regional disaster).

4.1.4.2 Recovery point objective

Definition:

The recovery point objective (RPO = recovery point objective) is defined as the maximum acceptable time interval for which data sent to and by T2S is lost when a restart takes place.

Measurement:

The recovery point is a point of consistency to which a User wants to recover or restart. The RPO is measured as the amount of time between the moment when the point of consistency was created or captured and that when the failure occurred.

4.2 Committed Service Levels for the Production Environment

4.2.1 Operational and Support Services

Response Times								
	Online Storage Period (4.1.2.7)	90 days						
	Archiving Period (4.1.2.6)	10 years						
	Archive Retrieval Response Time (4.1.2.7)	72 hours						
Availability								
	T2S Settlement Day	all calendar days except: Saturdays, Sundays, days where all the T2S settlement currencies are closed						
	Weighted Availability parameters (4.1.1.2)	<table border="1"> <thead> <tr> <th>Service</th> <th>Weight</th> </tr> </thead> <tbody> <tr> <td>A2A Connectivity</td> <td rowspan="3">As defined in the T2S Manual of Operational Procedures (T2S MOP)</td> </tr> <tr> <td>U2A Connectivity</td> </tr> <tr> <td>Lifecycle Management and Matching</td> </tr> </tbody> </table>	Service	Weight	A2A Connectivity	As defined in the T2S Manual of Operational Procedures (T2S MOP)	U2A Connectivity	Lifecycle Management and Matching
Service		Weight						
A2A Connectivity		As defined in the T2S Manual of Operational Procedures (T2S MOP)						
U2A Connectivity								
Lifecycle Management and Matching								

T2S Framework Agreement
Schedule 6 – T2S Service Level Agreement

		Settlement	
		Liquidity Management	
		Reference Data Management	
		Statistics, Queries, Reports, Archive	
		Operational Services	
	Weighted Availability value (4.1.1.2)	≥ 99.7 % / calendar month	
Support Hours and Incident Response Times			
	Standard Support Hours (4.1.3.1)	from 6:30 to 20:00 on all T2S Settlement Days except: 1 May	
	Non-Standard Support Hours (4.1.3.1)	All times on T2S Settlement Days which fall outside the Standard Support Hours	
	Incident Response Time (4.1.3.1)	15 min. during standard support hours 60 min. during non-standard support hours	

T2S Framework Agreement

Schedule 6 – T2S Service Level Agreement

Incident Resolution Time ⁹ (4.1.3.2)	Incident Priority	During standard support hours	Outside standard support hours
	1	2 hours	3 hours
	2	Before the start of the next Settlement Day (minimum 2 hours)	
	3	10 T2S Settlement days - subject to extension as agreed with requestor	
	4	Service Request or Queries ¹⁰	
Business Continuity and Disaster Recovery			
Recovery Time: minor failure (4.1.4.1)	See Incident Response/Resolution Time		
Recovery Point Objective: minor failure (4.1.4.2)	No data loss		
Recovery Time: major failure (4.1.4.1)	< 60 minutes (from the decision to failover to the 2 nd site in the same region)		
Recovery Point Objective: major failure (4.1.4.2)	No data loss		
Recovery Time: regional disaster (4.1.4.1)	< 120 minutes (from the decision to failover to the other region)		
Recovery Point Objective: regional disaster (4.1.4.2)	< 1 minute data loss		
Business Continuity Tests			
Intra-regional failover	To be tested once in six months		
Inter-regional failover	To be tested once in six months		

⁹ The KPI will apply to Incidents based on their Availability Impact. Refer to T2S MOP for the provisions on the resolution time of Incidents with a Data Integrity and/or Confidentiality as defined in the relevant Incident and Crisis Management procedures.

¹⁰ Refer to T2S MOP for Service Request Catalogue.

T2S Framework Agreement

Schedule 6 – T2S Service Level Agreement

Maintenance Windows		
	Start of weekly Maintenance Window ¹¹	Saturday (or the calendar day following the last T2S Settlement Day in a week) 02:30
	End of weekly Maintenance Window ¹²	Monday (or the first T2S Settlement Day in a week) 02:30
	Start of daily Maintenance Window if activated ¹³	3:00
	End of daily Maintenance Window if activated	5:00
Punctuality		
	Punctuality value	100% / calendar month
	Substantial delay (4.1.1.3) ¹⁴	10 minutes
	Duration of the IDVP cut-off	10 minutes
	Duration of the Start of Day Phase	75 minutes
	Duration of the Night time Settlement phase	210 minutes
	Duration of the End of Day phase	45 minutes
	Duration of the Penalty Mechanism daily processes	315 minutes
	Monthly Billing Process	Invoices to be sent on the 1 st Settlement day of the month by 12:00

4.2.2 Settlement Services and Liquidity Management Services

System Performance		
	Maximum Matching Time (4.1.1.6)	95% within 60 seconds 5% within 60 and 180 seconds

¹¹ The Eurosystem stands ready to occasionally change the scheduled time of the start of the weekly Maintenance Window based on its specific business needs (e.g. business continuity exercises). For further information please refer to the T2S MOP.

¹² The Eurosystem stands ready to occasionally change the scheduled time of the end of the weekly Maintenance Window based on specific needs of either the Contracting CSD (e.g. issuance in direct holding countries) or of the Eurosystem itself. For further information please refer to the T2S MOP.

¹³ The daily Maintenance Window is activated upon request of the T2S Operator. For further information please refer to the T2S MOP.

¹⁴ For event MAGG, the respect of the KPI will not be represented as a percentage, rather with "On time/Not on time".

T2S Framework Agreement

Schedule 6 – T2S Service Level Agreement

	Maximum Real-time Settlement Time (4.1.1.8)	95% within 90 seconds 5% within 90 and 270 seconds
--	--	---

System Capacity		
	Margin for exceptional peaks	20% of the T2S System Capacity (ceiling) for the Number of instructions received, the Daily number of reference data updates and Number of Securities Accounts (see chapter 6) 30 A2A queries per second (max 20.000 per hour)

4.2.3 Reference Data Services

Availability		
	Availability Period (4.1.1.1)	outside the Maintenance Windows on all T2S Settlement Days
	Reference Data Processing Time (4.1.1.9)	99% within 20 seconds 1% within 20 and 120 seconds

4.2.4 Information Services

Availability		
	Availability Period (4.1.1.1)	outside the Maintenance Windows on all T2S Settlement Days
Response Times		
	A2A Message Response Time (4.1.2.2)	99% within 20 seconds 1% within 20 and 270 seconds
	A2A Message in files Response Time (4.1.2.3)	99% within 60 seconds 1% within 360 seconds
	U2A Average Response Time (4.1.2.4)	3 seconds

T2S Framework Agreement

Schedule 6 – T2S Service Level Agreement

A2A Query Response Time for Simple Queries ¹⁵ (4.1.2.1)	95% within 20 seconds 5% within 20 and 120 seconds
A2A Query Response Time for Complex Queries (4.1.2.1)	95% within 5 minutes 5% within 5 and 15 minutes

4.2.5 Connectivity Services

System Performance	
Maximum Business Validation Time (4.1.1.5)	99% within 60 seconds 1% within 60 and 180 seconds
Technical Validation Time	99% within 20 seconds 1% between 20 and 60 seconds

4.3 Targeted Service Levels for the Production Environment

The more demanding, but non-binding target KPIs defined in this chapter reflect the Service Level, that is targeted by the Eurosystem. Even if these KPIs are not reached, but the Service Level is still within the range of the committed service levels (see chapter 4.2), this is no breach of the T2S Service Level Agreement. However, in such a case the Eurosystem stands ready to jointly investigate ways to improve the service.

4.3.1 Settlement Services and Liquidity Management Services

System Performance	
Maximum Matching Time (4.1.1.6)	99% within 60 seconds 1% within 60 and 180 seconds
Maximum Real-time Settlement Time (4.1.1.8)	99% within 90 seconds 1% within 90 and 270 seconds

¹⁵ The GFS (Version 4.0, page 582) defines the following queries as simple queries: Settlement Instruction Audit Trail Query, Securities Account Position Query, Securities Account Position History Query, T2S Dedicated Cash Account Balance Query, Outstanding Auto-Collateralisation Credit Query, Limit Utilisation Journal Query, Collateral Value of a Security Query, Securities Deviating Nominal Query, Securities CSD Link Query, Party List Query, Restricted Party Query, Securities Account List Query, T2S Dedicated Cash Account List Query, T2S Calendar Query, T2S Diary Query, System Entity Query, Attribute Domain Query, Attribute Value Query, Privilege Query, Role Query, T2S System User Query, Market-specific Restriction Query, SWIFT BIC Code Query, Report Configuration List Query, Report Configuration Detail Query, Report Query, Cumulative Invoice Query.

T2S Framework Agreement

Schedule 6 – T2S Service Level Agreement

4.3.2 Information Services

Response Times		
	A2A Query Response Time for Simple Queries (4.1.2.1)	99% within 20 seconds 1% within 20 and 120 seconds
	A2A Query Response Time for Complex Queries (4.1.2.1)	99% within 5 minutes 1% within 5 and 15 minutes

T2S Framework Agreement

Schedule 6 – T2S Service Level Agreement

5 Service Levels for the Test Environments

The non-binding target KPIs defined in this chapter reflect the Service Level, that is targeted by the Eurosystem for the test environments. Even if these KPIs are not reached there is no breach of the T2S Service Level Agreement. However, in such a case the Eurosystem stands ready to jointly investigate ways to improve the service.

5.1 Service Levels for the Pre-production environment¹⁶

5.1.1 Operational and Support Services

Support Hours	
Standard Support Hours (4.1.3.1)	07:00 – 19:30
Availability	
Availability Value (4.1.1.2)	95 % / calendar month
Availability Period (4.1.1.1)	From 7:00 to 19:00 on all calendar days except: Saturdays, Sundays, 1 January, Catholic/Protestant Easter Friday, Catholic/Protestant Easter Monday, 1 May, 25 December; 26 December or Days specified in the Pre-Production test environment calendar managed by the OMG.

5.2 Service Levels for the Interoperability test environment¹⁷

5.2.1 Operational and Support Services

Support Hours

¹⁶ Please see T2S Framework Agreement, Schedule 3 – User Testing.

¹⁷ Please see T2S Framework Agreement, Schedule 3 – User Testing.

T2S Framework Agreement

Schedule 6 – T2S Service Level Agreement

	Standard Support Hours (4.1.3.1)	07:00 – 19:30
Availability		
	Availability Value (4.1.1.2)	85% / calendar month
	Availability Period (4.1.1.1)	From 7:00 to 19:00 on all calendar days except: Saturdays, Sundays, 1 January, Catholic/Protestant Easter Friday, Catholic/Protestant Easter Monday, 1 May, 25 December; 26 December or Days specified in the Interoperability test environment calendar managed by the PMG.

5.3 Additional provisions

The test environment can be opened with extended hours for a limited period upon request. The Eurosystem will make all reasonable efforts to ensure that the operational hours of the test environments, including on-line availability for end-users and batch processing capabilities for the end of day procedures will be specified in the T2S User Testing Calendar and might be different for each of the testing environments. In certain cases, such as the deployment of a new release, the Eurosystem reserves the right to change the T2S User Testing Calendar, which includes changing the opening and closing times of the test environments. All changes to the T2S User Testing Calendar shall be proposed, discussed, and agreed in the substructure in charge of User Testing, before informing the T2S Users in a timely manner in advance.

The Cyber Resilience and Information Security levels of the test environments shall be broadly the same as for the T2S production environment.

Regarding the capacity of the test environments, i.e. pre-production and interoperability environments, they normally have jointly a capacity that is substantially lower compared to the

T2S Framework Agreement

Schedule 6 – T2S Service Level Agreement

production environment (10%¹⁸ of the long-term capacity model for the system capacity ceiling of the production environment¹⁹) that, if needed, can be increased to reach the production levels.

The Eurosystem shall increase the capacity of the test environments to cover specific testing needs (e.g. high-volume tests during the community testing and the business day testing stages) upon a request from – and in agreement with – the Contracting CSD.

The interoperability environment has allocated twenty-five calendar days²⁰ per year of production-like capacity²¹ to support high-volume test activities, such as migration and volume testing for the Contracting CSD and Participating CSDs as well as stress/performance testing and volume testing requested by the T2S Actors.

The T2S Service desk shall be the single point of contact to report incidents and problems, and to ask for guidance on T2S during User Testing. The Contracting CSD can contact the T2S Service desk via phone, and email.

The T2S Service desk coverage hours shall be aligned to the operation hours of the test environment referred to above.

¹⁸ 10% is to be intended as the capacity of the two test environments combined.

¹⁹ This does not apply to the number of Securities Accounts. In case of direct-holding markets, the respective CSD will agree with the T2S Operator on the number of SACs to be configured in test environments, taking into consideration the test environments capacity.

²⁰ In case more days are required, the T2S Operator will provide them at no additional cost. The number of days allocated would be re-evaluated on a regular basis, based on the testing needs.

²¹ Days when the full set of CPU processors is made available as in production.

T2S Framework Agreement

Schedule 6 – T2S Service Level Agreement

6 System Capacity and Platform Sizing

In order to ensure the proper sizing of the T2S Platform that is required to meet the agreed Service Levels, the Eurosystem provides the Contracting CSD with historical data on a quarterly basis, for the previous four quarters, according to the indicators in the table below. The Contracting CSD is then requested to provide updated forecasts for the next four quarters for average business figures as specified below, to allow the Eurosystem to make an adequate long-term capacity planning. The figures of the historical data provided by the Eurosystem and of the forecasts provided by the Contracting CSD should include the volumes for the Contracting CSD's DCPs as well. Forecasts are produced in good faith, on a best effort basis by the Contracting CSD and translated by the Eurosystem into metrics that are relevant for estimating the T2S system capacity (ceiling)²². The SLA commitment is based on this estimation.

The following parameters are required for these calculations:

Parameter	Description
1. Number of instructions received	Quarterly average daily distribution of incoming instructions (in a breakdown for SoD, NTS, RTS and EoD) ²³ . Historical data (average, minimum and maximum) for previous 4 quarters is provided by the Eurosystem and forecasts (average) are then provided by the Contracting CSD for the upcoming quarters.
2. Daily number of reference data updates	The historical and expected number of A2A insertions, modifications, and deletions of Securities Reference Data to be executed in T2S on one day. The historical data (average, minimum and maximum) for previous 4 quarters is provided by the Eurosystem and forecasts (average) are provided by the Contracting CSD.
3. Daily average of A2A queries	Previous 4 quarters' minimum, maximum, and average daily number of A2A queries is provided by the Eurosystem and forecasts (average) as foreseen for the next 4 quarters are provided by Contracting CSD.
4. Number of Securities Accounts	Total number of securities accounts (at the close of the reporting period), in the previous 4 quarters is provided by the Eurosystem and forecasts (average) as foreseen for the next 4 quarters are provided by the Contracting CSD.

²² The system's capacity ceilings are described in the T2S MOP.

²³ Abbreviations: SoD = Start of Day Phase; NTS = Night Time Settlement Phase; RTS = Real Time Settlement Phase; EoD = End of Day Phase.

T2S Framework Agreement

Schedule 6 – T2S Service Level Agreement

In order to process exceptionally high peak volumes, the Eurosystem will ensure that additional processing capacity can be added on very short notice, provided no hardware components need to be replaced. However, there will be technical limitations to the extent of such a capacity increase.

If the expectations change, the Contracting CSD will inform the Eurosystem.

If exceptional capacity is needed for a one-time event or on shorter notice, the Eurosystem will try to cope with such requests, but on best effort basis only.

T2S Framework Agreement

Schedule 6 – T2S Service Level Agreement

7 Service Level Reporting

Monthly reports including local service desk operations will be provided on a regular basis in electronic format, focusing on the above defined service metrics.

7.1 Content of the Reporting

Performance against Service Level targets will be measured by the Eurosystem in compliance with the procedures agreed between the Parties.

Reports on actual Service Levels achieved will be provided to the Contracting CSD monthly. This will cover for each service indicator the performance achieved compared with the committed values. For informational purposes the Eurosystem will also report the bilateral service levels achieved for the Contracting CSD. These reports are to be provided to the Contracting CSD within ten Settlement Days after the end of each month.

On a daily basis and reflected in the monthly SLA report:

- Actual service (including security) breaches
- Planned downtime
- Unplanned downtime
- Service availability²⁴

On a monthly basis:

- Frequency of incidents
- Cumulative service breaches
- Use of T2S service desk (when relevant)
- Application and technology performance specified in this document (i.e. input/output file throughput, statistics on incoming/outgoing messages)
- Planned changes
- Previous month's unresolved incidents
- Previous month's resolved incidents
- Previous month's unresolved problems
- Previous month's resolved problems
- Comments and observations from the Eurosystem
- Medium term trends of incident and their root cause analysis

²⁴ The Availability will be featured in the monthly report with a daily breakdown, whereas the calculation for the purpose of the KPI will remain on a monthly basis.

T2S Framework Agreement

Schedule 6 – T2S Service Level Agreement

- Support figures (e.g. number of calls, response time, long abandon rate)
- Volume and capacity estimations as per the Long-Term Capacity Planning provisions (see T2S MOP) for Production and Pre-production environments

The SLA report will additionally feature a set of indicators for the test environments as defined in chapters 5.1 and 5.2.

The Monthly report is also composed of the following Annexes:

- LTCP Peaks Annex: it is prepared and enclosed to the Monthly report when, in a specific month, a daily peak, vis-à-vis the defined and agreed daily ceilings, is observed.
- UTEST availability incidents: it reports the concrete start and resolution times of the critical and urgent incidents (severity 1 and 2) occurred in UTEST that have an overall impact on Availability, both U2A and A2A.

7.2 Definition of Additional Indicators for Reporting

This chapter defines additional indicators that are used for the reporting but have no KPI attached to it.

7.2.1 File throughput

Definition:

The file throughput is defined as the minimum number of megabytes per hour that the interface subsystem has to be able to process in one hour independently for input and output.

Measurement:

The file throughput is measured by summing up the size of all files received during the reporting period and dividing this value by the actual processing time needed. The processing time is measured using the timestamps generated by the T2S network interface and as part of the T2S audit trail

7.2.2 Batch Settlement throughput

Definition:

The Batch Settlement throughput is the ratio of the number of settlement instructions processed and the time that elapsed for processing them (i.e. between the start and end of the processing cycles). All instructions that are ready for settlement are considered regardless of whether they have been settled or not.

Measurement:

The Batch Settlement throughput is measured based on timestamps stored as part of the audit trail in the T2S database.

T2S Framework Agreement

Schedule 6 – T2S Service Level Agreement

Calculation:

$$R_n = \frac{I_n}{T_n}$$

Where:

Rn = Batch Settlement throughput

In = number of settlement instructions processed in Batch Settlement mode

Tn = cumulated Batch Settlement processing time

7.3 T2S Operations report

The Eurosystem will complement the Service Level report with the T2S Operations report. The aim of the report is to provide information on operational activities, settlement statistics and follow up of Service Level monitoring. The report is prepared on a monthly basis by the Eurosystem and shared with the Operations Managers Group and the T2S Steering Level.

T2S Framework Agreement

Schedule 6 – T2S Service Level Agreement

8 Monthly Service review meetings

The Eurosystem and the Contracting CSD will review the T2S service performance commitments during their regular meetings at T2S Steering Level. In addition, the Eurosystem will convene on a monthly basis or upon request a meeting of the Operations Managers Group (OMG) to review the T2S service performance on a working level.

This meeting will evaluate the service performance since the last review. In particular the meeting will:

- Review the service achievement (service level target against actual performance)
- Review the Service Level Reports provided in recent periods. However, for the sake of intra-annual comparability, the Service Level Report format might be changed only on a yearly basis.
- Focus particularly on breaches of Service Levels
- Identify weak areas and potential ways to address problems and initiate service improvement
- Preview issues (anticipated measures) for the coming period.

T2S Framework Agreement

Schedule 6 – T2S Service Level Agreement

9 Annual SLA reviews

The Parties agree that the SLA will be reviewed on a yearly basis in order to verify the balance between evolving User requirements and defined T2S Service Levels, as well as to ensure the effectiveness of performance measuring criteria.

If required by the circumstances, the SLA can be reviewed on an ad-hoc basis.

Agreement review meetings provide an opportunity to review the agreement and associated targets. In particular the meeting will:

- Review service achievements with the customer and identifying potential improvement on both sides
- Review the service requirements and identify if any changes have occurred
- Discuss any changes that operations would like to make to the agreement
- Agree on the next step for the SLA: extension, changes or decommissioning.

Changes to the SLA will be agreed in accordance with the applicable governance arrangements specified in Schedule 8 (Governance) of the T2S Framework Agreement, in particular through the involvement of the Operations Managers Group.

All resulting changes to this SLA shall be approved by the Parties. In case of persistent disagreement between the Parties, the dispute resolution procedure laid down in the T2S Framework Agreement shall be activated.

SCHEDULE 6 - ANNEX 1

MANAGEMENT OF NON-FUNCTIONAL CHANGES

T2S Framework Agreement

Schedule 6 – T2S Service Level Agreement

Annex 1 - Management of non-functional changes

1. Emergency Changes

If an Incident occurs, the Eurosystem may have to implement a change that cannot be delayed until the next planned Maintenance Window. The implementation of such a change will cause a system unavailability.

As a minimum, the Eurosystem will inform the Contracting CSD ex post about the reason for and the nature of the change. Nevertheless, the Eurosystem will make best efforts to inform the Contracting CSD ex ante, even at short notice.

2. Other changes

By default, changes aimed at ensuring that the Eurosystem is capable of delivering the T2S Services according to the KPIs specified in this SLA or resulting from SLA reviews (see section 9), will be managed by the Eurosystem. If such changes have no impact on the Contracting CSD, the Eurosystem will inform the Contracting CSD ex ante about the nature and the date of such change.

If such changes have an impact on the Contracting CSD, or if the Contracting CSD expresses an interest in testing such changes, the Eurosystem and the Contracting CSD will co-operate in good faith to manage the changes, as much as possible and where relevant, following the provisions of Schedule 9 (Change and Release Management).

The dates reserved by the Eurosystem for implementing changes that have or might have an impact on the Contracting CSD, are documented in a calendar that is shared and agreed in advance with the Contracting CSD. Changes to this calendar will be reported in the monthly reporting as described in section 7. By default, changes are implemented during a Maintenance Window.

The Contracting CSD is responsible to involve its DCPs in the process if necessary and share the relevant information with them.



EUROPEAN CENTRAL BANK

EUROSYSTEM

T2S FRAMEWORK AGREEMENT

SCHEDULE 7

PRICING

T2S Framework Agreement

Schedule 7 – Pricing

Table of contents

1	Introduction	3
2	T2S pricing policy	4
3	T2S price list	5
3.1	MINIMUM THRESHOLD FOR PRODUCTION OF MANUAL INVOICES	6
3.2	MINIMUM BILLING AMOUNT	6
4	T2S pricing structure	7
4.1	SUMMARY	7
4.2	SETTLEMENT SERVICES	8
4.3	INFORMATION SERVICES	16
4.4	TARIFF ITEMS INITIALLY PRICED AT ZERO	20
4.5	TARIFF ITEMS PRICED AT ZERO AT LEAST UNTIL END OF COST-RECOVERY PERIOD	23
5	Inventory of T2S service charges	24
5.1	INTRODUCTION	24
5.2	CHANGES	24
5.2.1	T2S Common Changes	24
5.2.2	T2S Specific Changes	25
5.2.3	Pricing of assessments of Change Requests	25
5.3	RTGS FEES FOR CONNECTING TO T2S	26
5.4	TRAINING	26
5.5	CONSULTANCY	26
5.6	REQUEST FOR AN ADDITIONAL TEST ENVIRONMENT.....	27
5.7	SECURITIES REFERENCE DATA	27
5.8	CONDITIONAL PARTICIPATION FEE AND ONE-OFF JOINING FEE.....	27
5.9	EXIT MANAGEMENT	27
5.10	EXTERNAL EXAMINER	27
5.11	REIMBURSEMENTS OF COSTS FOR STORING DATA.....	28

Annex 1: List of Reports and Queries and business items

1 Introduction

The Schedule on Pricing consists of four components: (i) the T2S Pricing policy, which describes the Governing Council decision on the Pricing of T2S Services (ii) the T2S price list, which gives the actual T2S prices in eurocent for each of the T2S Services (i.e. settlement, account management and information services); (iii) the T2S pricing structure, which provides a detailed description of the items in the T2S price list, as well as the related fee triggers; and (iv) the Inventory of T2S service charges, which provides a description of how T2S will finance changes to T2S, and a number of other services not covered in the T2S price list.

All prices are displayed on the T2S price list without VAT, which is not applied to T2S Services.

The procedures for the exercise, allocation and payment of claims under Articles 21, 28, 32, 33 and 40 of the T2S Framework Agreement are detailed in Schedule 13 (Procedure for Payment of Claims).

Following the establishment of the T2S pricing policy in 2010, the Eurosystem revised the pricing levels in 2018, seeking broad market advice. It will continue to do so when discussing possible changes to the Pricing Schedule.

2 T2S pricing policy

The Governing Council of the European Central Bank (ECB) decided to set the Delivery versus Payment price for TARGET2-Securities (T2S) at 15 eurocent per instruction. This price was fixed for the period from the T2S Go-Live Date (22 June 2015) until December 2018.

The commitment to set the price at 15 eurocent was subject to the following conditions: (i) non-euro currencies add at least 20% to the euro settlement volume; (ii) the securities settlement volume in the EU is no more than 10% lower than the volumes projected by the T2S Programme Office, which are based on market advice; and (iii) tax authorities confirm that the Eurosystem will not be charged VAT for the T2S Services it provides.

In 2018, the Governing Council revised the pricing policy of T2S in the light of the start of operations in June 2015, and of the end of the Migration Period in September 2017. In doing so, it agreed new baselines for the T2S Pricing with the market representatives, to continue pursuing full cost recovery, whilst maintaining the pricing structure unchanged, in terms of the different weights for the tariff items.

The price list in Section 2 reflects the pricing level agreed within the updated baselines, consisting in a basis DvP of 19.5 eurocent with an additional 4-eurocent surcharge linked to the perspective volumes developments. The resulting figure of 23.5 eurocent remains the basis for the pricing structure.

T2S Framework Agreement

Schedule 7 – Pricing

3 T2S price list

<i>Tariff items</i>	<i>Price (eurocent)</i>	<i>Explanation</i>
Settlement services		
Delivery versus Payment	23.5	per instruction [†]
Free of Payment	14.1	per instruction [†]
Payment Free of Delivery	14.1	per instruction [†]
Internal T2S liquidity transfer	14.1	per transfer
Account allocation	4.7	per instruction [†]
Matching	4.7	per instruction [†]
Intra-position movement	9.4	per transaction
Intra-balance movement	9.4	per transaction
Auto-collateralisation service with Payment Bank	23.5	for issue and return, charged to collateral provider ^{††}
Intended Settlement Date failed transaction	23.5	surcharge per Settlement Day failed per instruction [†]
Daytime settlement process	4.7	surcharge per instruction [†]
Daytime congestion charge	0 *	additional surcharge per instruction [†]
Auto-collateralisation service with Central Bank	0 *	for issue and return, charged to the collateral provider
Instruction marked with 'top or high priority'	0 *	surcharge per instruction [†]
Cancellation	0 *	per instruction [†]
Settlement modification	0 *	per instruction [†]
Information services		
A2A reports	0.4	Per business item in any A2A report generated
A2A queries	0.7	Per queried business item in any A2A query generated
U2A queries	10	Per executed search function
Messages bundled into a file	0.4	Per message in a file
Transmissions	1.2 **	Per transmission
Account management services		
Securities Account	Free of charge ***	Fee options: a) monthly fee per ISIN in the account <u>or</u> b) monthly fee per account
Fee per T2S Dedicated Cash Account	0 ****	Monthly

[†] A transaction consists of two instructions.

^{††} The auto-collateralisation with Payment Bank (i.e. client-collateralisation) is charged in line with the usage of T2S resources; only the collateral provider is charged. One collateralisation item plus both instructions of each auto-collateralisation leg are charged per ISIN and providing account, i.e. X cents * 5 (i.e. 1 collateralisation item + 4 settlement instruction) for each auto-collateralisation service with Payment Bank, where X is the price of settlement instructions and collateralisation items.

* T2S is sized in accordance with an expected consumption pattern, i.e. the anticipated distribution of settlement volumes during night-/day-time and peak hours. These items were initially be set at a zero price, presuming that actual usage of T2S would remain within this expected consumption pattern over time. However, should there be a stronger than expected use of T2S resources and the volume distribution pattern be different than expected thus adversely affecting T2S performance, it will be reconsidered to charge for these items. The Eurosystem regularly reviews the actual volumes against expected patterns for the different items.

** Transmissions for 'ECMS Statement of Holdings', 'ECMS Statement of Transactions' and 'ECMS Statement of Pending Instructions' are not charged.

*** Account management services for Securities Accounts are set at zero and will not be changed until the end of the Cost Recovery Period, at least.

**** Account management services for T2S Dedicated Cash Accounts (DCAs) are not charged, presuming that the actual number and usage of DCAs will remain within expected consumption patterns. However, should DCAs involve a stronger than expected use of T2S resources thus adversely affecting T2S performance, it will be reconsidered to charge for these items. The Eurosystem regularly reviews the matter together with the Central Banks operating the DCAs.

3.1 Minimum threshold for production of manual invoices

The minimum threshold for production of manual invoices and manual adjustments shall be as follows:

- (1) Below the threshold of EUR 150 neither manual invoices nor corrective credit or debit notes shall be issued.
- (2) The threshold laid down in point (1) shall apply individually to each manual invoice and each corrective credit or debit note prior to its issuance.
- (3) The threshold laid down in point (1) shall only apply to the production of manual billing documents. Billing data are generated regardless of the monthly total that would be invoiced.
- (4) The production of automatic invoices, which generate the billing data according to the actual consumption of T2S Services, shall not be affected by the introduction of the threshold laid down in point (1).

3.2 Minimum billing amount

The minimum billing amount shall be as follows:

- (1) If the net due amount for the Contracting CSD for any given month is below EUR 150, the Contracting CSD shall pay a minimum billing amount of EUR 150 regardless of the T2S traffic generated in said month. The net due amount shall be calculated on the basis of the amount of the automatic invoice, as corrected by any manual adjustments issued, in accordance with the previous point (1), in the form of manual invoices or corrective credit or debit notes.
- (2) Invoicing documentation (automatic and manual) shall include wording specifying that if the net due amount is less than EUR 150, then the Contracting CSD is requested to pay the minimum amount of EUR 150 for the monthly billing period in question.
- (3) If the net due amount as defined in point (1) is equal to or higher than EUR 150, the Contracting CSD is not subject to a minimum billing amount but shall pay the net due amount.

T2S Framework Agreement

Schedule 7 – Pricing

4 T2S pricing structure

4.1 Summary

<i>Tariff items</i>	<i>DvP weight factor</i>	<i>Explanation</i>
Settlement services		
Delivery versus Payment	100%	per instruction
Free of Payment	60%	per instruction
Payment Free of Delivery	60%	per instruction
Internal T2S liquidity transfer	60%	per transfer
Account allocation	20%	per instruction
Matching	20%	per instruction
Intra-position movement	40%	per transaction
Intra-balance movement	40%	per transaction
Auto-collateralisation service with Payment Bank	100%	for issue and return, charged to collateral provider
Intended Settlement Date failed transaction	100%	surcharge per Settlement Day failed per instruction
Daytime settlement process	20%	surcharge per instruction
Daytime congestion charge	0%	additional surcharge per instruction
Auto-collateralisation service with Central Bank	0%	for issue and return, charged to the collateral provider
Instruction marked with 'top or high priority'	0%	surcharge per instruction
Cancellation	0%	per instruction
Settlement modification	0%	per instruction
Information services		
A2A reports	n/a	Per business item in any A2A report generated
A2A queries		Per queried business item in any A2A query generated
U2A queries		Per executed search function
Messages bundled into a file		Per message in a file
Transmissions		Per transmission
Account management services		
Securities Account	Free of charge	Fee options: a) monthly fee per ISIN in the account <u>or</u> b) monthly fee per account
Fee per T2S Dedicated Cash Account	0%	Monthly

4.2 Settlement services

The general principle is that each completed settlement service activity is counted and reflected in the relevant monthly bill. Unless indicated otherwise, billable events are charged based on the date in which T2S successfully executes the related instructions/the events occur.

Two counterparties to a settlement transaction initiate one instruction each and the two instructions are then matched and form one transaction.

The T2S Pricing structure aims at charging for resource usage in most instances. The price for settlement services is set relative to a DvP settlement.

Each partial settlement¹ is charged separately (e.g. a settlement instruction settled in three parts is charged the DvP or FoP price three times, and any of the parts settled in the period 07:00 – 18:00 will attract the daytime surcharge).

Conditional securities delivery² transactions are charged according to their individual components, e.g. DvP or FoP, Matching, blocking and unblocking, creation of a condition and release of a condition, i.e. hold and release.

Section 4.4 contains the list of items which are initially set at a zero price, presuming that actual usage of T2S will be within the expected anticipated distribution of settlement volumes during night-/day-time and peak hours.

Section 4.5 contains the list of items which are priced at zero and will not be charged until the end of the Cost Recovery Period, at least.

¹ Partial settlement is defined in the URD as “a process that settles only a fraction of settlement instructions original volume and amount when full settlement is not possible due to lack of securities. The residual unsettled volume and amount may settle at a later stage during the Intended Settlement Date. Any residual amount at the end of the intended settlement date results in the reporting of a failed settlement”.

² Conditional securities delivery is defined in the URD as “a procedure in which the final securities and/or cash booking is dependent on the successful completion of an additional action or event (e.g. registration of shares, cash settlement outside T2S)”.

T2S Framework Agreement

Schedule 7 – Pricing

Delivery versus Payment

Price	Eurocent 23.5 per instruction
DvP weight factor	<i>100% (the numeraire)</i>
Background	<i>The DvP requests a simultaneous transfer of securities versus cash. Both instructing parties are charged. The DvP price constitutes the numeraire for other instruction related charges (i.e. other instruction charges are indicated as a percentage of the DvP price). Realignment instructions resulting from a DvP are not charged.</i>
Fee trigger	<i>Each successfully completed DvP settlement.</i>

Free of Payment

Price	Eurocent 14.1 per instruction
DvP weight factor	<i>60%</i>
Background	<i>The FoP requests a transfer of securities only. There is no cash processing required. Both parties to the FoP are charged. Realignment instructions resulting from a FoP are not charged.</i>
Fee trigger	<i>Each successfully completed FoP settlement.</i>

Payment Free of Delivery

Price	Eurocent 14.1 per instruction
DvP weight factor	<i>60%</i>
Background	<i>The PFOD requests a transfer of cash only. There is no securities processing required. Both parties to the PFOD are charged. Realignment instructions resulting from a PFOD are not charged.</i>
Fee trigger	<i>Each successfully completed PFOD settlement.</i>

T2S Framework Agreement

Schedule 7 – Pricing

Internal T2S liquidity transfer

Price	Eurocent 14.1 per transfer
DvP weight factor	60%
Background	<p><i>Internal liquidity transfers between two T2S Dedicated Cash Accounts are charged with a DvP weight factor of 60%.</i></p> <p><i>Liquidity transfer charges are invoiced to T2S Users via the T2S Users' Central Bank.</i></p> <p><i>Payments triggered as part of a DvP are included within the DvP instruction charge.</i></p>
Fee trigger	<p><i>All successfully executed liquidity transfers between two T2S Dedicated Cash Accounts.</i></p> <p><i>The fee is charged to the instructing party, i.e. the debited party.</i></p>

Account allocation

Price	Eurocent 4.7 per instruction
DvP weight factor	20%
Background	<p><i>An account allocation in a “direct holding market” is an instruction involving at least one Securities Account which has been flagged as an “end-investor account” in T2S. Two instructions per transaction are charged. If the account allocation instructions are sent unmatched, the Matching fee is charged in addition. The definitions of a “direct holding market” and “end-investor account” in the context of the T2S Pricing Schedule are provided below.</i></p> <p><i>For the purpose of T2S Pricing, a “direct holding market” is defined as a market:</i></p> <ol style="list-style-type: none"> <i>1. in which, at a minimum, for holdings of domestic securities generally held by domestic residents, end-investors (retail investors in particular) would generally have an account directly in the Issuer CSD; and</i> <i>2. which brings all segregated end-investor accounts to T2S that contain securities that are available in T2S.</i>

For the purpose of T2S Pricing, the following markets are considered as direct holding markets according to paragraph 1: Cyprus, Denmark, Estonia, Finland, Greece, Iceland, Malta, Norway, Romania, Slovakia, Slovenia, Sweden. This list is subject to review by the T2S Governance bodies when needed, following the procedure for ‘Decision-making on relevant matters other than Change Requests’ in Schedule 8 (Governance).

Definition of “end-investor accounts” and instructions eligible for the reduced account allocation fee

For the purpose of T2S Pricing, there are two options which a Signatory CSD serving a direct holding market in T2S can choose with respect to the definition of “end investor accounts and the instructions which are eligible for the account allocation fee:

Option A for a direct holding market in T2S:

- a. All segregated accounts of customers of Signatory CSDs are eligible to be flagged as ‘end-investor account eligible for the account allocation fee’. It is the responsibility of the respective Signatory CSD in a direct holding market in T2S in cooperation with its participants to ensure a proper flagging of accounts.*
- b. FoP instructions involving at least one account flagged as ‘end-investor account eligible for the account allocation fee’ are charged the account allocation fee, which is applicable to both sides of the FoP transaction.*

Or:

Option B for a direct holding market in T2S:

- a. All retail investor accounts are eligible to be flagged as ‘end-investor account eligible for the account allocation fee’. A retail investor means a ‘retail client’ in the meaning of MiFID II (OJ L 173 12.6.2014). It is the responsibility of the respective Signatory CSD in a direct holding market in T2S*

T2S Framework Agreement
Schedule 7 – Pricing

	<p><i>in cooperation with its participants to ensure a proper flagging of accounts.</i></p> <p><i>b. DvP and FoP instructions involving at least one account flagged as ‘end-investor account eligible for the account allocation fee’ are charged the account allocation fee, which is applicable to both sides of the transaction.</i></p> <p>The following principles apply to account allocations:</p> <ol style="list-style-type: none"> <i>1. The objective of the fee for account allocations is to ensure a level playing field in T2S between direct and indirect holding markets.</i> <i>2. As a principle, the account allocation fee should not be used for transactions in direct holding markets in T2S that would have been charged the full price in an average indirect holding market or in an average direct holding market opting for a layered model in T2S.</i> <i>3. In line with the transparency principle of T2S, the T2S Board reports on an annual basis about the share of DvP transactions, FoP transactions and Account allocations in each of the respective direct holding markets in T2S. This report includes the share of DvP transactions and FoP transactions of the aggregated indirect holding markets in T2S for comparison.</i>
<p>Fee trigger</p>	<p><i>The fee trigger depends on which option A or B is chosen by the respective Signatory CSD serving a direct holding market in T2S:</i></p> <ul style="list-style-type: none"> <i>• Option A. Any FoP instruction involving at least one account flagged as ‘end-investor account eligible for the account allocation fee’ is charged the account allocation fee, which is applicable to both sides of the FoP transaction.</i> <p><i>Or:</i></p> <ul style="list-style-type: none"> <i>• Option B. Any DvP or FoP instruction involving at least one account flagged as ‘end-investor account eligible for the account allocation fee’ is charged the account allocation fee, which is applicable to both sides of the transaction.</i>

Matching

T2S Framework Agreement

Schedule 7 – Pricing

Price	Eurocent 4.7 per instruction
DvP weight factor	20%
Background	<p><i>An unmatched instruction will have to pass through the Matching process and will assume additional processing resources of T2S. Therefore, it attracts a standard Matching charge on top of the regular settlement instruction fee.</i></p> <p><i>The Matching charge is 20% of a DvP instruction charge and is applied to both parties.</i></p>
Fee trigger	<i>Each successfully completed Matching event.</i>

Intra-position movements

Price	Eurocent 9.4 per transaction
DvP weight factor	40%
Background	<p><i>All intra-position movements in the case of securities (i.e. blocking/ unblocking/ reservation/ unreservation/ earmarking / unearmarking) attract an instruction-based fee. Internally generated intra-position movements are also charged.</i></p> <p><i>For example, say a securities position is blocked for a specific DvP transaction. Once the DvP transaction which is using the blocked securities is ready to be settled, T2S will first have to unblock the securities position so the DvP can settle. This unblocking is charged. Examples are available in the UDFS.</i></p> <p><i>No fees are applied for the blocking of reference data (i.e. of the T2S Actor, Securities Account). The intra-position movement fee is charged to respective T2S Users via their Signatory CSD.</i></p>
Fee trigger	<i>Any successfully executed intra-position movement.</i>

T2S Framework Agreement

Schedule 7 – Pricing

Intra-balance movements

Price	Eurocent 9.4 per transaction
DvP weight factor	40%
Background	<p><i>All intra-balance movements in the case of cash (i.e. blocking/unblocking) attract an instruction-based fee. Internally generated intra-balance movements are also charged. The fees are also applied for the automatic release of cash blockings during end-of-day and the regenerated cash blockings at the next start-of-day in the case of a Conditional Securities Delivery (CoSD).</i></p> <p><i>No fees are applied for the blocking of reference data (i.e. of the T2S Actor, Securities Account). The intra-balance (cash) movement fee are charged to respective T2S Users via their Central Bank.</i></p>
Fee trigger	<i>Any successfully executed intra-balance movement.</i>

Auto collateralisation service with Payment Bank

Price	Eurocent 23.5 per transaction
DvP weight factor	100%
Background	<p><i>The complete auto-collateralisation with a Payment Bank attracts an all-in-one fee of 100% DvP weight factor for issue and return: one collateralisation item plus both instructions of each auto-collateralisation leg are charged per ISIN and providing account. Only the collateral provider is charged.</i></p>
Fee trigger	<i>Each successfully executed auto-collateralisation transaction with a Payment Bank within the monthly billing period.</i>

Fail on Intended Settlement Date

Price	Eurocent 23.5 per instruction
DvP weight factor	100%
Background	<p><i>Matched settlement instructions failing to settle on their Intended Settlement Date (ISD) are re-introduced into all the future settlement cycles until they either settle or are cancelled by the two counterparties.</i></p> <p><i>The <u>daily charge</u> addresses the resource cost of congestion and of the</i></p>

T2S Framework Agreement

Schedule 7 – Pricing

	<i>additional processes required to recycle a failed transaction, e.g. eligibility checking. Disciplinary actions are not applied by T2S through its price list. Both parties of the failing settlement transaction will attract the charge.</i>
Fee trigger	<i>Each Matched DvP, FoP, or PFOD which does not settle on its Intended Settlement Date attracts a surcharge. Furthermore, the surcharge is applied for every Settlement Day that the instruction fails to settle after the ISD. The charge is applied to both parties of the transaction.</i>

Daytime settlement process

Price	Eurocent 4.7 <u>surcharge</u> per instruction settled during the period 07:00 - 18:00
DvP weight factor	<i>20%</i>
Background	<i>Settlement instructions successfully executed during the period 07:00 – 18:00 attract a 20% “daytime surcharge”.</i>
Fee trigger	<i>Any DvP, FoP or PFOD instruction successfully settled during the period 07:00 – 18:00 attract the daytime surcharge.</i>

4.3 Information services

Reports, queries and messages of Directly Connected Parties (which are entitled to do so by the respective Signatory CSD) are charged to the Signatory CSD of the Directly Connected Party. Reports, queries, and messages of a Payment Bank are charged to the Central Bank of the Payment Bank. Reports, queries, and messages that are received/generated during peak hours, i.e. the last two hours prior to the DvP cut-off time (i.e. indicatively between 2 p.m. – 4 p.m.), may be subject to the daytime congestion surcharge.

For the purposes of the Pricing of information services, the following definitions are used:

- A '**business item**' is one instance of a business entity defined in the T2S data model (e.g. settlement instruction, securities position, intra-balance movement, liquidity transfer, cash posting, Securities Account, Dedicated Cash Account etc.) with all its attributes.
- A '**message**' is an encrypted inbound/outbound communication used for Application-to-Application (A2A) interactions between T2S and its participants. A complete list of all messages is available in Chapter 3 of the User Detailed Functional Specifications (UDFS).
- A '**file**' is a structured collection of 'messages'.
- A '**transmission**' can be any of the following: a 'message', a 'file', an 'A2A query request', 'A2A query response' or an 'A2A report'.

A2A reports

Price	Eurocent 0.4 per business item in an A2A report
Background	<i>A2A reports are charged based on the reported number of business items. The list of A2A reports and associated business item is included in Annex 1 to Schedule 7.</i>
Fee trigger	<i>Any A2A report generated, with the charge based on the reported number of business items.</i>

A2A queries

Price	Eurocent 0.7 per queried business item in an A2A query
Background	<i>A2A queries are charged based on the number of queried business items. The list of A2A queries and associated business item is available in Annex 1 to Schedule 7.</i>

T2S Framework Agreement

Schedule 7 – Pricing

Fee trigger	<i>Any A2A query generated, with the charge based on the number of queried business items.</i>
--------------------	--

U2A queries

Price	Eurocent 10 per executed U2A query
Background	<p><i>U2A queries are submitted via the GUI and the U2A query response is received by the GUI. U2A queries viewed on the GUI are charged a fixed fee per executed query.</i></p> <p><i>If a U2A query were downloaded/exported, then it is charged in the same manner as for A2A queries (i.e. per business item in the downloaded U2A query). The list of U2A queries and associated business item is available in Annex 1 to Schedule 7.</i></p>
Fee trigger	<p><i>Any executed U2A search function viewed on the GUI is charged a fixed fee.</i></p> <p><i>If a U2A query is downloaded, it is additionally charged in the same manner as for A2A queries (i.e. per queried business item).</i></p>

Messages bundled into a file

Price	Eurocent 0.4 per message in each file containing bundled messages
Background	<p><i>T2S Actors have the possibility to send messages to T2S and receive messages from T2S bundled together into a file.</i></p> <p><i>Messages received by T2S which are not accepted or not successfully authenticated are not charged for.</i></p>
Fee trigger	<i>Each file containing bundled messages, with the charge based on the number of messages in the file.</i>

Transmissions

Price	Eurocent 1.2 per transmission
Background	<i>All types of transmissions (with the exception of technical acknowledgement messages, ECMS Statement of Holdings, ECMS Statement of Transactions and ECMS Statement of Pending Instructions) are counted and charged for.</i>

T2S Framework Agreement

Schedule 7 – Pricing

Fee trigger	<i>Each transmission per T2S Party (both inbound and outbound) is counted and charged for (except for technical acknowledgement messages).</i>
--------------------	--

T2S Framework Agreement

Schedule 7 – Pricing

Some worked examples for the Pricing of information services:

Item	Transmission fee (in eurocent)	Business item fee (in eurocent)	Fixed fee	Total charge
A2A report sent to a T2S Actor containing 100 business items	1.2 eurocent (for sending the report)	40 eurocent (100 x 0.4 eurocent for each business item contained in the report)	-	41.2 eurocent
A file containing 100 messages, sent by a T2S Actor to the T2S Platform	1.2 eurocent (for receiving the file)	40 eurocent (100 x 0.4 eurocent for each message bundled into the file)	-	41.2 eurocent
A2A query request and the subsequent response containing 100 business items	2.4 eurocent (1.2 eurocent for the A2A query request message and 1.2 eurocent for the A2A query response)	70 eurocent (100 x 0.7 eurocent for each queried business item)	-	72.4 eurocent
100 (individual) messages sent by T2S to a T2S Actor	120 eurocent (100 x 1.2 eurocent for each message)	-	-	120 eurocent
U2A query on the GUI	-	-	10 eurocent	10 eurocent
U2A query containing 100 business items, viewed on the GUI and then subsequently downloaded	-	70 eurocent (100 x 0.7 eurocent for each queried business item)	10 eurocent (for the initial viewing on the GUI)	80 eurocent

T2S Framework Agreement

Schedule 7 – Pricing

4.4 Tariff items initially priced at zero

T2S is sized in accordance with expected consumption patterns, i.e. the anticipated distribution of settlement volumes during night-/day-time and peak hours. The items in this section are set at a zero price, presuming that actual usage of T2S remains within the expected consumption patterns over time. However, should there be a stronger than expected use of T2S resources and the volume distribution pattern be different from expected thus adversely affecting T2S performance, these items may be charged. The Eurosystem regularly reviews the actual usage of T2S resources against expected consumption patterns.

Daytime congestion charge

Price	Zero eurocent per instruction
DvP weight factor	0%
Background	<i>An additional congestion surcharge may be applied to settlement instructions successfully executed during the last two hours prior to the DvP cut-off time (i.e. indicatively between 14:00 – 16:00). Initially this “congestion charge” is set at 0 eurocent but if it is found that too many instructions are executed during the period and hence causing congestion, a fee may be applied.</i>
Fee trigger	<i>Any DvP, FoP or PFOD instruction successfully settled during the last two hours prior to the DvP cut-off time (i.e. indicatively between 14:00 – 16:00) would attract the daytime congestion surcharge.</i>

Auto collateralisation service with a Central Bank

Price	Zero eurocent per transaction
DvP weight factor	0%
Background	<i>All transactions resulting from auto-collateralisation with a Central Bank would be charged an all-in-one fee. Only the collateral provider would be charged.</i>
Fee trigger	<i>All successfully processed auto-collateralisation transactions with a Central Bank within the monthly billing period.</i>

Daytime settlement of ‘high’ priority and ‘top’ priority instructions

T2S Framework Agreement

Schedule 7 – Pricing

Price	Zero eurocent per instruction
DvP weight factor	0%
Background	<p>All 'Top Priority' and 'High Priority' instructions settled during the period 07:00 – 18:00 would be subject to a surcharge.</p> <p>TOP priority = default assigned to instructions fulfilling predetermined criteria, such as those of trading platforms (multilateral trading facilities, Stock Exchanges, etc.) with and without a central clearing counterparty (CCP) as well as over the counter (OTC) instructions with a CCP (URD 7.2.2.2). Special instructions assigned by Central Banks or Signatory CSDs with a 'reserved priority' (e.g. Central Bank monetary policy operations) would attract the same charge.</p> <p>HIGH priority = can be assigned by T2S Users to OTC transactions (without CCP) in the relevant settlement instruction. High priority instructions follow in the processing hierarchy after top priority instructions (URD 7.2.2.3).</p>
Fee trigger	<p>Instructions flagged with 'Top Priority' or 'High Priority' which are settled in the period 07:00 – 18:00. If a Signatory CSD's priority traffic exceeds 20% of its total settlement volume within the monthly billing period, the Eurosystem discusses the matter with the respective Signatory CSD to assess the reason for such high usage. Should usage not be brought into a range below 20%, the Signatory CSD will be billed for the priority fee and charges may apply after a notification period of 60 days.</p>

Cancellation

Price	Zero eurocent per instruction
DvP weight factor	0%
Background	<p>The cancellation of a settlement instruction which had been submitted previously needs to be validated and the original settlement instruction is flagged as successfully cancelled. In cases where the instruction has already been matched, each side of the cancellation would be charged. Cancellation instructions which are not successfully executed or have been denied are not charged.</p>

T2S Framework Agreement

Schedule 7 – Pricing

Fee trigger	<i>All instructions that have been successfully cancelled. Successful automatic cancellation of settlement instructions by the Instruction Maintenance Module would also be charged. All previously attracted chargeable status (e.g. Matched, partial settlement, Intended Settlement Date fail) would be charged as well.</i>
--------------------	---

Settlement modification

Price	Zero eurocent per instruction
DvP weight factor	<i>0%</i>
Background	<i>Settlement instruction modifications include any change of the Hold status (CSD hold status/ CSD validation hold status/ party hold status/ CSD hold status), all release instructions, change of priority, change of partial settlement indicator and linkage block. All relevant default settings do not attract a charge because they are driven by the relevant reference data.</i>
Fee trigger	<i>Any successfully executed settlement modification instruction leading to a change in status.</i>

Fee per T2S Dedicated Cash Account

Price	Zero euro monthly per T2S Dedicated Cash Account
Background	<i>Monthly fixed fee to cover for the maintenance of the reference data. This fee would be charged to respective T2S Users via their Central Bank.</i>
Fee trigger	<i>Any T2S Dedicated Cash Account with the account status 'open' at the end of the monthly billing period or if it was closed during the billing period.</i>

4.5 Tariff items priced at zero at least until end of cost-recovery period

Securities Account fees

Securities Account fees are set at zero at least until the end of the Cost Recovery Period.

Price	<p>Option a) Zero eurocent monthly per ISIN in a Securities Account Option b) Zero euros monthly per Securities Account</p>
Background	<p><i>Increased numbers of ISINs in an account in general means more resource associated with maintaining reference data for the account.</i></p> <p><i>There is the choice between:</i></p> <p><i>Option a) each Securities Account open in the database of T2S and active during the billing period attracts a monthly fixed fee which is be applied for each ISIN held in the account; or</i></p> <p><i>Option b) each Securities Account open in the database of T2S attracts a monthly fixed fee to cover for the maintenance of a Securities Account reference data.</i></p> <p><i>Should Signatory CSDs offer the option, T2S Users can choose which option to be applied. The decision should be stable in the long term.</i></p>
Fee trigger	<p><u>Option a)</u> <i>All ISIN positions at the end of the monthly billing period within a Securities Account which was active during the billing period and the account flagged to be charged by ISIN attracts a fixed fee per ISIN position in the account</i></p> <p><u>Option b)</u> <i>Any Securities Account <u>not</u> flagged to be charged by ISIN with the account status ‘open’ at the end of the monthly billing period attracts a fixed fee. This fixed fee is also applied to accounts closed during the billing period.</i></p>

5 Inventory of T2S service charges

5.1 Introduction

The Inventory of T2S service charges (the Inventory) provides T2S Users with a description of how T2S will finance changes (which, depending on the type of change, could potentially result in increases of T2S prices included in the T2S price list), and a number of other services not covered in the T2S price list. The present content of the Inventory is not necessarily exhaustive but could potentially be expanded to encompass other types of service charges. If the list were to be expanded at a later stage, the general principle of charging at cost shall remain.

5.2 Changes

The process for how changes will be implemented to the T2S Services is described in Schedule 9 on 'Change and Release Management'. The following section describes how the costs for Common Changes and Specific Changes of the T2S Services are to be recovered.

5.2.1 T2S Common Changes

Common Changes are defined as “any new feature, functionality or service – or any amendment of an existing feature, functionality or service – which is implemented for the benefit of all T2S Actors”. Prior to going ahead and implementing a Change Request, the Eurosystem will specify the development and running costs of the change. This will be a binding offer on behalf of the Eurosystem.

Those Common Changes that are classified as “corrective maintenance” (i.e. fixing of errors in coding, design or detailed specifications (bug fixes)” and “technical maintenance” (i.e. software adaptations and/or testing activities imposed by changes of the hardware or the operating system or other infrastructural software packages within certain resource limits) will not be charged separately.

All other Common Changes will first need to be financed by the Eurosystem and the Governing Council needs to decide to increase the financial envelope of T2S by the cost of such a change. Substantial increases in the financial envelope could result in the need to adjust the T2S price list at some stage and/or to lengthen the amortisation period and/or to establish separate amortisation cycles. The development costs, running costs and capital costs associated with these Common Changes will therefore have to be recovered through T2S fees (see T2S price list) over an amortisation period.

T2S Framework Agreement

Schedule 7 – Pricing

The Signatory CSDs commit to bear any residual costs related to Common Changes requested by them that cannot be recovered through T2S fees.

5.2.2 T2S Specific Changes

Based on the principle of non-exclusiveness and non-discrimination, the functionality would in principle be available to all initial and future T2S parties. However, those not wishing to use the new functionality would not be impacted and therefore would not bear any of the costs.

Prior to a Specific Change Request being approved, the Eurosystem will specify the full financial consequences associated with the change (e.g. the implementation costs, the running costs, capital costs and potentially lost revenues). The estimate of the implementation costs will be a binding offer on behalf of the Eurosystem.

Once the Specific Change Request has been approved and before the Eurosystem starts development activities, the entities requesting the change (“requesters”) will formally commit to bear the full financial consequences of the change and agree with the T2S Board on the financing of the Specific Change. The financing of Specific Changes may be in the form of either pre-financing, financing via transaction fees levied on the use of the specific functionality or any other recovery method to be agreed between the requesters and the T2S Board.

Entities which have not been part of the original agreement between the Eurosystem and the requesters to develop a specific functionality but decide to use such functionality at a later stage (“late-joiners”) will have to bear an appropriate share of the financial consequences. The requesters that initially requested the specific functionality shall seek an agreement with the late-joiner(s) for the revised allocation of financial consequences of such functionality. If original requesters and the late-joiner(s) cannot find an agreement on the revised allocation of the full financial consequences of that functionality, a panel of experts (nominated by the Signatory CSDs in line with Arbitration rules) will decide on a revised allocation, using objective criteria in order to ensure non-discrimination, to avoid duplication of Specific Changes and to keep T2S open for new developments. Subject to the late-joiner having paid or committed to pay its share of the full financial consequences of the Specific Change in accordance with the revised allocation, it will be able to use the specific functionality.

5.2.3 Pricing of assessments of Change Requests

Preliminary assessments of a request for a functional change will attract a charge of €2,000. If, based on the results of the preliminary assessment, the Party then decides to

request a detailed assessment for the functional change, the detailed assessment will attract an additional charge of €10,000.

If the Change Request is subsequently approved and implemented, either as a Common Change or Specific Change, the costs of the preliminary and detailed assessments will be added to the total cost of the change (and recovered in the manner described in sections 5.2.1 and 5.2.2).

If the change is rejected, the costs of the preliminary and detailed assessment would be charged directly to the requester. In case there is more than one requester, the costs of the preliminary assessments and detailed assessments would be distributed equally.

5.3 RTGS fees for connecting to T2S

If an RTGS system charges T2S a fee for connecting to T2S, T2S will not charge this fee to its Signatory CSDs. T2S will annually charge such fee back to the Central Bank that operates the T2S Dedicated Cash Account in the currency in which the RTGS system operates. As a matter of service, T2S will annually provide each Central Bank operating a T2S Dedicated Cash Account with each Payment Bank's annual share in the total number of postings on that T2S Dedicated Cash Account and the Central Bank might take that into account when allocating the charges.

5.4 Training

The Eurosystem will provide training by qualified trainers to interested parties on the structural and operational aspects of T2S. Such general training which T2S offers to all T2S Stakeholders will be free of charge. Tailor-made training will be charged to the requesting party on a per diem basis. The Eurosystem will charge training services at cost. T2S training course offerings and associated charges will be published on a regular basis.

5.5 Consultancy

The Eurosystem may provide resources on request of a Signatory CSD, Central Bank or a Directly Connected Party to provide advice and support improving their technical infrastructure interaction with the T2S Platform. Specific consultancy will be charged to the requesting party on a per diem basis. The Eurosystem will charge the consultancy services that it provides at cost.

5.6 Request for an additional test environment

The Eurosystem will be providing two test environments for User Testing during Migration and post-migration without charging any additional service charge.

The Eurosystem will provide additional test environments subject to an approved Change Request. If Signatory CSDs/Central Bank would require additional test environments, the set-up costs of the test environment as well as daily maintenance fees will be charged at cost either as a Common or a Specific Change.

If the additional test environment(s) is charged as a Specific Change, the fee will be included in the respective Signatory CSD/Central Bank bill as soon as the relevant test environment is ready for testing.

5.7 Securities Reference Data

If the Eurosystem were to provide the securities maintaining services to Signatory CSDs, it will charge these services at cost.

5.8 Conditional Participation Fee and One-off joining fee

Any Signatory CSD joining T2S will pay the Conditional Participation Fee, according to the conditions set out in Article 19 of this Agreement, as well as a one-off joining fee in the amount of 25% of the annual fee that this Signatory CSD will pay to T2S, calculated on the basis of the fee paid in the first full year of T2S operation of the Signatory CSD in question. The one-off joining fee will be calculated and charged one year after the Signatory CSD will have started its operations in T2S.

5.9 Exit Management

If a Signatory CSD terminates the T2S Framework Agreement for convenience, the Eurosystem will invoice the Signatory CSD at cost for all planning, co-ordination and execution of exit activities that go beyond normal operational support. This will also be the case if a Signatory CSD decides to exit because the relevant non-euro area NCB in T2S no longer outsources its currency.

If a Signatory CSD has terminated the T2S Framework Agreement for cause, the Eurosystem will provide the support for exit activities free of charge.

5.10 External Examiner

In case of a regular or special examination, as provided in Article 26.4 and 26.6 of T2S Framework Agreement, 50% of the total cost charged by the External Examiner shall be borne by the Eurosystem and 50% by the Signatory CSD(s).

5.11 Reimbursements of costs for storing data

If a Signatory CSD requests the Eurosystem to maintain documentation and records for a period longer than specified in Article 26.9 of the T2S Framework Agreement, the Eurosystem is entitled to reimbursement of any reasonable costs incurred as a result of such further maintenance.



EUROPEAN CENTRAL BANK

EUROSYSTEM

T2S FRAMEWORK AGREEMENT

ANNEX 1 TO SCHEDULE 7

LIST OF REPORTS AND QUERIES AND ASSOCIATED BUSINESS ITEMS

T2S Framework Agreement

Schedule 7 – Annex 1 – List of reports and queries and associated business items

Table of contents

1	List of A2A reports and business items	3
2	List of A2A queries and business items	5
3	List of U2A reports and business items	8

T2S Framework Agreement

Schedule 7 – Annex 1 – List of reports and queries and associated business items

1 List of A2A reports and business items

Report Name	Business Item
Current Settlement Day Cash Information Report	T2S Dedicated Cash Account
Following Settlement Day Cash Forecast Report	T2S Dedicated Cash Account
Statement of Accounts	Cash Posting
Statement of Settlement Allegements	Allegement
Statement of executed amendment instructions for Intra-Balance Movements	Amendment Instruction
Statement of executed amendment instructions for Intra-Position Movements and Settlement Instructions	Amendment Instruction
Statement of executed cancellation instructions for Intra-Balance Movements	Cancellation Instruction
Statement of executed cancellation instructions for Intra-Position Movements and Settlement Instructions	Cancellation Instruction
Statement of Holdings	Securities Position
ECMS Statement of Holdings	Securities Position
Statement of pending amendment instructions for Intra-Balance Movements	Amendment Instruction
Statement of pending amendment instructions for Intra-Position Movements and Settlement Instructions	Amendment Instruction
Statement of pending cancellation instructions for Intra-Balance Movements	Cancellation Instruction
Statement of pending cancellation instructions for Intra-Position Movements and Settlement Instructions	Cancellation Instruction
Statement of Pending Instructions	Settlement Instruction
ECMS Statement of Pending Instructions	Settlement Instruction
Statement of pending intra-balance movements	Intra-Balance Movement

T2S Framework Agreement

Schedule 7 – Annex 1 – List of reports and queries and associated business items

Report Name	Business Item
Statement of pending intra-position movements	Intra-Position Movement
Statement of settled intra-balance movements	Intra-Balance Movement
Statement of settled intra-position movements	Intra-Position Movement
Statement of Reference Data for Party	Party
Statement of Reference Data for Securities	Security
Statement of Reference Data for Securities Accounts	Securities Account
Statement of Reference Data for T2S Dedicated Cash Accounts	T2S Dedicated Cash Account
Statement of Transactions	Settlement Instruction
ECMS Statement of Transactions	Settlement Instruction

T2S Framework Agreement

Schedule 7 – Annex 1 – List of reports and queries and associated business items

2 List of A2A queries and business items

Query name	Business Item
Amendment Instruction Query for Intra Balance Movements	Amendment Instruction
Amendment Instruction Query for Intra Position Movements and Settlement Instructions	Amendment Instruction
Cancellation Instructions for Intra Balance Movements Query	Cancellation Instruction
Cancellation Instructions for SI + Intra Position Movements Query	Cancellation Instruction
Cash Forecast Query	T2S Dedicated Cash Account
Collateral Value of a Security Query	T2S Dedicated Cash Account
Collateral Value per T2S Dedicated Cash Account Query	T2S Dedicated Cash Account
Cumulative Billing Data Query	Party
Current Status of the T2S settlement day	Business Day
Immediate Liquidity Transfer Order Detail Query	Immediate Liquidity Transfer Order
Immediate Liquidity Transfer Order List Query	Immediate Liquidity Transfer Order
Intra Balance Movements Query	Intra Balance Movement
Intra Position Movements Query	Intra Position Movement
ISIN List Query	Security
Itemised Billing Data Query	Billing Item
Limit Query	Limit
Limit Utilisation Journal Query	Limit
Limit Utilisation Query	Limit

T2S Framework Agreement

Schedule 7 – Annex 1 – List of reports and queries and associated business items

Query name	Business Item
Liquidity Information Query	T2S dedicated cash account
Liquidity Transfer Order Detail Query	Standing or Predefined Liquidity Transfer Order
Liquidity Transfer Order Link Set Query	Liquidity Transfer Order Link Set
Liquidity Transfer Order List Query	Standing or Predefined Liquidity Transfer Order
Liquidity Transfer Order of a Liquidity Transfer Order Link Set Query	Standing or Predefined Liquidity Transfer Order
Outstanding Auto-Collateralisation Credit Query	T2S Dedicated Cash Account
Party List Query	Party
Party Reference Data Query	Party
Report Details Query	Report
Restricted Party Query	Party
Securities Account List Query	Securities Account
Securities Account Position (History) Query	Securities Position
Securities Account Reference Data Query	Securities Account
Securities CSD Link Query	Security
Securities Deviating Nominal Query	Security
Securities Reference Data Query	Security
Settlement Instruction Audit Trail Query	Settlement Instruction
Settlement Instruction Current Status Query	Settlement Instruction
Settlement Instruction Query	Settlement Instruction
Settlement Instruction Status Audit Trail Query	Settlement Instruction
Reference Data Audit Trail Security Query	Security
Reference Data Audit Trail Party Query	Party
Reference Data Audit Trail Securities Account Query	Securities Account

T2S Framework Agreement

Schedule 7 – Annex 1 – List of reports and queries and associated business items

Query name	Business Item
Reference Data Audit Trail T2S DCA Query	T2S Dedicated Cash Account
T2S Calendar Query	Dates
T2S Dedicated Cash Account Balance Query	T2S Dedicated Cash Account
T2S Dedicated Cash Account List Query	T2S Dedicated Cash Account
T2S Dedicated Cash Account Posting Query	Cash Posting
T2S Dedicated Cash Account Reference Data Query	T2S Dedicated Cash Account
T2S Diary Query	Business Day
T2S Overall Liquidity Query	Party
Total amount of standing and predefined orders Query	Party
Total collateral value per T2S Dedicated Cash Account Query	T2S Dedicated Cash Account

T2S Framework Agreement

Schedule 7 – Annex 1 – List of reports and queries and associated business items

3 List of U2A reports and business items

Note: When the business item of a U2A query is referred to as “fixed”, it means that only one business item per query will be counted and charged for.

Query name	Business Item
Allegation Instruction Query	Allegation
Amendment Instruction List Query	Amendment Instruction
Amendment Instruction Query for Intra Balance Movements	Amendment Instruction
Amendment Instruction Query for Intra Position Movements and Settlement Instructions	Amendment Instruction
Attribute Domain Details Query	fixed
Attribute Domain List Query	fixed
Attribute Reference Details Query	fixed
Attribute Reference List Query	fixed
Auto-Collateralisation Eligibility Links Query	fixed
Broadcast Query	fixed
Cancellation Instructions for Intra Balance Movements Query	Cancellation Instruction
Cancellation Instructions for SI + Intra Position Movements Query	Cancellation Instruction
Cash Discount Penalty Rate Query	Cash Discount Penalty Rate
Cash Forecast Query	T2S Dedicated Cash Account
Close Links Query	fixed
Closing Day Query	fixed
CMB Details Query	fixed
CMB List Query	fixed
CMB Securities Account Link Details Query	fixed

T2S Framework Agreement

Schedule 7 – Annex 1 – List of reports and queries and associated business items

Query name	Business Item
CMB Securities Account Links List Query	fixed
Collateral Value of a Security Query	T2S Dedicated Cash Account
Collateral Value per T2S Dedicated Cash Account Query	T2S Dedicated Cash Account
Conditional Security Delivery Rule Details Query	fixed
Conditional Security Delivery Rule Query	fixed
Conditional Security Delivery Rule Set Details Query	fixed
Conditional Security Delivery Rule Set Query	fixed
Country Query	fixed
CSD Account Links Query	fixed
Cumulative Billing Data List Query	Party
Cumulative Billing Data Query	Party
Currency Query	fixed
Current Status of the T2S settlement day	Business Day
Daily Price Query	Daily Price
Data Changes Details Query	fixed
Data Changes Query	fixed
Default Event Schedule Details Query	fixed
Dynamic Data Audit Trail Details Query	fixed
Dynamic Data Audit Trail List Query	fixed
Eligible Counterpart CSD List Query	fixed
Eligible Counterpart CSD Query	fixed
Euro Foreign Exchange Rate Query	Euro Foreign Exchange Reference Rate
Event Type Details Query	fixed
Event Type List Query	fixed
External RTGS Account Details Query	fixed

T2S Framework Agreement

Schedule 7 – Annex 1 – List of reports and queries and associated business items

Query name	Business Item
External RTGS Account List Query	fixed
Grant/Revoke Privileges List Query	fixed
Grant/Revoke Roles List Query	fixed
Hold/Release Instruction Query	fixed
Immediate Liquidity Transfer Order Detail Query	Immediate Liquidity Transfer Order
Immediate Liquidity Transfer Order List Query	Immediate Liquidity Transfer Order
Inbound Files Details Query	fixed
Inbound Files List Query	fixed
Inbound Message Details Query	fixed
Inbound Message List Query	fixed
Intra Balance Movements Query	Intra Balance Movement
Intra Position Movements Query	Intra Position Movement
ISIN List Query	Security
Itemised Billing Data List Query	Billing Item
Itemised Billing Data Query	Billing Item
Limit List Query	Limit
Limit Query	Limit
Limit Utilisation Journal Query	Limit
Limit Utilisation Query	Limit
Liquidity Transfer Order Detail Query	Standing or Predefined Liquidity Transfer Order
Liquidity Transfer Order Link Set Query	Liquidity Transfer Order Link Set
Liquidity Transfer Order List Query	Standing or Predefined Liquidity Transfer Order
Liquidity Transfer Order of a Liquidity Transfer Order Link Set Query	Standing or Predefined Liquidity Transfer Order

T2S Framework Agreement

Schedule 7 – Annex 1 – List of reports and queries and associated business items

Query name	Business Item
Market-specific Attribute Details Query	fixed
Market-specific Attribute Query	fixed
Market-specific Restriction List Query	fixed
Market-specific Restriction Type Rule Detail Query	fixed
Market-specific Restriction Type Rule Set List Query	fixed
Market-specific Restriction Type Details Query	fixed
Market-specific Restriction Type Rule Sets -Display Rule Sets Matrix Query	fixed
Message Subscription Rule Details Query	fixed
Message Subscription Rule Query	fixed
Message Subscription Rule Set Details Query	fixed
Message Subscription Rule Set Query	fixed
Network Service List query	fixed
Operating Day Types Details Query	fixed
Operating Day Types List Query	fixed
Outbound Files Details Query	File
Outbound Files List Query	File
Outbound Message Details Query	Message
Outbound Message List Query	Message
Outstanding Auto-Collateralisation Credit Query	T2S Dedicated Cash Account
Partial Settlement Threshold Group Query	fixed
Party List Query	Party
Party Reference Data Query	Party
Privilege Query	fixed
Report Configuration Detail Query	fixed
Report Configuration List Query	fixed

T2S Framework Agreement

Schedule 7 – Annex 1 – List of reports and queries and associated business items

Query name	Business Item
Report Details Query	Report
Report Query	Report
Restricted Party Query	Party
Role Details Query	fixed
Role Query	fixed
Routing Details Query	fixed
Routing Query	fixed
Secured Group Details Query	fixed
Secured Group List Query	fixed
Secured Object	fixed
Securities Account List Query	Securities Account
Securities Account Position Query	Securities Position
Securities Account Reference Data Query	Securities Account
Securities CSD Link Query	Security
Securities Deviating Nominal Query	Security
Securities Position Detailed Restriction Details Query	Security
Securities Posting Query	Securities Posting
Securities Reference Data Query	Security
Securities Subject to Cash Penalties Query	Securities Subject to Cash Penalties
Securities Valuations Query	Security
Security Penalty Rate Query	Security Penalty Rate
Service Item Details Query	fixed
Service Item Query	fixed
Settlement Instruction Audit Trail Query	Settlement Instruction
Settlement Instruction Current Status Query	Settlement Instruction
Settlement Instruction Query	Settlement Instruction

T2S Framework Agreement

Schedule 7 – Annex 1 – List of reports and queries and associated business items

Query name	Business Item
Settlement Instruction Status Audit Trail Query	Settlement Instruction
SME Growth Market Query	SME Growth Market
Reference Data Audit Trail Security Query	Security
Reference Data Audit Trail Party Query	Party
Reference Data Audit Trail Securities Account Query	Securities Account
Reference Data Audit Trail T2S DCA Query	T2S Dedicated Cash Account
SWIFT BIC Query	fixed
System Entity Query	fixed
T2S Calendar Query	Dates
T2S Dedicated Cash Account Balance Detailed Restrictions Query	T2S Dedicated Cash Account
T2S Dedicated Cash Account Balance Query	T2S Dedicated Cash Account
T2S Dedicated Cash Account List Query	T2S Dedicated Cash Account
T2S Dedicated Cash Account Posting Query	Cash Posting
T2S Dedicated Cash Account Reference Data Query	T2S Dedicated Cash Account
T2S Diary Query	Business Day
T2S Overall Liquidity Query	Party
T2S System User Query (T2S Actor Query)	fixed
Technical Addresses Network Services Link Details Query	fixed
Technical Addresses Network Services Links List Query	fixed
Tolerance Amount Query	fixed
Total amount of standing and predefined orders Query	Party

T2S Framework Agreement

Schedule 7 – Annex 1 – List of reports and queries and associated business items

Query name	Business Item
Total collateral value per T2S Dedicated Cash Account Query	T2S Dedicated Cash Account



EUROPEAN CENTRAL BANK
EUROSYSTEM

T2S FRAMEWORK AGREEMENT

SCHEDULE 8 GOVERNANCE

T2S Framework Agreement

Schedule 8 – Governance

Table of contents

Preamble.....	3
1 Governance bodies	5
2 Technical Groups supporting the Governance bodies	7
3 Decision-making on relevant matters other than Change Requests	9
4 Transparency	11

Annexed to this Schedule are:

Annex 1 – Mandate of the T2S CSG

Annex 2 – T2S deliverables: list and management process

Annex 3 – Joint Controllership Arrangement

T2S Framework Agreement

Schedule 8 – Governance

Preamble

This Schedule sets out the Governance of T2S. The Governance applies as of the Agreement Date.

The Parties agree that:

- 1 The aim of the Governance principles is to provide each T2S Stakeholder with the level of control necessary in further pursuing its commercial and policy objectives and to seek compliance with Legal and Regulatory Requirements. However, the Parties agree that, since T2S is a multilateral environment, their level of control is necessarily lower than if each T2S signatory had its own environment.
- 2 Control is necessary to ensure that T2S operates safely and efficiently. Moreover, control shall allow change to be achieved and managed to ensure that changes that are proposed by one Party/Parties can be introduced without unduly affecting the other Party/Parties.
- 3 In order to achieve the necessary balance of control, it is very important that transparency is ensured and that all T2S Stakeholders are closely involved in the Governance of T2S. It is essential to ensure that T2S meets the evolving needs of the market in a consensual way. Transparency shall assure the T2S Stakeholders that final decisions will not be taken before their positions are considered by the relevant Governance body and by the other T2S Stakeholders. For this reason, technical and policy documents, such as the User Requirements Document, the Economic Impact Analysis and the T2S Governance arrangement were extensively discussed with market participants and published on the ECB website. The Eurosystem intends to continue doing so.
- 4 The procedure for the decision-making on Change Requests necessary for the proper and appropriate Governance of T2S is described in Schedule 9 (Change and Release Management). It ensures, on the one hand, that the Signatory CSDs keep the main responsibility for the evolution of the rules concerning the core of their settlement activity as they outsource to T2S a core part of their IT functions (the processing of Transfer Orders and the technical maintenance of their Securities Account database). In doing so, they need to comply with Legal and Regulatory Requirements and be able to exercise a sufficient degree of control over the functioning rules of Securities Accounts. The procedure also ensures, on the other hand, that the Governing Council will not have to implement measures that are not compliant with the mandate of Central Banks in general, with the statute

T2S Framework Agreement

Schedule 8 – Governance

of the European System of Central Banks and of the ECB in particular, or that would conflict with the interest of the smooth functioning of T2S.

- 5 The use of a single multilateral infrastructure by the Signatory CSDs inevitably affects the way in which they exercise their management and control functions in respect of the operations outsourced to T2S. At the same time, the Eurosystem provides harmonised T2S Services, thereby fulfilling its statutory tasks. This constitutes an outsourcing relationship different from a conventional one since it requires that the outsourcing service be constructed not exclusively by reference to the specific needs of the outsourcer (i.e. the CSDs) but also according to the public tasks entrusted to the outsourcee (i.e. Eurosystem).
- 6 The customers of the Signatory CSDs, and ultimately issuers and investors are beneficiaries of T2S. Their requirements have to be appropriately taken into account when further developing T2S functionalities in order to ensure that T2S continues to meet the needs of the market.

On the basis of the above considerations, Section 1 explains the relationship of the different Governance bodies in the decision-making process. Additional Governance arrangements are outlined in Section 3.

T2S Framework Agreement

Schedule 8 – Governance

1 Governance bodies

In accordance with Article 27 of the T2S Framework Agreement, the T2S Governance bodies involved in the decision-making process are the following:

- the Market Infrastructure Board (MIB), whose mandate and composition are set out in Decision (EU) 2019/166 of the European Central Bank of 25 January 2019;
- the T2S CSD Steering Group (T2S CSG), whose mandate and composition are Annexed to this Schedule;
- the T2S Non-euro Currencies Steering Group (T2S NECSG), whose mandate and composition are set out in Schedule 8 (Governance) of the T2S Currency Participation Agreement;
- the Governors' Forum, whose mandate and composition are part of the Schedule 8 (Governance) of the T2S Currency Participation Agreement;
- the Advisory Group on Market Infrastructures for Securities and Collateral (AMI-SeCo), whose mandate and composition are set out in the Annex to Guideline ECB/2010/2 of 21 April 2010 on TARGET2-Securities; and
- the National Stakeholder Group (NSGs), whose mandate and composition are set out in the Annex to the Guideline ECB/2012/13 of 18 July 2012, as amended, on TARGET2-Securities. The NSGs link the respective national market with the AMI-SeCo.

T2S Framework Agreement

Schedule 8 – Governance

Figure 1: T2S Governance bodies***

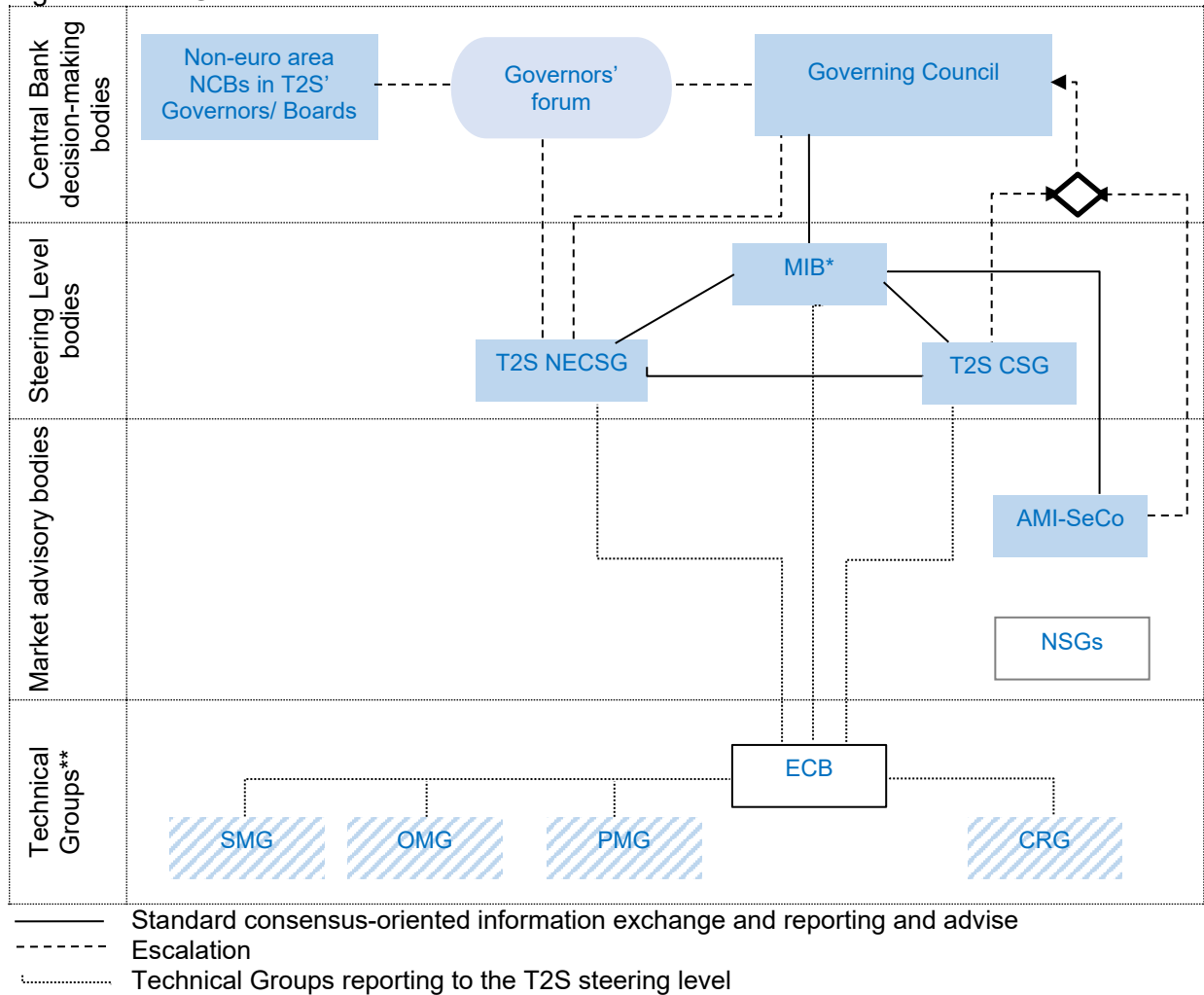

SMG: Security Managers Group, OMG: Operations Managers Group, PMG: Project Managers Group, CRG: Change Review Group

This chart constitutes a visual representation of the T2S Governance bodies which are involved in the decision-making process of T2S. The chart has no legal value. In case of inconsistencies between this chart and any provisions of the T2S Framework Agreement, the latter shall prevail.

Note: * The MIB is the Eurosystem Governance body at the T2S Steering Level for matters which have been delegated by the Governing Council. The MIB liaises with other Eurosystem internal Governance structures for issues of common concern.

** The ECB routes the reporting and the information to the respective addressees.*** Not including sub-groups.

T2S Framework Agreement

Schedule 8 – Governance

2 Technical Groups supporting the Governance bodies

To deal with T2S issues that are within its remit, each Governance body has the possibility to establish or dissolve Technical Groups. The MIB shall make proposals to avoid duplication of substructures on similar topics.

The Technical Groups shall in particular:

- (a) ensure that T2S and subsequent releases go-live and that the Signatory CSDs, as well as Central Banks, are duly and timely prepared, including with regard to the relevant aspects of User Testing and Migration;
- (b) review the CSD-relevant planning and reporting, including risks and issues;
- (c) assess Change Requests, as defined in Schedule 9 (Change and Release Management);
- (d) coordinate and monitor the operational risk management, T2S Information Security Risk Management and Cyber Resilience activities;
- (e) develop and maintain the Manual of Operational Procedures; and
- (f) meet the Eurosystem to review the T2S service performance against the SLA.

The Technical Groups shall report to the relevant Governance bodies. The Technical Groups have the possibility to exchange relevant information directly among themselves. They organise their work in an efficient manner to fulfil their mandates, including the possible creation of their own substructures.

The Technical Groups established by the T2S Steering Level and currently active are:

- (a) PMG: Project Managers Group:
 - Composition: consisting of project managers of the Signatory CSDs, euro area NCBs, non-euro area NCBs in T2S, the ECB and 4CB.
 - Chairperson: The MIB shall appoint the chairperson of the PMG on the basis of her/his technical expertise after consultation with the T2S CSG and the T2S NECSG.
 - Reporting line: The PMG reports to Governance bodies belonging to the T2S Steering level via the ECB.
 - Scope (inter alia): The PMG needs to ensure that T2S releases go live and that migrating CSDs as well as Central Banks are duly and timely prepared and migrated.

T2S Framework Agreement

Schedule 8 – Governance

- (b) CRG: Change Review Group
- Composition: consisting of product managers and functional experts of the Signatory CSDs, euro area NCBs, non-euro area NCBs in T2S, the ECB and the 4CB. User representatives participate in the CRG as observers.
 - Chairperson: The MIB shall appoint the chairperson of the CRG on the basis of her/his technical expertise after consultation with the T2S CSG and the T2S NECSG.
 - Reporting line: The CRG reports to Governance bodies belonging to the T2S Steering level via the ECB. The ECB disseminates the deliverables of the CRG also to the AMI-SeCo.
 - Scope (inter alia): The CRG assesses Change Requests as defined in Schedule 9 (Change and Release Management). The CRG and the PMG also need to exchange information regarding the impact of changes on the T2S release timeline.
- (c) OMG: Operations Managers Group
- Composition: consisting of operations experts of the Signatory CSDs, euro area NCBs, non-euro area NCBs in T2S, the ECB and 4CB. Representatives of Users which are Directly Connected Parties participate in the OMG as observers for specific agenda items.
 - Chairperson: The MIB shall appoint the chairperson of the OMG on the basis of her/his technical expertise after consultation with the T2S CSG and the T2S NECSG.
 - Reporting line: The OMG reports to the Governance bodies belonging to the T2S Steering level via the ECB.
 - Scope (inter alia): It develops and maintains the Manual of Operational Procedures, meets to review the T2S Service performance against the SLA and coordinates the management of operational Incidents.
- (d) SMG: Security Managers Group
- Composition: consisting of Cyber Resilience and Information Security experts of the Signatory CSDs, euro area NCBs, non-euro area NCBs in T2S, the ECB and the 4CB.

T2S Framework Agreement

Schedule 8 – Governance

- Chairperson: The MIB shall appoint the chairperson of the SMG on the basis of her/his technical expertise after consultation with the T2S CSG and the T2S NECSG.
- Reporting line: The SMG reports to the Governance bodies belonging to the T2S Steering level via the ECB.
- Scope (inter alia): The SMG coordinates and monitors all the T2S Information Security Risk Management and Cyber Resilience activities.

3 Decision-making on relevant matters other than Change Requests

1. Each of the Signatory CSDs, euro area NCBs, non-euro area NCBs in T2S, the ECB, the 4CB or User members in the AMI-SeCo may, outside the scope of Change Requests, propose a resolution or, in particular in the case of the AMI-SeCo, an advice concerning relevant matters of T2S ¹ to the MIB or, in exceptional circumstances, to the Governing Council.
2. In all Governance bodies the chairperson may decide that the proposal for a resolution or an advice needs first to be analysed by a substructure, i.e. a Technical Group (permanent) or by a task force (ad-hoc). The MIB or, in exceptional circumstances, the Governing Council organises the procedure in such a way that all Governance bodies are properly consulted within a reasonable amount of time and without duplicating substructures on similar topics. In case of divergence of views between different Governance bodies, the MIB shall aim at reconciling the different views. The T2S CSG or the T2S NECSG can, upon agreement with the MIB, ask for a non-binding external advice for relevant matters of T2S except for matters related to safeguarding the integrity of currencies in T2S or to financial stability. The Third-Party providing such advice needs to be selected by common agreement of the MIB, the T2S CSG and the T2S NECSG and shall deliver its advice in parallel to the MIB, the AMI-SeCo, the T2S CSG and the T2S NECSG.
3. A decision on the proposal is taken by the Governing Council or, for matters which have been delegated by the Governing Council, by the MIB after consultation of the AMI-SeCo, the T2S CSG and the T2S NECSG within a reasonable amount of time, taking into account the urgency of the matter. Differing views between the

¹ Such relevant matters include crisis management, risk issues, operational issues, monitoring the T2S Service (in accordance with the Service Level Agreement), Pricing issues, acceptance for testing and go-live.

T2S Framework Agreement

Schedule 8 – Governance

Eurosystem and non-euro area NCBs in T2S are dealt with according to the relevant procedure defined in the T2S Currency Participation Agreement. The decision of the Governing Council or the MIB shall be published on the ECB website.

4. The Signatory CSDs have the right to challenge the final decision of the Governing Council before the Court of Justice of the European Union.

T2S Framework Agreement

Schedule 8 – Governance

4 Transparency

In order to allow a wide range of market participants to remain closely involved in T2S developments, the extensive T2S transparency regime shall be applied and relevant documentation and information shall be made available on the ECB website. In particular, the Eurosystem's offer of the future updates of the T2S Framework Agreement to all interested CSDs and of the T2S Currency Participation Agreement to all interested non-euro area NCBs shall be made transparent. Furthermore, relevant advice, resolutions and decisions related to Change Requests shall be published on the ECB website. This transparency will allow all T2S Stakeholders to contribute to ongoing T2S discussions and make their views known to relevant Governance bodies.



EUROPEAN CENTRAL BANK
EUROSYSTEM

T2S FRAMEWORK AGREEMENT

SCHEDULE 8 - ANNEX 1 MANDATE OF THE T2S CSG

T2S Framework Agreement

Schedule 8 – Annex 1 - Mandate of the T2S CSG

1. Preamble and Objectives

The Governing Council and the Signatory CSDs agree to establish the CSD Steering Group (T2S CSG) as a governance body according to the T2S Framework Agreement (T2S FA). The T2S CSG discusses all matters of relevance for the Signatory CSDs. The T2S CSG supports the decision-making process in the multilateral T2S Service by providing the Eurosystem with the CSDs' common position on matters of relevance for the Signatory CSDs. The T2S CSG works within the 'Governance' specified in Schedule 8 of the T2S FA.

2. Responsibilities and Tasks

The T2S CSG is responsible for articulating and coordinating the views of the Signatory CSDs within the T2S Governance.

The T2S CSG gives its advice or agrees on a resolution on any topic related to T2S, in particular on:

- any topic brought to the Governing Council that has implications for the T2S FA;
- changes to the T2S FA and its Schedules, in line with the applicable procedures;
- topics of major interest concerning T2S;
- changes to the T2S Scope Defining Set of Documents, in line with the applicable procedures specified in the FA Schedule 8 (Governance) and Schedule 9 (Change and Release Management);
- Change and Release Management, including the prioritisation of Change Requests stemming from Signatory CSDs;
- material subcontracting;
- disputes between the Eurosystem and non-euro area NCBs in T2S;
- any other consultation request of the MIB or the Governing Council;
- crisis management;
- risk, cyber resilience and information security topics;
- operational topics;
- monitoring the T2S Service (in accordance with the Service Level Agreement);
- pricing topics;
- acceptance for testing and go-live; and
- on any matters of relevance in relation to the T2S FA.

On all other matters having an impact on the Signatory CSDs, the T2S CSG is informed about envisaged decisions of the Governing Council or the MIB and the T2S CSG shall be provided with sufficient time to formulate any objections it may have.

T2S Framework Agreement

Schedule 8 – Annex 1 - Mandate of the T2S CSG

A disagreement between one or more Signatory CSDs and the Eurosystem can be escalated from the working and sub-structure level to the T2S CSG and shall follow the dispute resolution and escalation procedure specified in Article 42 of the T2S FA. The dispute resolution and escalation procedure does not preclude a subsequent Arbitration procedure pursuant to Article 43 of the T2S FA.

The T2S CSG's mandate shall be reviewed every three years. The Mandate of the T2S CSG expires with the replacement of the T2S FA by a new agreement and/or with the termination of the T2S FA by the Parties.

3. Composition and Term

The T2S CSG is composed of:

- T2S CSG Members: each of the Signatory CSDs by its CEO or a member of its managing board;
- T2S CSG Observers:
 - up to six User representatives proposed by the MIB and nominated by the Governing Council for a renewable term of two years, based on applications from the European Banking Federation (EBF), the European Savings Bank Group (ESBG), the European Association of Co- operative Banks (EACB), the Association for Financial Markets in Europe (AFME), and the European Association of Clearing Houses (EACH);
 - the MIB Chairperson and members of the MIB.
 - The T2S CSG Chairperson may invite other observers on an ad-hoc basis (e.g. one representative of the 4CB) and may restrict the participation of observers representing Users on an ad hoc basis. The MIB Chairperson is informed of such decisions in advance.

The T2S CSG Chairperson shall be elected from among the T2S CSG Members by the T2S CSG Members for a renewable term of two years. The T2S CSG Chairperson appoints a highly experienced member of staff of the ECB as T2S CSG Secretary. The T2S CSG Chairperson may designate an alternate to replace the T2S CSG Secretary in exceptional circumstances. The T2S CSG Chairperson may invite additional representatives of the Signatory CSDs to attend in order to support the work of the T2S CSG and the T2S CSG Chairperson.

T2S Framework Agreement

Schedule 8 – Annex 1 - Mandate of the T2S CSG

4. Reporting

The T2S CSG gives its advice and makes resolutions to the MIB as the managing body of T2S, upon invitation or on its own initiative. The MIB establishes procedures to inform other T2S Governance bodies of relevant T2S CSG resolutions and advice. The T2S CSG may send its resolutions directly to the Governing Council if the T2S CSG considers that the General Principles of T2S or other core elements of T2S are at risk. The T2S CSG may seek the advice of the AMI-SeCo.

5. Working Procedures

Detailed working procedures are to be specified in the 'Rules of Procedure' drafted by the T2S CSG and endorsed by the Governing Council.

Any T2S CSG Member may propose that a resolution, advice or a resolution on the work organisation of the T2S CSG is taken by the group. T2S CSG resolutions and advice are subject to a double majority, defined as the simple majority of the Signatory CSDs, provided that they represent at least 75% of securities settlement transactions in T2S.

As a rule, the T2S CSG meets once every quarter. Additional meetings may be called by the T2S CSG Chairperson. The dates of the meetings shall be communicated to T2S CSG Members and observers sufficiently in advance. The agenda of each T2S CSG meeting is approved at the beginning of the meeting. Meeting documentation will be circulated sufficiently in advance of meetings, i.e. at the latest five T2S Settlement Days prior to a meeting unless otherwise agreed by the T2S CSG.

In principle, meetings take place at the ECB's premises. However, meetings may also be held by means of teleconferencing. The ECB provides operational and secretarial support to the T2S CSG.

6. Sub-structures

The T2S CSG may establish sub-structures (technical groups, task forces, workstreams and networks) to support its work if considered necessary.

T2S Framework Agreement

Schedule 8 – Annex 1 - Mandate of the T2S CSG

7. Transparency

All relevant documentation and information shall be made available in a secure workspace, accessible to all T2S CSG Members and Observers.

As part of the transparency principle of T2S, the Mandate of the T2S CSG, the T2S CSG Members and Observers list as well as the T2S CSG resolutions, should be published on the ECB website.



EUROPEAN CENTRAL BANK
EUROSYSTEM

T2S FRAMEWORK AGREEMENT

SCHEDULE 8

ANNEX 2 - T2S DELIVERABLES: LIST AND MANAGEMENT PROCESS

T2S Framework Agreement

Schedule 8 - Annex 2 - T2S deliverables list and management process

1. Document Scope and Objective

The objective of this document is to provide a baseline catalogue of T2S deliverables that are of interest for CSDs and CBs and that describes the scope of and the respective responsibilities for each deliverable. This catalogue defines a deliverable only once, even though there might be several versions and regular updates.

2. T2S Deliverables

2.1 Deliverable Specification

This annex provides a standardised definition of each T2S deliverable. The standardised definition documents not only a deliverable's purpose and scope, but also additional characteristics relating to responsibilities and Change Management.

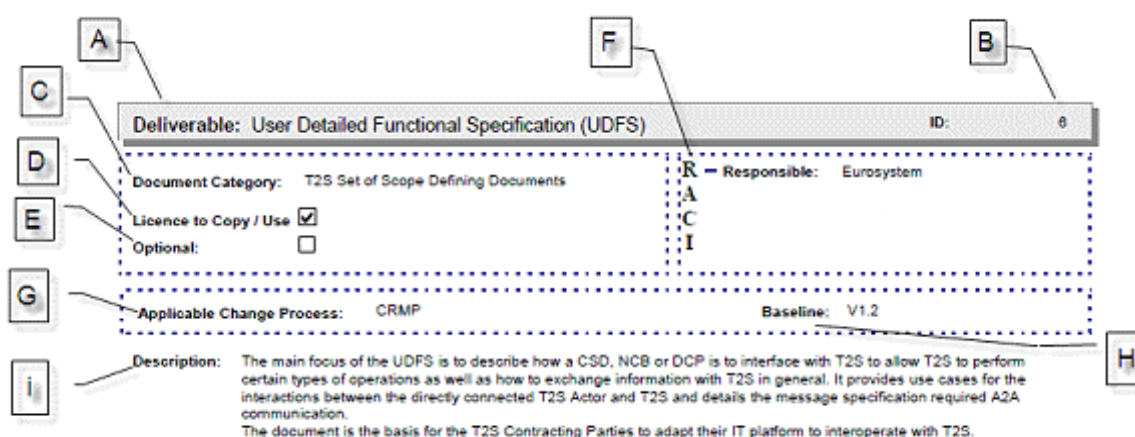

T2S Framework Agreement

Schedule 8 - Annex 2 - T2S deliverables list and management process

Label	Attribute Name	Description
A	Deliverable	This attribute documents the name of the deliverable.
B	ID	This attribute specifies the unique identifier of the deliverable.
C	Document Category	This attribute specifies the category of document to which the deliverable belongs (see below table in this annex).
D	License to Copy/Use	Each deliverable has an attribute that states who owns the Intellectual Property Rights and whether a licence to copy or use exists for the other parties as set out in the T2S FA (article 28) and T2S CPA (article 31).
E	Optional	This attribute specifies whether this deliverable is optional or mandatory. <u>Value</u> <u>Description</u> Ticked Optional Empty Mandatory
F	RACI	The attribute defines the responsibilities and accountabilities for a deliverable.
G	Applicable Change Management Process	This attribute specifies which Change Management process applies to the deliverable, e.g. <u>Value</u> <u>Description</u> CRMP Change and Release Management Process according to Schedule 9 of this agreement.
H	Baseline	The attribute specifies the version of the deliverable from which the Change Management process specified by the attribute “Applicable Change Management Process” applies.
i	Description	The attribute provides a short description of the scope and content of the deliverable.

2.2 Responsible, Accountable, Consulted, Informed (RACI)

2.2.1 Responsible

This classifier assigns to a deliverable *those who do the actual work* by specifying the entity, i.e. Eurosystem, CSD or CB, responsible for creating and maintaining the deliverable throughout its life cycle.

2.2.2 Accountable

This classifier assigns to a deliverable *those who are ultimately accountable for the completion of the work*. The body that is accountable is the approving body. The FA-CPA Agreement defines the body that is accountable for the legal documents and the T2S Scope Defining Set of Documents. Schedule 8 of this Agreement defines in its section “Decision-making on relevant matters other than Change Requests” the body that is accountable for all other deliverables.

T2S Framework Agreement

Schedule 8 - Annex 2 - T2S deliverables list and management process

For the purpose of the Annex, Deliverable List, the body mentioned will be the sub-structure that writes a recommendation to approve to the Steering Level.

2.2.3 Consulted

This classifier assigns to a deliverable *those who provide input* as needed by specifying whether or not the Party to the Agreement is consulted regarding the T2S deliverable. Consulted can mean written procedures or workshops. In case Change Request affects a deliverable, then the consultation also applies for subsequent updated versions.

Consulted refers to a formal process where the Responsible expects comments from other Parties to the Agreement (in particular CSDs and CBs). This means that the Responsible submits a DRAFT version and collects the comments. The Responsible analyses all comments and must:

- (a) consider the comments and/or produce a new version; or
- (b) explain why a comment has not been taken on board.

2.2.4 Informed

This classifier assigns to a deliverable *those who need to be kept up to date* on progress of the particular phase. The Responsible submits a proposal as regard the distribution list (bodies to be informed) to the Accountable body together with the draft document. Being informed might take the form of an early involvement.

2.3 Baseline

The Responsible produces the draft version that upon approval as described in the Section 3 becomes a 'Baseline' (with or without consultation of the other Party). A 'Baseline' serves as basis/reference for that deliverable. Each deliverable has an attribute that specifies the version number that will be considered as 'Baseline'. Any change to the baseline follows a formal change process, as defined thereafter. The latest baseline version of a deliverable must be easily identifiable.

2.4 Applicable Process per Document Type

Each deliverable has an attribute that specifies the applicable process for approving changes to the baseline – which is summarised in the table below. Some deliverables are not subject to any formal Change Management process. The deliverables subject to a Change Management

T2S Framework Agreement

Schedule 8 - Annex 2 - T2S deliverables list and management process

process are communicated either in a complete version (with revision marks if technically possible or with indication of a list of changes) or in an intermediate document (e.g. Document Change Notice) to avoid waiting for the next release of the deliverable. The modalities for communication are defined, on a case-by-case basis, in the course of the Change Management process.

T2S Framework Agreement

Schedule 8 - Annex 2 - T2S deliverables list and management process

Document Category	Description ¹	Initial Baseline number is indicated in	Substructure involved	Change Management Process	
Legal Acts	Means the FA / CPA and their respective schedules.	N/A	N/A	Specific FA / CPA Process	
T2S Scope Defining Set of Documents	Means the T2S Scope Defining Set of Documents as defined in Schedule 1.	The deliverables list	CRG	Change Request (Schedule 9)	
T2S Documentation	Other T2S Specification Documents	Means the set of documents which, when added to the T2S Scope Defining Set of Documents, provide a full description of T2S.	The deliverables list	CRG	Deliverable Change Process (described in this Annex) Unless otherwise specified in the list of deliverables
	T2S Operational Phase Documents	Means the set of documents that describes how T2S provides its services. It encompasses the documentation for T2S as a software application and the manuals describing the rules and procedures for operating T2S.	The deliverables list	OMG/ SMG (for IT security and Cyber Resilience)	Deliverable Change Process (described in this Annex) Unless otherwise specified in the list of deliverables
	T2S Release planning and monitoring documents	Means the set of documents required for planning, monitoring and successfully completing the scheduled activities (e.g. User Testing, Migration, client readiness tracking) during the preparation and testing of releases.	The deliverables list	PMG	Deliverable Change Process (described in this Annex) Unless otherwise specified in the list of deliverables

¹. As included in Schedule 1.

T2S Framework Agreement

Schedule 8 - Annex 2 - T2S deliverables list and management process

3. Deliverable Approval and Change Process

This section describes the approval and change process for deliverables which are neither subject to the FA/CPA Change Management process nor to the CRMP (Schedule 9).

3.1 High-Level Deliverable Approval Process – Creation of a Baseline

The following process applies for the approval of the first Baseline for each Deliverable:

Deliverable Approval process:

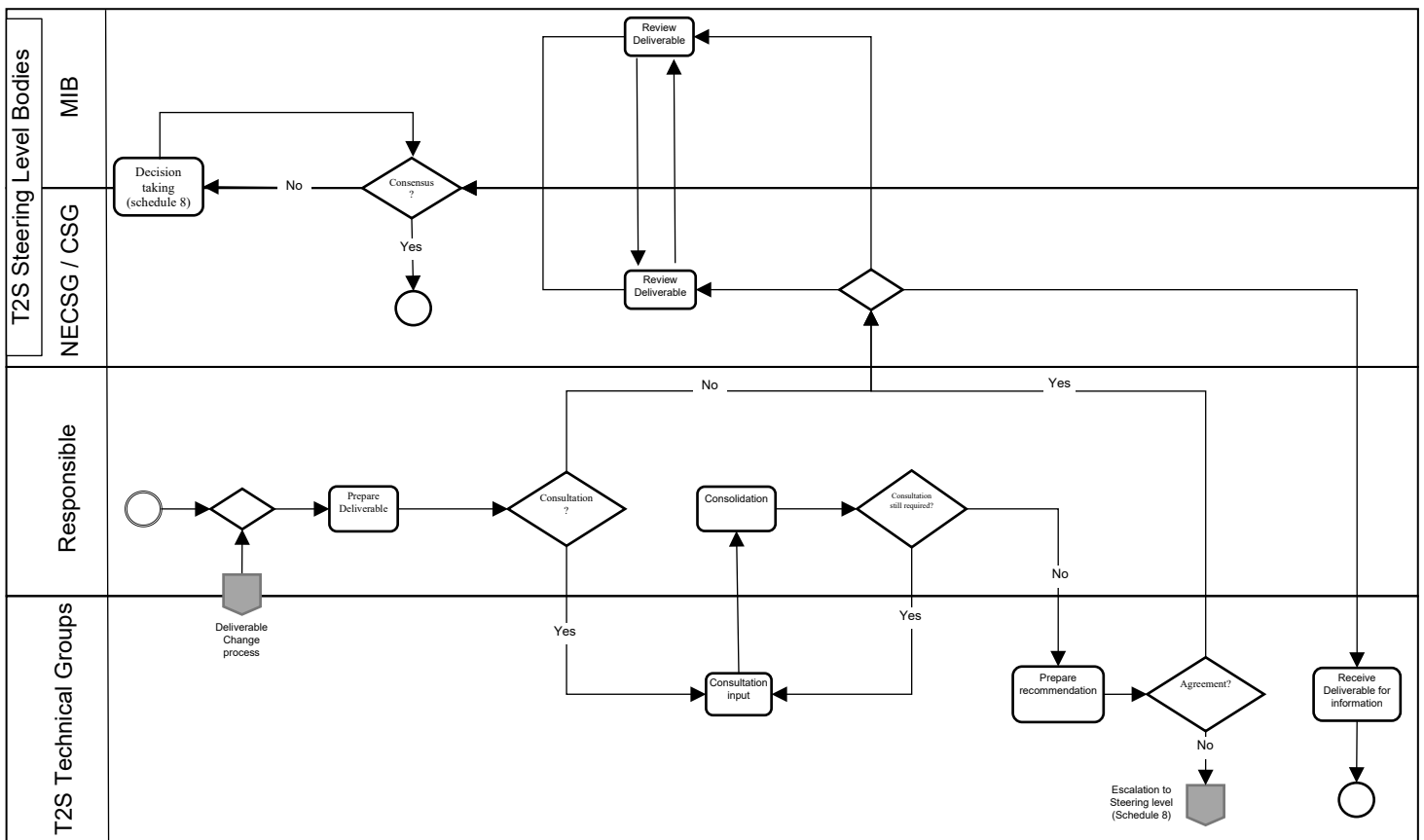

T2S Framework Agreement

Schedule 8 - Annex 2 - T2S deliverables list and management process

3.1.1 Process Actors and their Roles

Process Actor	Process Role
Responsible	As above defined.
Technical Groups <i>(one body only, depending on the deliverable category)</i>	In this process, the Responsible consults the Technical Groups. It is the responsibility of the consulted body to provide comments during the approval process and to proactively and in good faith try achieving agreement among its members.
CSG/NECSG	The T2S CSG/T2S NECSG is responsible for reviewing the Deliverable, taking into account the recommendations supplied by the Technical Groups and taking all necessary steps to reach a consensus at Steering Level.
MIB	The MIB is responsible for endorsing the Deliverable, taking into account the recommendations supplied by the Technical Groups and taking all necessary steps to reach a consensus at Steering Level. The MIB also coordinates the work at Steering Level to reach a consensus following the process described in Schedule 8, Section 1.3.

3.1.2 High-Level Process Description

This section provides an overview of the process for Baseline creation for deliverables.

The Responsible after drafting the deliverable and if applicable, sends the deliverable for consultation of other parties.

During consultation, in case of diverging views the Technical Groups members have the opportunity to inform the T2S CSG/T2S NECSG about their diverging views.

After consultation and in line with RACI information, the Responsible presents the deliverable for approval to the Steering Level. If consulted, the Technical Groups write a recommendation to approve. This recommendation is attached to the Deliverable submission to the Steering Level.

The Steering Level endorses the deliverable by consensus. The MIB coordinates the work at Steering Level to reach a consensus following the process described in Schedule 8, Section 1.3.

T2S Framework Agreement

Schedule 8 - Annex 2 - T2S deliverables list and management process

3.2 Deliverable Change Process – Updating a Baseline

Each deliverable has a specific Change Management process. This process is described either in the Schedule 9 – Change Request– or in this section. The below process applies to all deliverables for which the ‘Applicable Process’ clearly foresees ‘*Deliverable Change Process*’ as opposed to other value (e.g. Change Request).

Deliverable Change process:

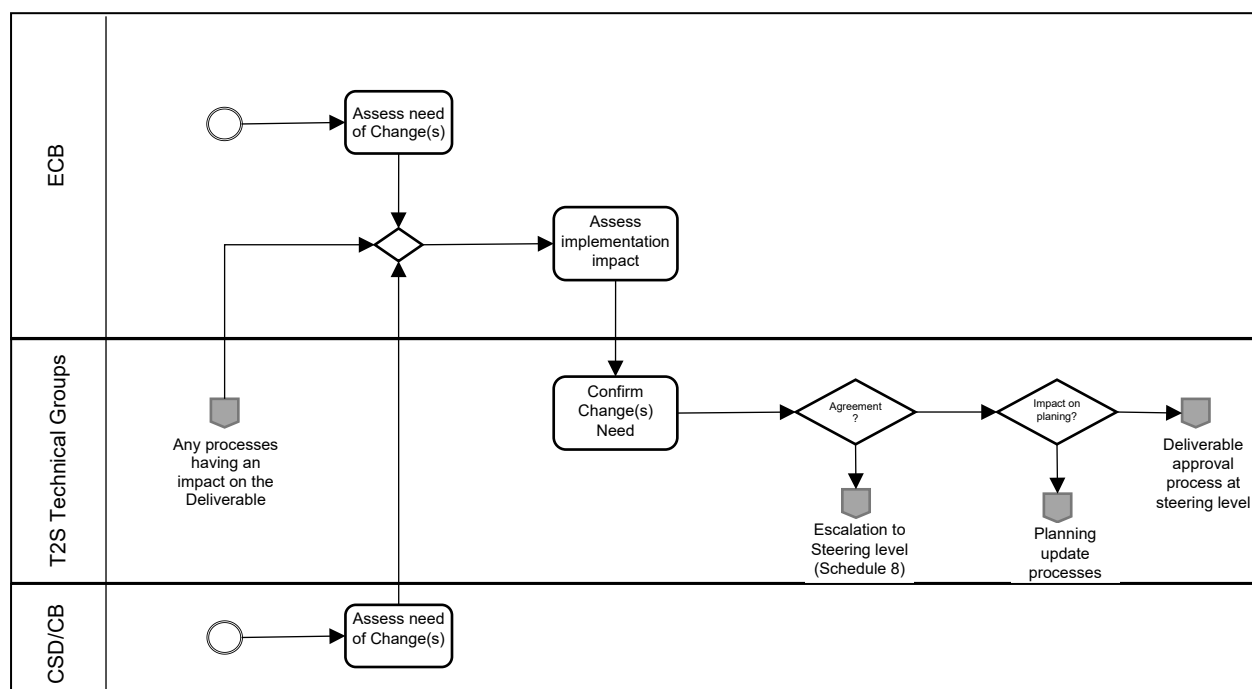

T2S Framework Agreement

Schedule 8 - Annex 2 - T2S deliverables list and management process

3.2.1 Process Actors and their Roles

Process Actor	Process Role
ECB	The ECB is in charge of: <ul style="list-style-type: none">▪ identifying, collecting and raising Change Requests (e.g. need to update due to another deliverable);▪ undertaking the assessment of changes requests;▪ communicating the results of the assessment to the Technical Groups; and▪ implementing the change when the Eurosystem is the Responsible.
Signatory CSD, CBs	The Signatory CSDs and/or CBs are in charge of: <ul style="list-style-type: none">▪ implementing the change when the Signatory CSDs and/or CBs are the Responsible; and▪ identifying and raising Change Requests, if relevant.
Technical Groups <i>(one body only, depending on the Deliverable)</i>	In this process, one technical Group is in charge of: <ul style="list-style-type: none">▪ reviewing and discussing the changes proposed to a deliverable;▪ confirming the need of the change or rejecting the proposal; and▪ in case of disagreement, escalation to the T2S CSG/T2S NECSG or MIB(in line with the section 7.4 Disagreement Resolution process in Schedule 2).

3.2.2 High Level Process Description

This section provides an overview of the process for Baseline update for deliverables.

The ECB/4CB and/or CSDs and/or CBs may wish to change a deliverable.

The ECB team collects the change(s) request. Thereafter, the ECB/4CB assess the change(s) request (including Planning impact assessment). The technical Group responsible for the deliverable reviews the change(s) request together with the ECB/4CB assessment.

After agreement on the change(s) at Technical Group level, the approval process at Steering Level should follow the initial approval process used to create the baseline (see section 3.1).

In case of disagreement, the Technical Group may initiate the disagreement resolution process to get agreement on the proposed change(s) (in line with the section 7.4 Disagreement Resolution process in Schedule 2).

T2S Framework Agreement

Schedule 8 - Annex 2 - T2S deliverables list and management process

4. List of Deliverables

Deliverable: User Requirements Document (URD)	
Document Category: T2S Scope Defining Set of Documents Licence to Copy / Use: <input checked="" type="checkbox"/> Optional: <input type="checkbox"/>	R – Responsible: Eurosystem A – Accountable: CRG C – Consultation: CSD, NCB I – Information: n/a
Applicable Change Process: CRMP	
Description:	In line with the Schedule 1 definition: 'means the latest available document setting out the User requirements for T2S Services as published by the ECB as subsequently amended through the Change and Re-lease Management process'. This document defines the requirements for the T2S Services..

Deliverable: General Functional Specification (GFS)	
Document Category: T2S Scope Defining Set of Documents Licence to Copy / Use: <input checked="" type="checkbox"/> Optional: <input type="checkbox"/>	R – Responsible: Eurosystem A – Accountable: CRG C – Consultation: CSD, NCB I – Information: n/a
Applicable Change Process: CRMP	
Description:	The specification documents the functional design of T2S and how the user requirements are implemented from a functional perspective.

Deliverable: User Detailed Functional Specification (UDFS)	
Document Category: T2S Scope Defining Set of Documents Licence to Copy / Use: <input checked="" type="checkbox"/> Optional: <input type="checkbox"/>	R – Responsible: Eurosystem A – Accountable: CRG C – Consultation: CSD, NCB I – Information: n/a
Applicable Change Process: CRMP	
Description:	This deliverable is the manual that describes how a T2S Actor can interface its software applications with T2S to enable T2S to execute certain types of operations and to exchange information with T2S. It provides use cases for the interactions between the Directly Connected T2S Actor and T2S and details the message specification required A2A communication. The UDFS also contains the specifications required in order to set-up and manage the direct connectivity with T2S. The document is the basis for adapting the IT platform to interoperate with T2S.

T2S Framework Agreement

Schedule 8 - Annex 2 - T2S deliverables list and management process

Deliverable: User Handbook (UHB)	
Document Category: T2S Scope Defining Set of Documents Licence to Copy / Use: <input checked="" type="checkbox"/> Optional: <input type="checkbox"/>	R – Responsible: Eurosystem A – Accountable: CRG C – Consultation: n/a I – Information: CSD, NCB
Applicable Change Process: CRMP	
Description:	The UHB describes the Graphical User Interface (GUI) of T2S, i.e. U2A communication. It is intended for the business user, who will interact with T2S for updating and querying data. It presents information on the application behaviour, window navigation, windows, fields and validation rules in order to explain how a user can perform specific operations in T2S through the GUI.

Deliverable: Graphical User Interface (GUI) Business Functionalities	
Document Category: T2S Scope Defining Set of Documents Licence to Copy / Use: <input checked="" type="checkbox"/> Optional: <input type="checkbox"/>	R – Responsible: Eurosystem A – Accountable: CRG C – Consultation: CSD, NCB I – Information: n/a
Applicable Change Process: CRMP	
Description:	The scope of this document is to provide the scope of business functions expected for the Graphical User Interface and to provide a brief description covering the purpose and key features of the business functions. It also depicts the framework for logical association of business functions applicable for a business object. (The framework diagrams in this document do not depict certain access features that are purely of technical nature like returning to the previous or exit from a function).

Deliverable: Manual of Operational Procedures (MOP)	
Document Category: T2S Operational Readiness Documents Licence to Copy / Use: <input checked="" type="checkbox"/> Optional: <input type="checkbox"/>	R – Responsible: Eurosystem A – Accountable: OMG C – Consultation: CSD, NCB I – Information: n/a
Applicable Change Process: Deliverable Change Process (OMG)	
Description:	This manual provides the detailed procedures to be followed by the T2S Actors (excl ICPs) and the Eurosystem to ensure the smooth functioning of T2S in normal as well as in contingency and exceptional situations (e.g. Disaster Recovery and Business Continuity).

T2S Framework Agreement

Schedule 8 - Annex 2 - T2S deliverables list and management process

Deliverable: T2S Compliance Guide for CSD Eligibility Criteria	
Document Category: T2S Documents Licence to Copy / Use: <input type="checkbox"/> Optional: <input type="checkbox"/>	R – Responsible: Eurosystem A – Accountable: Eurosystem C – Consultation: n/a I – Information: CSD, NCB
Applicable Change Process: n/a	
Description:	This deliverable documents and explains the conditions that CSDs must fulfil to participate in T2S. The 5 criteria to be respected are defined under article 4.3 of the Framework Agreement. Also see Deliverable ID 425 on "Proof of eligibility to participate in T2S".

Deliverable: Information Security Policy	
Document Category: Legal Acts Licence to Copy / Use: <input checked="" type="checkbox"/> Optional: <input type="checkbox"/>	R – Responsible: Eurosystem A – Accountable: Eurosystem C – Consultation: CSD, NCB I – Information: n/a
Applicable Change Process: n/a	
Description:	The Information Security Policy for T2S is a high-level document that defines the principle and scope of, allocation of responsibilities for and other relevant aspects of information security for T2S. This document is included in the Framework Agreement and in the Currency Participation Agreement (Schedule 10).

Deliverable: Eurosystem T2S Certification	
Document Category: T2S Documents Licence to Copy / Use: <input type="checkbox"/> Optional: <input type="checkbox"/>	R – Responsible: Eurosystem A – Accountable: Eurosystem C – Consultation: n/a I – Information: CSD, NCB
Applicable Change Process: n/a	
Description:	This deliverable is the assessment of the Eurosystem whether or not a CSD, an NCB or a DCP/DCAH has successfully completed its certification testing for this specific release of T2S. In case the assessment is negative, the Eurosystem formally documents the specific reason or reasons for its refusal to certify a T2S Actor for this specific release of T2S.

T2S Framework Agreement

Schedule 8 - Annex 2 - T2S deliverables list and management process

Deliverable: CSD/NCB/DCP Certification Report	
Document Category: T2S Release planning and monitoring Documents Licence to Copy / Use: <input type="checkbox"/> Optional: <input type="checkbox"/>	R – Responsible: CSD/ NCB/ DCP A – Accountable: CSD/ NCB/ DCP C – Consultation: n/a I – Information: Eurosystem
Applicable Change Process: Deliverable Change Process (PMG)	
Description:	As defined in the Framework Agreement/Currency Participation Agreement Schedule 3-User Testing pt. 5.4.5 on Certification; The CSDs/CBs/DCPs shall submit for validating the test results a final report providing evidence of the successful completion of the relevant certification test cases to the Eurosystem. This report will document the results in the certification completion presenting at the minimum the number of test cases and test scenarios successfully executed and failed. As indicated the T2S Compliance Guide Annexes.

Deliverable: ECB/2011/20 `Decision establishing rules and procedures for implementing the eligibility criteria for central securities depositories to access T2S services`	
Document Category: T2S Documents Licence to Copy / Use: <input type="checkbox"/> Optional: <input type="checkbox"/>	R – Responsible: Eurosystem A – Accountable: Eurosystem C – Consultation: n/a I – Information: CSD, NCB a
Applicable Change Process:	n/a
Description:	<p>The ECB Decision establishing rules and procedures for implementing the eligibility criteria for central securities depositories to access T2S services (ECB/2011/20), was adopted on 16 November 2011 by the Governing Council. The ECB Decision is largely based on the Implementation Guide for CSD Eligibility Criteria, endorsed by the T2S Programme Board in December 2010. In substance, the eligibility criteria were already incorporated in Article 15 of Guideline BCE/2010/2 on TARGET2-Securities and have been reflected also in the Framework Agreement.</p> <p>The ECB Decision contains rules and procedures regarding the CSD application to access T2S Services, which is granted by the Governing Council if all criteria are met, and regarding the control of the on-going compliance of such CSD with the same eligibility criteria. It also contains procedures to regulate the derogation from access criterion 5.</p> <p>The importance of the adoption of an ECB Decision containing the eligibility criteria is that it permits a greater transparency, procedural consistency as well as legal certainty, ensuring level-playing-field among CSDs. Moreover, it allows control over the derogation regime from compliance with access criterion 5.</p>

T2S Framework Agreement

Schedule 8 - Annex 2 - T2S deliverables list and management process

Deliverable: Training Materials	
Document Category: T2S Release planning and monitoring Documents Licence to Copy / Use: <input checked="" type="checkbox"/> Optional: <input type="checkbox"/>	R – Responsible: Eurosystem A – Accountable: Eurosystem C – Consultation: n/a I – Information: CSD, NCB
Applicable Change Process: Deliverable Change Process (PMG)	
Description:	The Eurosystem provides the CSDs/NCBs with training on a train-the-trainer basis. If requested by a CSD/ NCB, the Eurosystem can also provide these trainings (train the trainer concept) to the CSD/NCB customers. These training materials are in line with internal documents such as the T2S Training Framework and Training material guidelines. This document is delivered by topic: Basic, Technical, Functional, Operational, Testing and Migration. The plan details the versioning and delivery dates for each topic.

Deliverable: Operations Related Test Scenarios	
Document Category: T2S Operational Readiness Documents Licence to Copy / Use: <input type="checkbox"/> Optional: <input type="checkbox"/>	R – Responsible: Eurosystem A – Accountable: OMG C – Consultation: CSD, NCB I – Information: PMG, UTSG
Applicable Change Process: Deliverable Change Process (OMG)	
Description:	A step-by-step description of test scenarios, specifying the pre-requisites, expected results, details on timing aspects and involvement of the T2S community.

Deliverable: T2S Operational Directory (incl. T2S-info)	
Document Category: T2S Operational Readiness Documents Licence to Copy / Use: <input type="checkbox"/> Optional: <input type="checkbox"/>	R – Responsible: Eurosystem A – Accountable: OMG C – Consultation: CSD, NCB, ECB I – Information: n/a
Applicable Change Process: Deliverable Change Process (OMG)	
Description:	A supporting tool for the smooth communication between T2S Actors (incl. DCPs and excl. ICPs), including up-to date contact information and communication templates.

T2S Framework Agreement

Schedule 8 - Annex 2 - T2S deliverables list and management process

Deliverable: CSD application to access T2S services including T2S Eligibility Criteria Report	
Document Category: T2S new joiners Documents Licence to Copy / Use: <input type="checkbox"/> Optional: <input type="checkbox"/>	R – Responsible: CSD A – Accountable: CSD C – Consultation: Eurosystem (CRM) I – Information: n/a
Applicable Change Process: Deliverable Change Process (PMG)	
Description:	This document is the standardised form that CSDs must complete for CSDs to document their compliance with the Eligibility Criteria for Participation in T2S as defined in the deliverable 41: ECB/2011/20 'Decision establishing rules and procedures for implementing the eligibility criteria for central securities depositories to access T2S services'. As described in the T2S Compliance Guide.

Deliverable: CSD Feasibility Assessment	
Document Category: T2S new joiners Documents Licence to Copy / Use: <input type="checkbox"/> Optional: <input type="checkbox"/>	R – Responsible: CSD A – Accountable: CSD C – Consultation: Eurosystem (CRM) I – Information: Eurosystem
Applicable Change Process: n/a	
Description:	This deliverable presents the results of the CSD feasibility assessment. It contains a view on their internal adaptation approach and planning. It also presents the efforts the CSD is going to undertake to coordinate the readiness of their clients. As part of this feasibility assessment, CSD will also list the identified showstoppers, including the mitigating measures taken, and the date at which they could potentially migrate (individual date).

Deliverable: CB Feasibility Assessment	
Document Category: T2S new joiners Documents Licence to Copy / Use: <input type="checkbox"/> Optional: <input type="checkbox"/>	R – Responsible: NCB A – Accountable: NCB C – Consultation: Eurosystem (CRM) I – Information: Eurosystem
Applicable Change Process: n/a	
Description:	This deliverable presents the results of the CB feasibility assessment. It contains a view on their internal adaptation approach and planning. It also presents the efforts the CB is going to undertake to coordinate the readiness of their clients. As part of this feasibility assessment, CB will also list the identified showstoppers, including the mitigating measures taken, and the date at which they could potentially migrate (individual date).

T2S Framework Agreement

Schedule 8 - Annex 2 - T2S deliverables list and management process

Deliverable: T2S Operational Governance Process Framework	
Document Category: T2S Release planning and monitoring Documents Licence to Copy / Use: <input type="checkbox"/> Optional: <input type="checkbox"/>	R – Responsible: Eurosystem A – Accountable: OMG/PMG/CRG C – Consultation: CSD/ CB I – Information: n/a
Applicable Change Process: Deliverable Change Process (OMG/PMG/CRG)	
Description:	<p>This document aims at clarifying the break-down of operational process such as Change , Release and Deployment Management as well as Service Valuation and Testing as well as the high-level process descriptions for decision-taking in these processes, based on compliance with existing legal contractual and regulatory obligations achieved on project and operational topics in various governance groups, subgroups and workshops.</p> <p>This framework details the implementation of change, release and deployment management, as defined in the Framework Agreement and the Currency Participation Agreement, as operational processes that document the tasks and interactions of the Operational Managers Group (OMG), Project Managers Group (PMG), Change Review Group (CRG) and the Eurosystem as Service Provider.</p>

Deliverable: User Testing Terms of Reference	
Document Category: T2S Release planning and monitoring Documents Licence to Copy / Use: <input checked="" type="checkbox"/> Optional: <input type="checkbox"/>	R – Responsible: Eurosystem A – Accountable: PMG C – Consultation: CSD, NCB I – Information: n/a
Applicable Change Process: Deliverable Change Process (PMG)	
Description:	<p>The User Testing Terms of Reference is a generic document which outlines the principles for the organisation and structure of the testing activities (including. release testing and user testing activities required for new joiners).</p> <p>It focuses on the scope and content of the testing activities and the services provided for the execution of the tests. The User Testing Terms of Reference will include further annexes which will provide further information or templates used for reporting progress.</p>

Deliverable: Migration and User Testing Strategy (by Entity)	
Document Category: T2S release planning and monitoring Documents Licence to Copy / Use: <input checked="" type="checkbox"/> Optional: <input type="checkbox"/>	R – Responsible: Eurosystem A – Accountable: PMG C – Consultation: CSD, NCB I – Information: n/a
Applicable Change Process: Deliverable Change Process (PMG)	
Description:	<p>This strategy document describes all migration and testing activities to be performed by a given new joiner, including migration fall back procedures where relevant, to ensure a smooth migration to T2S.</p> <p>The document will be complemented with a list of annexes which would further detail the specific activities to be included, their sequence and respective schedule.</p>

Deliverable: T2S operational risk management CSD information and contributions	
Document Category: T2S Documents Licence to Copy / Use: <input checked="" type="checkbox"/>	R – Responsible: Eurosystem A – Accountable: RMCG C – Consultation: CSD/ CB I – Information: n/a

T2S Framework Agreement

Schedule 8 - Annex 2 - T2S deliverables list and management process

Optional: <input type="checkbox"/>	
Applicable Change Process: RMCG deliverable	
Description:	This document covers the involvement of the Signatory CSDs in the T2S operational risk management. It describes the Signatory CSD contributions to the T2S operational risk management and the information sharing principles.

Deliverable: Data Migration Tool File Specifications	
Document Category: T2S Scope Defining Set of Documents	R – Responsible: Eurosystem
Licence to Copy / Use: <input checked="" type="checkbox"/>	A – Accountable: CRG
Optional: <input type="checkbox"/>	C – Consultation: CSD/ CB
Applicable Change Process: CRMP	I – Information: n/a
Description:	Prior to their going-live the Data Migration Tool (DMT) offers CSDs and NCBs the opportunity to load bulk reference and dynamic data into T2S. The data is located in Excel or in flat files that are created by the user and submitted to T2S via a web application. The Excel files are used by a human being that manually transfers the data into the spreadsheet whereas the flat files are used by a legacy application that automatically exports the data into the file



EUROPEAN CENTRAL BANK

EUROSYSTEM

T2S FRAMEWORK AGREEMENT

SCHEDULE 08

ANNEX 03 - JOINT CONTROLLERSHIP ARRANGEMENT

*ARRANGEMENT ON JOINT CONTROLLERSHIP FOR THE
PROCESSING OF PERSONAL DATA IN THE CONTEXT OF T2S*

T2S Framework Agreement

Schedule 08 - Annex 03 – Joint Controllership Arrangement

1. Introduction

For the purpose of processing personal data in T2S, the ECB, the euro area NCBs and, as the case may be, a non-euro area NCB in T2S or a Signatory CSD are deemed to be joint controllers in the meaning of Article 28 of the EUDPR and Article 26 of the GDPR. Several joint controllerships exist, all of them comprising (i) the ECB, (ii) the euro area NCBs, and (iii) a non-euro area NCB in T2S or a Signatory CSD, as the case may be. Information on personal data and data subjects exercising their rights should only be shared within the respective joint controllership.

For the purpose of this Agreement, the ECB, the euro area NCBs, and the Contracting CSD (in this Annex altogether referred to as ‘the Joint Controllers’) are deemed to be joint controllers in the meaning of Article 28 of the EUDPR and Article 26 of the GDPR.

This Annex together with the relevant sections of the MOP governs the respective roles and responsibilities of the Joint Controllers resulting from the EUDPR and the GDPR.

2. Purpose and description of the processing of personal data in T2S

I. Purpose of processing

T2S processes personal data only for the limited purpose of providing the security settlement service in central bank money to Signatory CSDs. Personal data are processed in T2S for the purpose of user authentication and identification for authorised personnel.

II. Description of processing

- a. Personal data are processed in T2S with regards to the Natural Persons T2S System Users, as defined under section 4.1(ii) of this Schedule. The Natural Person T2S System Users need a USB token that contains the digital certificate and its distinguished name. This token is provided by the authorised telecommunication service providers appointed for the T2S connection services.

In relation to CSD Reference Data, it is possible to associate a Natural Person T2S System User with more than one DN Certificate and a DN Certificate with more than one Natural Person T2S System User. In this way the same USB token can be used to identify several distinct users, but associated with the same certificate DN.

- b. T2S does not require personal data for the settlement of transactions. However, personal data might be processed by T2S in the event that they are included as part of a transaction message from a CSD or from a CSD’s Directly Connected Party (DCP), that is intended for settlement in T2S and transmitted by a CSD or its DCPs. When T2S performs the validation process in order to ensure the consistency between the instruction received and the T2S reference data, it does not consider or assess personal data therein.

Further information regarding the processing of data by T2S is provided in the T2S Scope Defining Set of Documents.

T2S Framework Agreement

Schedule 08 - Annex 03 – Joint Controllership Arrangement

3. Legal basis

- **For the euro area NCBs and the ECB:**

Article 6(1)(e) of the GDPR in the case of the euro area NCBs, and Article 5(1)(a) of the EUDPR in the case of the ECB (i.e. the processing is necessary for the performance of a task carried out in the public interest), pursuant to Articles 17 and 22 of the Statute of the ESCB (i.e. mandate to ensure efficient and sound clearing and payments systems within the Union and with other countries).

- **For the Signatory CSDs:**

Article 6(1)(b) of the GDPR (i.e. the processing is necessary for the performance of a contract to which the data subject is party) and Article 6(1)(f) of the GDPR (i.e. legitimate interests pursued by the controller).

4. Data subjects. Description of personal data processed in T2S

I. Data Subjects

T2S processes or may process, as applicable, a limited set of personal data with regards to two types of data subjects:

- (i) **Natural Person T2S System User** which, for the purpose of this document, refers to an individual (mandated by any of the Joint Controllers) that can access the T2S services using a login name and password; and
- (ii) **Other data subjects whose personal information might be transmitted by a Signatory CSD or its DCP participants** to T2S as part of a transaction message submitted for settlement in T2S.

II. Personal data processed in T2S

- (i) **Processing of personal data of Natural Person T2S System Users**

A Natural Person T2S System User interacts with T2S in U2A mode via the T2S GUI. Access rights are granted or revoked to a Natural Person T2S System User based on privileges. A Natural Person T2S System User's access profile is defined by the set of roles (composed of privileges) assigned to the profile.

Each Natural Person T2S System User is identified in T2S by:

- A unique reference (System User Reference - SUR)
- A DN digital certificate (Distinguished Name Certificate), which is an electronic document associating the identity of a T2S user to a pair of cryptographic keys.
- A clear link to an existing participant (Parent BIC / BIC)
- A unique login name (Login Name).

The Natural Person T2S System Users need a USB token that contains the digital certificate and its distinguished name. This token is provided by the authorised telecommunication service providers appointed for the T2S connection services.

T2S Framework Agreement

Schedule 08 - Annex 03 – Joint Controllership Arrangement

In T2S reference data, it is possible to associate a Natural Person T2S System User with more than one DN Certificate and a DN Certificate with more than one Natural Person T2S System User. In this way the same USB token can be used to identify several distinct users, but associated with the same certificate DN.

(ii) Processing of personal data of other data subjects included in the free format fields

Personal data of other data subjects are not required for the settlement services of T2S.

The ISO message format used for settlement services in T2S includes free format fields. Therefore, personal data of other data subjects might be included in such a free format field of a settlement transaction, and subsequently be received by T2S. Only personal data included in free text fields that is not collected or transmitted for the Signatory CSD's own purposes (see iii. below) falls into the scope of the joint controllership.

The categories of personal data cannot be specified, because the free format fields are not monitored, and are not accessible via the T2S GUI.

(iii) Processing of personal data of other data subjects included in the free format fields for purposes of CSD's

For the avoidance of doubt: Personal data may be collected or transmitted for the Signatory CSD's own purposes and by their own means, such as avoiding cross-matching or portfolio transfers. This personal data is out of scope of the joint controllership and the respective Signatory CSD is considered to be the sole controller.

5. Technical/organisational security measures according to the principles defined in the specific service solution documentation

T2S personal data are processed in T2S in accordance with the T2S Scope Defining Set of Documents. The T2S record of processing activities provide further information on the types of personal data, their location in the system and the protection methods that the T2S Operators apply on behalf of the T2S Joint Controllers.

The relevant sections of the MOP further details the technical and organisational security measures.

6. Retention time

The Signatory CSD shall keep all its records on the services and activities as set out by Article 29 of Regulation (EU) No 909/2014 (CSDR).

As set out in chapter 9.5 of Schedule 5 (Archiving services) of this Agreement, T2S status and transactional data are archived for a retention period of 10 years for legal evidence, billing, and fiscal purposes from the moment the transaction is processed.

T2S Framework Agreement

Schedule 08 - Annex 03 – Joint Controllership Arrangement

7. Allocation of responsibilities

- (i) Each Joint Controller is responsible in relation to the personal data which this respective Joint Controller transmits to T2S. This includes the obligation to deal with data subjects exercising their right and the processing of personal data breaches.
- (ii) In the event a Joint Controller assigns to data processors the processing of T2S operations, in the scope of the tasks such Joint Controller assumes under this arrangement, the referred Joint Controller will remain responsible for the compliance of the obligations set out in the EUDPR and the GDPR, as the case may be. In particular, Joint Controllers acknowledge that the involvement of data processors requires the conclusion of a contract as set out in Article 29(3) of the EUDPR and in Article 28(3) of the GDPR.

The Parties are entitled to use processors in connection with the joint processing of personal data, without the consent of the other Party. If a Party decides to use a new data processor, it shall inform the other Party without delay about the use of each data processors and any sub-data processors.

Any transfer of personal data outside the EEA will need to comply with the requirements set out in the GDPR/EUDPR. For the transfer of personal data to a third country (i.e. a country outside EU/EEA which is not covered by an adequacy decision of the European Commission) by a processor, the Party engaging the processor is responsible for ensuring a valid transfer basis.

The responsibilities of the Joint Controllers are further allocated as follows:

T2S Framework Agreement

Schedule 08 - Annex 03 – Joint Controllership Arrangement

Task	Joint Controller	
	Signatory CSD	The Eurosystem
Collection of data	<p>The Signatory CSD undertakes to make their best efforts to avoid that personal data of other data subjects (Section 2.II.b/4.II.(ii) of this Annex) is collected or transmitted to T2S. The Signatory CSD assumes all responsibilities arising from this processing in the terms referred in Section 7 above.</p> <p>The Signatory CSD determines which Signatory CSD employees shall be registered as Natural Person T2S System Users and their access rights to T2S, as provided for in the T2S Scope Defining Set of Documents.</p> <p>The Signatory CSD ensures appropriate processing by its T2S Directly Connected Participants (DCPs) as provided for in the T2S Scope Defining Set of Documents in the terms referred to in Article 8.2 of the T2S Framework Agreement.</p>	<p>Each euro area NCB and the ECB undertake to make their best efforts to avoid that personal data of other data subjects (Section 2.II.b/4.II.(ii) of this Annex) is collected or transmitted to T2S.</p> <p>Each euro area NCB and the ECB determine which of its employees shall be registered as Natural Person T2S System Users to operate in the name of their respective institutions as well as their access rights to T2S., in accordance with the User Detailed Functional Specifications (UDFS).</p> <p>The T2S Operators (Banca d'Italia, Banco de España, Banque de France and Deutsche Bundesbank) are responsible for the implementation of CSDs' and DCPs' authorised T2S users in T2S, as provided for in the T2S Scope Defining Set of Documents.</p>
Identify and define the categories of individuals to whom access to the personal data may be granted.	<p>The Signatory CSD is responsible for the definition of its own employee requirements and the appointment of its own Natural Person T2S System Users.</p>	<p>Each euro area NCB and the ECB is responsible for the definition of its own employee requirements and the appointment of its own Natural Person T2S System Users.</p>
Put adequate safeguards in place to ensure the security	<p>The Signatory CSDs is responsible for setting-up all appropriate safeguards, applying the proportionality principle, and</p>	<p>Each euro area NCB and the ECB is responsible for the operations conducted by the T2S Operators in T2S, notwithstanding that the 4CB shall also</p>

T2S Framework Agreement

Schedule 08 - Annex 03 – Joint Controllership Arrangement

<p>and confidentiality of the personal data.</p>	<p>to ensure the security and confidentiality related to the processing of personal data.</p>	<p>implement adequate and proportional safeguards, also ensuring the security and confidentiality of personal data.</p> <p>The above safeguards shall ensure personal data are safely archived and protected.</p>
<p>Define and implement the means to enable data subjects to exercise their rights in accordance with the Regulation (EU) No 2018/1725 or the GDPR</p>	<p>The Signatory CSD is responsible for defining its local procedures to support data subjects wishing to exercise their rights and to handle these requests in line with the relevant procedures described in the relevant sections of the MOP.</p>	<p>Each euro area NCB and the ECB is responsible for defining its local procedures to support data subjects wishing to exercise their rights and to handle these requests in line with the relevant procedures described in the relevant sections of the MOP.</p>
<p>Provide the data subject with information required under Articles 13, 14 and 26(2) of the GDPR or Articles 15, 16 and 28(2) of the Regulation (EU) No 2018/1725.</p>	<p>The Signatory CSD is responsible for making sure its respective employees are informed of said privacy statement prior to their registration in the T2S.</p>	<p>The Eurosystem shall publish a privacy statement on the ECB's website explaining the processing of personal data in T2S.</p> <p>Each euro area NCB and the ECB are responsible for making sure their respective employees are informed of said privacy statement prior to their registration in the T2S.</p>
<p>Single contact point for data subjects, including when they exercise their rights.</p>	<p>The Signatory CSD's Natural Person T2S System Users shall channel any petition to exercise their data protection rights through their employer Signatory CSDs.</p> <p>The Signatory CSD shall make available a single point of contact where data subjects whose data is included in the Signatory CSDs instructions can exercise their rights.</p>	<p>Each euro area NCB and the ECB shall define a single contact point for data subjects, including when they exercise their rights.</p> <p>The T2S Service desk is the single contact point for Joint Controllers requiring support to manage personal data enquiries from data subjects when they exercise their rights.</p>

T2S Framework Agreement

Schedule 08 - Annex 03 – Joint Controllership Arrangement

Administer any request of data subjects (such as requests for a copy of the personal data processed, rectification, for portability, erasure) and respond to them.	The Signatory CSD is primarily responsible for administering and responding to requests of data subjects in line with the relevant procedure described in the relevant sections of the MOP.	Each euro area NCB and the ECB is responsible for administering and responding to requests of data subjects in line with the relevant procedure described in the relevant sections of the MOP.
Lead the procedure in cases of personal data breach incidents / communicate the personal data breach to the data subjects or relevant data protection authorities, in case it is required by the EUDPR or the GDPR	<p>The Signatory CSDs is responsible for processing personal data breaches deriving from the transmission of personal data referred to in Section 4.2(ii) in accordance with its internally defined procedures, being responsible for any interaction with them or the supervisory authorities.</p> <p>The Signatory CSDs shall communicate without delay to the T2S Service Desk, as described in the relevant sections of the MOP, any personal data breach incident in its system potentially affecting personal data processing in T2S</p>	<p>The T2S Operators lead the detection and remediation of personal data breaches that take place in the T2S platform in accordance with the procedure set out in the relevant sections of the MOP.</p> <p>The Eurosystem shall cooperate with the Signatory CSDs to assist them in the processing of personal data breaches under their responsibility, following the procedures stated the relevant sections of the MOP.</p>



EUROPEAN CENTRAL BANK

EUROSYSTEM

T2S FRAMEWORK AGREEMENT

SCHEDULE 9

CHANGE AND RELEASE MANAGEMENT

T2S Framework Agreement

Schedule 9 – Change and Release Management

Table of contents

- INTRODUCTION..... 4**
- 1 OBJECTIVES 5**
- 2 SCOPE..... 6**
- 3 ENTITIES INVOLVED IN THE CRM PROCESS..... 8**
 - 3.1 TECHNICAL LEVEL..... 8
 - 3.1.1 ECB..... 8
 - 3.1.2 4CB 8
 - 3.1.3 Signatory CSDs and the Central Banks..... 9
 - 3.1.4 Change Review Group (CRG) 9
 - 3.1.5 Project Managers Group (PMG)..... 9
 - 3.1.6 Operations Managers Group (OMG)..... 10
 - 3.2 STEERING LEVEL 10
- 4 DECISION-MAKING PROCESS ON CHANGE REQUESTS 10**
- 5 CHANGE REQUEST MANAGEMENT 13**
 - 5.1 CATEGORISATION OF CHANGE REQUESTS..... 13
 - 5.1.1 Changes driven by Legal and Regulatory Requirements 13
 - 5.1.2 Type of change according to urgency..... 14
 - 5.1.3 Type of change according to beneficiary..... 14
 - 5.1.4 Parameters of changes..... 15
 - 5.1.4.1 Parameter 1: Legal/business importance..... 15
 - 5.1.4.2 Parameter 2: Market implementation efforts..... 16
 - 5.1.4.3 Parameter 3: Operational/technical impact..... 17
 - 5.1.4.4 Parameter 4: Financial impact for T2S 17
 - 5.2 CHANGE MANAGEMENT PROCESS 19
 - 5.2.1 Change Request Initiation and Registration..... 19
 - 5.2.2 Preliminary assessment..... 20
 - 5.2.3 Authorisation..... 21
- 6 RELEASE MANAGEMENT 22**
 - 6.1 RELEASE TYPES AND FREQUENCY 22
 - 6.2 RELEASE MANAGEMENT PROCESS 23
 - 6.2.1 Ranking of Change Requests and prioritisation of production problems..... 23
 - 6.2.2 Definition of release..... 24
 - 6.2.3 Release baselining..... 25

T2S Framework Agreement

Schedule 9 – Change and Release Management

- 6.2.4 *Release monitoring*..... 25
- 6.2.5 *Implementation*..... 26
- 6.2.5.1 *Design, building and configuration* 27
- 6.2.5.2 *Testing of a new release by the Signatory CSDs and the CBs*..... 27
- 6.2.5.3 *Roll- out and communication*..... 29
- 6.2.5.4 *Delivery – Go-live*..... 30
- 6.2.6 *Post implementation review*..... 30
- 7 T2S ISSUE MANAGEMENT 31**

Annex 1- Change Request Form

Annex 2 - Change Request Status

T2S Framework Agreement

Schedule 9 – Change and Release Management

Introduction

There are changes in T2S for a variety of reasons. Due to the fact that these changes need to be translated in a timely and consistent way into functional, legal, operational or technical specifications, with the involvement of (and impact on) all relevant T2S Stakeholders, a proper Change and Release Management process (CRM) must be defined and implemented. The CRM process is thus essential in order to efficiently track and manage changes to T2S and to mitigate the risks associated with these changes.

The definition of a release shall follow a demand driven model. This means that a priority rating is used to establish the order in which the authorised changes should be considered for a particular T2S release. In determining the priority rating, the available capacity and the resources for implementing the change must be taken into consideration. The CRM process is based on the ITIL (Information Technology Infrastructure Library) framework for IT service management.

The Eurosystem, the Signatory CSDs and the non-euro area NCBs in T2S shall be entitled to participate in the CRM process as full members of the Technical Groups in accordance with the T2S Governance. User representatives participate in the CRG as observers.

1 Objectives

The objectives of the CRM process are to:

- Respond to the relevant T2S Stakeholders' changing business requirements while maximising value and minimising the risk of change related Incidents;
- Ensure that Change Requests falling within the scope of this document shall be managed within the Lean Scope of T2S;
- Ensure that Change Requests are managed in an efficient and controlled manner from the initiation until implementation (recorded and then evaluated, authorized, and that the resulting changes are prioritised, planned, tested, implemented, documented and reviewed in a controlled manner);
- Ensure that Change Requests falling within the scope of this document are communicated to all relevant T2S Stakeholders in accordance with the rules laid down in this Schedule and in Schedule 8 (Governance);
- Agree on the exact T2S release content and plan the successful rollout of a release into the production environment; and
- Ensure that all changes are traceable, secure and that only correct, authorised and tested versions are installed on the T2S production environment.

T2S Framework Agreement

Schedule 9 – Change and Release Management

2 Scope

The CRM process applies to

- all functional changes which trigger any addition to, deletion from or modification of any item in T2S as defined in the T2S Scope Defining Set of Documents¹, as well as to changes to these documents, even if they do not have an impact on the T2S functionality;
- the requirements to be fulfilled by NSPs, as laid down in – and taking into account the provisions of – the Concession Contract; and
- non-functional changes that affect T2S functionality: they are modifications to the technical platform on which T2S operates, or to the T2S software that do not change the functionality, but their implementation potentially impacts the interoperability and services of CSDs, Central Banks and/or Directly Connected Parties (DCPs). An example for this category of change would be an upgrade of the database software that would require testing by CSDs and Central Banks prior to its implementation in production.

The General Principles of T2S in Section 1.2 of the User Requirements Document cannot be changed as a by-product of another Change Request, but only by a separate Change Request to the General Principles of T2S, which follows the decision-making process in this Schedule and respecting the Eurosystem rights as described in Schedule 8 (Governance). If any other Change Request falling within the scope of this Schedule is not in line with the General Principles of T2S as they read from time to time in the User Requirements Document, the CRG shall immediately report such inconsistency to the T2S Steering Level and wait for guidance before continuing the assessment of that Change Request.

Any change subject to the CRM process must be undertaken following the process outlined in this document.

Corrections/changes covered by maintenance activities for fixing errors, mistakes, failures or faults in the software system, which produce an incorrect or unexpected result, or cause it to behave in unintended ways (e.g. fixing errors in coding, design or detailed specification, performing changes to the system caused by an Incident/problem) shall be managed according to the procedures defined in the Manual of Operational Procedures. However, although these corrections/changes do not need assessment and authorisation in the context of Change Management process, they follow the Release Management process as described in chapter 5.2.

¹ The T2S Scope Defining Set of Documents as defined in the Schedule 1 (Definitions) to the T2S FA and the T2S CPA.

T2S Framework Agreement

Schedule 9 – Change and Release Management

The following changes are not subject to the CRM process:

- Technical changes to hardware/infrastructure components (i.e. non-functional changes without impact on the T2S functionality) under the control of the Eurosystem that are necessary to sustain the daily operation of T2S in accordance with the Service Levels specified in Schedule 6 (T2S Service Level Agreement). The respective arrangements/procedures for handling these changes are covered in Schedule 6 Annex 1 (Management of non-functional changes) and shall be detailed in the Manual of Operational Procedures. The Operations Managers Group, responsible for managing and implementing the technical changes, should liaise closely with the other Technical Groups to ensure a smooth implementation, in particular in case of technical changes that may have an impact on the service delivered (based on the risk assessment);
- Business configuration changes related to market parameters that can be done by the Signatory CSDs²/ CBs in accordance with the procedures defined in the Manual of Operational Procedures;
- Changes related to non-functional and non-technical documentation (e.g. Manual of Operational Procedures, Registration and Connectivity Guides, training materials, etc);
- Updates of the baseline version of other T2S specification documents and T2S Operational Phase documents³, which follow a Deliverable Change Process. The process and the substructure involved are defined in Schedule 8 Annex 2 (T2S Deliverables list and management process) to the T2S FA and T2S CPA.; and
- Other changes related to the T2S FA and its annexes, and to the T2S CPA and its annexes that shall be managed according to the relevant procedure as set out in the T2S FA, respectively the T2S CPA or the relevant annex following the applicable Governance regime.

² In accordance with the Preamble 3 of the T2S Framework Agreement, the Signatory CSDs shall retain full control of the parameter of its business operations. This applies e.g. for Signatory CSDs for setting up the T2S Securities Accounts for their customers including all needed access rules, granting of access privileges, etc. Setting up of these parameters and rules should be done according to the best market practices and the relevant regulatory requirements.

³ Other T2S specification documents and T2S Operational Phase documents as described in the Schedule 8 Annex 2 (T2S Deliverables list and management process).

T2S Framework Agreement

Schedule 9 – Change and Release Management

3 Entities involved in the CRM process

There are two levels differentiated in the CRM process: a “technical” level and a “Steering” Level. The Signatory CSDs and the Central Banks are expected to organise themselves according to these two levels.

3.1 Technical level

3.1.1 ECB

The ECB team supports the T2S Steering Level in the CRM process. The roles and responsibilities of the ECB at the different stages of the CRM process are described in the chapters 4.2 and 5.2 of this Schedule. They include, inter alia:

- being the entry point for all Change Requests;
- keeping a register of all Change Requests;
- managing their processing as described in this document;
- monitoring Change Requests during their entire lifecycle, from the initiation until they have reached their end status (i.e. implementation, withdrawal or rejection);
- monitoring the release definition and its implementation;
- tracking progress and issues that may influence decision-making and report them to the relevant groups; and
- ensuring availability of the relevant information to the relevant T2S Stakeholders.

3.1.2 4CB

In the context of the CRM process, the 4CB is entrusted with different roles and responsibilities as described in the chapters 4.2 and 5.2 of this Schedule. They include, inter alia:

- assessing the impact stemming from requests for new functionalities or technical enhancements from a regulatory, technical, functional and operational point of view (feasibility, planning, budget);
- building, configuration and delivery of a release into production;
- assessing the feasibility for implementing a change request in a release scope; and
- examining the impact on the system security and providing a security impact assessment.

T2S Framework Agreement

Schedule 9 – Change and Release Management

3.1.3 Signatory CSDs and the Central Banks

The euro area NCBs, the Signatory CSDs and the non-euro area NCBs in T2S are entitled to participate in the CRM process. Their roles and responsibilities at different stages of the CRM process are described in the chapters 4.2 and 5.2 of this Schedule. They include inter alia:

- acting as full members of the CRG
- initiating Change Requests on their own or customers' behalf;
- evaluating and monitoring Change Requests;
- monitoring release definition and implementation;
- testing and verifying releases; and
- involving their respective user communities in the process.

3.1.4 Change Review Group (CRG)

With regard to the CRM the CRG shall be responsible, for:

- reviewing Change Requests on a regular basis, evaluating the information provided in the Change Request and in the assessment (checking its consistency and completeness across all Change Requests)
- making recommendations to the T2S Steering Level on the authorisation of Change Requests;
- building and maintaining the ranking mechanism according for authorised changes in view of their selection by the PMG for detailed assessment;
- reviewing the content of each release, as well as any changes to the agreed release.

When making a proposal to the Steering Level for their decision-making, the CRG works in consensus, which means a process whereby the CRG synthesises its proposals and concerns to form a common collaborative agreement acceptable to all members. In case consensus cannot be found, the Chairperson reports differing views to the T2S Steering Level.

The CRG shall be informed and – to the extent possible and relevant – consulted on technical changes and changes that need to be implemented urgently in order to restore and continue the provision of T2S Services in accordance with the procedures defined in the Manual of Operational Procedures.

3.1.5 Project Managers Group (PMG)

With regard to CRM, inter alia, the PMG shall be responsible for:

T2S Framework Agreement

Schedule 9 – Change and Release Management

- preparing the plan for implementation of T2S releases;
- coordinating and monitoring the implementation of T2S releases;
- providing to the T2S Steering Level recommendation as regards the deployment of releases;
- providing a T2S release scope for approval to the T2S Steering Level based on the list of ranked and assessed Change Requests from the CRG and the list of prioritised production problems from the OMG;
- reviewing and monitoring the content of each release as well as any changes to the agreed T2S release scope.

3.1.6 Operations Managers Group (OMG)

With regard to CRM, inter alia, the OMG shall be responsible for:

- prioritising production problems that are pending resolution;
- providing to the T2S Steering Level recommendation as regards the deployment of releases; and
- assessing the proposed baseline release scope to verify whether the proposal adequately addresses the operational requirements.

3.2 Steering Level

Without prejudice to the role of (and delegation from) the Governing Council, the Governance bodies at the T2S Steering Level are (i) the Market Infrastructure Board (MIB), (ii) the T2S CSD Steering Group (T2S CSG) and (iii) the T2S Non-euro Currencies Steering Group (T2S NECSG) as defined in the T2S FA and the T2S CPA.

Each Governance body at the T2S Steering Level shall receive information from the Technical Groups via the ECB with respect to the CRM process. In the spirit of transparency, this information shall also be shared with the AMI-SeCo in accordance with Schedule 8 (Governance).

4 Decision-making process on Change Requests

1. Any Signatory CSD, User member in the AMI-SeCo, euro area NCB, non-euro area NCBs in T2S, the ECB or the 4CB may initiate a Change Request. Changes to Common

T2S Framework Agreement

Schedule 9 – Change and Release Management

Components may also be initiated within a TARGET Service⁴ other than T2S, by means of introducing a Change Request in accordance with the Governance processes of the respective TARGET Service.

2. The Change Request is reviewed by the Change Review Group (CRG) according to the procedures described in this Schedule. The CRG submits the Change Requests to the T2S CSG via the ECB. The ECB also provides the CRG deliverables to the MIB, the T2S NECSG and the Advisory Group on Market Infrastructures for Securities and Collateral (AMI-Seco) and publishes the deliverables on the ECB website. Should any of the before-mentioned Governance bodies as described in Schedule 8 fail to provide its view within a reasonable amount of time, taking into account the urgency of the Change Request, this Governance body is then assumed to have agreed with the Change Request and the decision-making procedure continues.
3. If the Change Request was related to safeguarding the integrity of the respective currency and/or financial stability as part of crisis management measures, transparency could be limited to the T2S Actors upon request of a Central Bank. Such Change Requests shall be made transparent at the latest when the change is taken up in a release.
4. The AMI-Seco gives its advice on the Change Request within a reasonable amount of time, taking into account the urgency of the Change Request. The advice of the AMI-Seco is addressed to the T2S Steering Level and it shall be published on the ECB website.
5. The T2S CSG takes a resolution on the Change Request within a reasonable amount of time, taking into account the urgency of the Change Request. The resolution of the T2S CSG is addressed to the MIB and it shall be published on the ECB website.
6. The T2S NECSG takes a resolution within a reasonable amount of time, taking into account the urgency of the Change Request. The resolution of the T2S NECSG is addressed to the MIB and it shall be published on the ECB website.
7. A final decision on the Change Request is taken by the MIB on behalf of the Governing Council within a reasonable amount of time, taking into account the urgency of the Change Request. The MIB decision is taken in consensus with the T2S CSG and the T2S NECSG taking into account the advice of the AMI-Seco.
8. If consensus cannot be achieved based on the above stakeholders' initial resolutions, the MIB aims at reconciling the different views in taking a final decision on the matter at hand:
 - a. The MIB coordinates discussions with relevant stakeholder groups in order to find a consensual solution to present to the T2S CSG, the T2S NECSG and the AMI-Seco.

⁴ The list of TARGET Services and Common Components is available in the T2S Operational Governance Processes Framework, which is listed in the Annex 2 to Schedule 8 as a T2S deliverable.

T2S Framework Agreement

Schedule 9 – Change and Release Management

For issues of key concern, establishing a compromised proposal may be an iterative process. Once consensus is reached within a reasonable amount of time, taking into account the urgency of the Change Request, the AMI-SeCo formally gives its new advice and the T2S CSG and the T2S NECSG take new resolutions on the Change Request.

- b. If such discussions do not lead to consensus, the MIB, the T2S CSG or the T2S NECSG may ask for a non-binding external advice except for matters related to safeguarding the integrity of currencies in T2S or to financial stability. The Third Party providing such advice needs to be selected by common agreement of the MIB, the T2S CSG and the NECSG and deliver its advice in parallel to the MIB, the T2S CSG, the T2S NECSG and the AMI-SeCo. All relevant stakeholder groups review their position on the basis of the non-binding external advice and the MIB coordinates discussions with the relevant stakeholder groups in order to find a consensual solution in accordance with paragraph 8a. Within a reasonable amount of time and taking into account the urgency of the Change Request, the AMI-SeCo formally gives its final advice and the T2S CSG and the T2S NECSG take final resolutions on the Change Request before the MIB takes the final decision on behalf of the Governing Council, or refers the latter at hand to the Governing Council.
9. The advice of the AMI-SeCo and the resolutions of the T2S CSG, T2S NECSG and MIB on T2S Change Requests are published on the ECB website.
10. The Signatory CSDs have the right to challenge the final decision of the Governing Council before the Court of Justice of the European Union.

5 Change Request management

5.1 Categorisation of Change Requests

The categories for Change Requests are reflecting the purpose and aim that a Change Request tries to achieve. The following categories are included: i) Regulatory compliance which is elaborated in the next section; ii) Standards compliance: A Change request resulting from a T2S harmonisation standards or other published standards that are relevant to T2S operations; iii) Scope enhancement: for Change Requests that introduce a new feature on functionality in T2S and is not raised due to a regulatory or a standards change; and iv) Maintenance: for Change Requests that do not fit in one the previous categories.

5.1.1 Changes driven by Legal and Regulatory Requirements

Changes motivated by Legal and Regulatory Requirements shall be dealt with according to the standard procedure set out in this Schedule with high priority, in accordance with Principle [4] of the General Principles of T2S, and following the relevant decision-making process. Such Change Requests have to be initiated by the affected entities.

However, several cases have to be distinguished:

- (a) Changes in European legislation are dealt with as quickly as possible or as required in the legislation. The analysis of the Change Request by the various Governance bodies mentioned in this Schedule concerns only the modalities of the implementation.
- (b) It is expected that the Signatory CSDs and Central Banks inform the MIB on any proposed change in national legislation with an impact on T2S as early as reasonably practicable. The relevant Change Requests shall be dealt with according to the standard procedure. The final decision shall be taken by the Governing Council and a potential refusal shall include the reasons why the implementation of the Change Request is not feasible.
- (c) Change Requests resulting from a Relevant Competent Authority request shall follow the standard procedure and the Eurosystem shall involve the AMI-SeCo, the T2S CSG and the T2S NECSG. Should these discussions lead to a disagreement with the Relevant Competent Authority, the Change Request shall be brought to the Governing Council and the Relevant Competent Authority shall be invited to submit its written view directly to the Governing Council. The Governing Council would then take due account of the views of the Relevant Competent Authority before making a decision. Should the Governing Council reject the Change Request, it shall provide a written explanation of the rationale to the Relevant Competent Authority. The Governing Council can reconsider its decision based on additional information provided by the Relevant Competent Authority. When a Change Request resulting from a Relevant Competent Authority request relates to only one market,

T2S Framework Agreement

Schedule 9 – Change and Release Management

it shall not be in contradiction with the General Principles of T2S and relevant costs shall be borne by the CSDs, i.e. the Signatory CSDs, subject to the regulatory decision.

- (d) Changes under (b) and (c) above which involve legislation or regulatory requirements in a non-euro area country are discussed in the Governors' Forum, if the Governor of the relevant non-euro area NCBs in T2S so requests.

The Eurosystem shall aim at finding solutions to the cases outlined above, including the possibility of optional features to the extent that they are technically viable and within the Lean Scope of T2S.

5.1.2 Type of change according to urgency

According to its level of urgency, a change falls under one of the following categories:

- **Normal changes:** changes that can be planned without time constraints and shall go through the CRM process before being implemented into the production environment.
- **Fast-track Changes:** changes that are imposed by Legal and Regulatory Requirements, or by T2S CSG resolutions related to risk management, or changes that are critical for the stability of the T2S Platform or imposed by Central Bank decisions related to safeguarding the currency/-ies or related to crisis management measures to ensure financial stability and that, owing to the time constraints, have to be implemented in a shorter timeframe than normal, which shall be decided on an ad-hoc basis. These changes shall also go through the CRM process, however, the length of the different process steps shall be shortened on an ad-hoc basis, in particular for preliminary and detailed assessment. The CRG may also provide a recommendation to the PMG to coordinate the allocation to a release and the detailed assessment without requiring a preliminary assessment in case of a fast-track change.

5.1.3 Type of change according to beneficiary

Irrespective of the urgency, all changes subject to the CRM process fall into one of the following categories:

- **Common Changes:** any new feature, functionality or service – or any amendment of an existing feature, functionality or service – which is implemented for the benefit of more than one T2S Actor.
- **Specific Changes:** In case of Specific Change i) the unauthorised use should be either controlled or monitored (as agreed in the request). ii) in order to avoid any impact on non-supporting Signatory CSDs/CBs, the implementation mechanism shall be based – if

T2S Framework Agreement

Schedule 9 – Change and Release Management

possible – on the approach that the functionality shall be made available to all T2S Actors, but that those not wishing to use it, are not impacted by the change. iii) If this backward compatibility cannot be ensured, the change can only be authorised upon agreement of each non-supporting CSD/CB. These changes may be triggered by:

- market-specific regulatory, legal, fiscal or market-specific requirements or,
- innovation or improvement considered useful by one or more Signatory CSDs or CBs.

5.1.4 Parameters of changes

Each change is categorised based on a number of parameters which are used to indicate how important or delicate a change is relative to other changes.

As the CRG is responsible for setting the value of these parameters for each Change Request deviations from the definitions are possible, as long as they are consensually agreed by CRG members.

5.1.4.1 Parameter 1: Legal/business importance

The importance of a Change Request derives from the business need for a change and should be part of the business justification. From an importance viewpoint, the Change Requests shall be classified into one of four categories as defined below:

Category	Definition
Critical	<ol style="list-style-type: none">1) A change required by the Eurosystem or by a non-euro area NCB in T2S to implement its statutory tasks.2) A change relating to an area which would - if the change is not implemented - prevent T2S Actors from connecting to and/or using T2S or put the requester in non-compliance (after implementing any work-arounds) with legal, regulatory (including, among others, unacceptable operational risks), or fiscal requirements.3) Changes to preserve security, systems availability and stability etc.
High	<ol style="list-style-type: none">1) A change that would offer a significant enhancement and benefits to the T2S Service or the T2S Actors.2) A change to embody agreed harmonisation in T2S where there is a high efficiency benefit.

T2S Framework Agreement

Schedule 9 – Change and Release Management

	<ul style="list-style-type: none"> 3) A change to significantly improve safety or stability. 4) A change to remove major ambiguity or inconsistency in the T2S Scope Defining Set of Documents or the T2S Documentation.
Medium	<ul style="list-style-type: none"> 1) A change with moderate efficiency benefits, but which does not have an important harmonisation dimension. 2) A change to improve the usability of the system. 3) A change to remove minor ambiguity or inconsistency in the technical and functional documentation.
Low	<ul style="list-style-type: none"> 1) Changes that are “nice to have” and are useful to pad out a release. 2) A change to improve clarity of the technical and functional documentation.

5.1.4.2 Parameter 2: Market implementation efforts

Change Requests shall be classified into three categories on the basis of the effort required by the market to properly implement and timely absorb the change (i.e. implement the necessary IT changes, adapt the operational procedures, integrate the change into the service offerings, adapt the legal arrangements, etc.). This parameter does not apply to purely editorial Change Requests.

Category	Definition
High	Changes that require high efforts (a long implementation time and significant resources) on the side of the majority of Signatory CSDs, CBs and/or their communities in order for them to be able to implement the change and take full benefit of it.
Medium	Changes that require high efforts (a long implementation time or significant resources) on the side of a minority of Signatory CSDs, CBs and/or their communities or medium efforts on the side of the majority of Signatory CSDs, CBs and/or their communities in order for them to be able to implement the change and take full benefit of it.
Low	Changes that do not require a long implementation time and any significant resources on the side of Signatory CSDs, CBs and their communities in order for them to be able to take full benefit of the change.

T2S Framework Agreement

Schedule 9 – Change and Release Management

5.1.4.3 Parameter 3: Operational/technical impact

Change Requests shall be classified into three categories on the basis of the operational/technical impact if the change is undertaken, i.e. the risk that a change might trigger (some) instability on the T2S Platform. The technical/operational risk of a change is its potential undesirable/unexpected adverse impact on the T2S Platform and on the Signatory CSDs/CBs. This parameter does not apply to purely editorial Change Requests.

Category	Definition
High	Changes that have the potential to significantly threaten the Service Level for a significant part of T2S Services or have a significant operational impact on the Signatory CSDs, CBs or 4CB, because insufficient mitigating measures can be taken.
Medium	Changes that have the potential to significantly threaten the Service Level for a minor part of T2S Services or have a limited operational impact on the Signatory CSDs, CBs or 4CB, because insufficient mitigating measures can be taken.
Low	Changes that are expected not to threaten the Service Level for Signatory CSDs or CBs or to have no or insignificant operational impact on the Signatory CSDs, CBs or 4CB.

5.1.4.4 Parameter 4: Financial impact for T2S

An indication of the impact of the change on the required cost shall be provided by the 4CB during the preliminary assessment phase. During the detailed assessment phase, the 4CB shall provide the precise investment cost and the annual running cost, including a breakdown on costs for hardware, software and telecommunication.

Change Requests shall be classified into five categories on the basis of the cost impact for the implementation of the Change Request.

Category	Financial Impact
Very high	Changes with an investment cost of at least 700,000 EUR

T2S Framework Agreement

Schedule 9 – Change and Release Management

High	Changes with an investment cost of at least 400,000 EUR, but less than 700,000 EUR
Medium	Changes with an investment cost of at least 200,000 EUR, but less than 400,000 EUR
Low-medium	Changes with an investment cost of at least 100,000 EUR, but less than 200,000 EUR
Low	Changes with an investment cost of less than 100,000 EUR

T2S Framework Agreement

Schedule 9 – Change and Release Management

5.2 Change Management process

All changes defined in chapter 2 as falling within the scope of the CRM process are subject to the Change Management (CM) process, the principles of which this section describes. The detailed description of Change Management is documented in the T2S Operational Governance Process Framework, which is listed in the Annex 2 to Schedule 8 (Governance) of the T2S FA and T2S CPA as a T2S deliverable.

5.2.1 Change Request Initiation and Registration

The requester, i.e. Signatory CSDs, euro area NCBs, non-euro area NCBs in T2S, the ECB or the 4CB, can submit a Change Request to the ECB using the standard form provided by the ECB team, mandatorily included the information listed in Annex 1 (Change Request Form) such as the title of the requested change, its description (changes in the existing features and functionalities, new features and functionalities in T2S), its business motivation (including the legal/regulatory requirement⁵), the urgency of the change, the categorisation of change, the date of the request, etc. Changes to Common Components may also be initiated within a TARGET Service⁶ other than T2S by means of introducing a Change Request in accordance with the Governance processes of the respective TARGET Service.

Users shall always initiate Change Requests indirectly via a Signatory CSD or a Central Bank. If this is not successful, Users can propose the initiation of a Change Request as a resolution in the AMI-SeCo. Then upon agreement of the AMI-SeCo, the Change Request is submitted for registration to the ECB who shall submit it to the CRG for consideration according to the process described in this chapter.

The requester should clearly state in the description of the change whether the change should be implemented as a Specific Change and whether the unauthorised use of the Specific Change should be prevented or monitored.

Upon receipt the ECB shall check the proposed Change Request for formal completeness, collect any missing information from the requester, register the Change Request and confirm its receipt to the requester. The ECB shall submit the registered Change Request to the CRG to perform a formal validation. The CRG shall check the clarity and completeness of the request, that no complementary changes shall be required for its implementation, confirm if the change should be assessed as a Specific Change and/or as a Common Change considering the interest expressed

⁵ Changes which are motivated by Legal and Regulatory Requirements shall be implemented according to chapter 5.1.1.

⁶ The list of TARGET Services is available in the T2S Operational Governance Process Framework, which is listed in the Annex to Schedule 8 of the T2S FA and T2S CPA as a T2S deliverable.

T2S Framework Agreement

Schedule 9 – Change and Release Management

by the other Signatory CSDs/ CBs and agree carrying on with the preliminary assessment. After the CRG's validation, the registered Change Request shall be published on the website⁷.

5.2.2 Preliminary assessment

Upon the agreement of the CRG to carry out the preliminary assessment, the ECB and the 4CB shall perform a preliminary assessment of the proposed Change Request.

The preliminary assessment includes:

- compliance check: whether it falls within the Lean Scope of T2S and does not conflict with another Change Request already submitted;
- functional assessment: how does it affect the functionality as described in the T2S Scope Defining Set of Documents;
- technical assessment: evaluate the technical feasibility and complexity, analyse which domains, business sub-areas or other real time gross settlement system and /or collateral management system systems shall be impacted. If necessary, the ECB shall cooperate with the relevant non-euro area NCBs and consult the relevant ESCB committees or business areas that are responsible for these Eurosystem services;
- cost assessment: preliminary indication of the impact of the change from a cost perspective (see Parameter 4 in chapter 5.1.4.4 above); and
- risk assessment: whether it could trigger instability to the T2S Platform or create performance problems.

The result of the preliminary assessment shall be provided by the ECB to the CRG for evaluation, in average 6 weeks and maximum 8 weeks from the agreement of the CRG to carry out the preliminary assessment.

While preliminary assessment is conducted by the ECB and 4CB, the Signatory CSDs and CBs shall consult their user communities in order to collect information on the change benefits and its impact on the process on the Users' side. This shall allow the Users to provide their input and ensure that T2S provides functionality according to the needs of the market.

The CRG shall review the outcome of the preliminary assessment and, based on that, provide a recommendation to the T2S Steering Level on whether to authorise or reject the Change Request for inclusion in the ranking procedure.

⁷ If the Change Request relates to safeguarding the integrity of the respective currency and/or financial stability as part of crisis management measures, transparency could be limited upon request of a Central Bank. This applies also if the Change Request relates to the security of T2S information or is, for any other reason, not to be published on the ECB website according to T2S Steering Level guidance.

T2S Framework Agreement

Schedule 9 – Change and Release Management

The CRG may also decide to reject a Change Request after preliminary assessment. This requires the agreement of the requester, in which case the process stops at this stage. The Governance bodies at the T2S Steering Level shall be informed accordingly. If there is a disagreement from the requester, the issue is escalated to the T2S Steering Level for guidance.

5.2.3 Authorisation

The T2S Steering Level authorises or rejects a Change Request in accordance with chapter 4 (Decision-making process on Change Requests). The T2S Steering Level may request further evaluation to be conducted by the CRG in order to complement the overall picture. In that case, the impacts of the Change Request shall be re-assessed/evaluated as described in chapter 5.2.2.

The final decision on the Change Request may be:

1. To reject the Change Request. If all Signatory CSDs and CBs agree on this decision then the process stops at this stage.
2. To authorise the change, as well as its cost recovery method, according to the principles specified in Schedule 7 (Pricing) to the T2S FA and the T2S CPA.

If a change is authorised after a failed dispute resolution in the Governors' Forum, which triggers the termination of the T2S CPA by a non-euro area NCB in T2S, the latter has the right to exit T2S within a maximum period of 24 months. During this time and to the extent relevant for the operation of T2S, the non-euro area NCB in T2S shall not be affected by the change that triggered their termination. If such a change is imposed by a competent EU authority, the concerned CB shall either make its best endeavours for a quicker exit, or shall make the necessary changes in its system so that T2S can implement the change.

The decisions of Governance bodies on Change Requests shall be published on the ECB website by the CRG Secretariat, unless otherwise agreed. Once authorised, the Change Request shall become part of the list of authorised changes, and hence become eligible for implementation in (one of) the next T2S release(s), as explained in chapter 6 on the Release Management process.

T2S Framework Agreement

Schedule 9 – Change and Release Management

6 Release management

The Release Management (RM) process ensures that all aspects of a change, technical and non-technical, are considered together. The main objective is to deliver, distribute and track one or more changes intended for simultaneous release into the live environment while protecting the integrity of the production environment and its services.

The RM process covers the planning, design, build, configuration and testing of software and hardware to create a set of release components for the production environment. The term “Release” is used to describe a collection of authorised changes which typically consist of enhancements to the T2S Service (i.e. new and/or changed software required and any new or changed hardware needed for the implementation of the changes) and a number of production problem resolutions which are implemented into the production environment.

The goal of the RM process is to ensure that authorised changes and the production problem resolutions that have been agreed as part of a release are secure and traceable, and that only correct, tested and authorised versions are installed into the production environment.

All authorised changes initiated via a Change Management process and the production problem resolutions process shall follow the RM process.

6.1 Release types and frequency

As of the T2S Go-Live Date the releases can be classified as follows:

- Major release: a release that consists of a set of software changes that affect a significant part of the functionality or that adds substantial new functionality. It may also include the resolution of identified production problems.
- Minor release: a release that encompasses a set of software changes to align with the regularly scheduled update of the ISO 20022 message standard, and, when feasible and agreed, to implement a limited number of Change Requests (including regulatory Change Requests) that do not affect a significant part of the functionality. It may also include the resolution of identified production problems.
- Fast-track release: if T2S is confronted with (i) changes that are imposed by Legal and Regulatory Requirements, or by T2S CSG resolutions related to risk management, or (ii) changes that are critical for the stability of the T2S Platform or imposed by Central Bank decisions related to safeguarding the currency/-ies or related to crisis management measures to ensure financial stability that cannot be bundled into the next major or minor release due to the time constraints, T2S shall comply, possibly with an additional release, typically containing only the relevant change(s).

T2S Framework Agreement

Schedule 9 – Change and Release Management

- Production problem release: it includes the resolution of identified production problems which cannot be planned for the next major or minor release.

The optimum frequency of releases should be balanced between the business requirements and the relative impact, risk and cost of the release. Consequently, depending on needs and resource allocation, and without prejudice to the need for any fast-track releases, the Eurosystem can support every year: one major release and - in case of need - one minor release and two production problem releases to resolve those identified production problems which cannot be planned for the next major or minor release.

The Signatory CSDs and CBs shall have the possibility to monitor the release implementation and to carry out the testing according to the provisions currently described in Schedule 3 (User Testing) to the T2S FA and to the T2S CPA⁸.

6.2 Release Management process

This chapter describes the principles of the Release Management process that applies to all authorised Change Requests and prioritised production problem. The detailed description of Release Management is documented in the T2S Operational Governance Process Framework, which is listed in the Annex to Schedule 8 of the T2S FA and T2S CPA as a T2S deliverable.

6.2.1 Ranking of Change Requests and prioritisation of production problems

Based on the lists of authorised changes⁹, the CRG shall examine each Change Request in detail and shall propose a ranking of these changes based on the business values allocated by CRG members and CRG observers to the authorised changes.

When conducting the ranking exercise, the CRG should consider the following criteria for Common Changes:

- to ensure a level playing field for all T2S Stakeholders in order to create the highest possible level of satisfaction throughout all T2S Actors/for each type of stakeholders' point of view;
- to consider those changes that bring benefits to the wide majority of the Signatory CSDs and CBs; and
- to select those changes which in total serve the interest of all Signatory CSDs and CBs.

The CRG should also consider the following criteria for Specific Changes:

⁹ Excluding those changes that are frozen during the exit time of a non-euro area NCB in T2S (see chapter 5.2.3)

T2S Framework Agreement

Schedule 9 – Change and Release Management

- to assess the changes with the aim of balancing the ratio of Common and Specific Changes;
- to select those Specific Changes requested by the Signatory CSDs/CBs that do not benefit to a large extent from the Common Changes; and

to increase the priority of Specific Changes in proportion to the time they are waiting to be implemented.

Similarly, the OMG shall prioritise all production problems that are pending resolution.

6.2.2 Definition of release

Based on the outcome of the Change Request ranking and production problems prioritisation exercises, the PMG shall prepare its proposal on the content of the next T2S release.

The ECB and 4CB shall prepare detailed assessments for those Change Requests and feasibility assessments for those Production problem resolutions included in the T2S release scope proposal of the PMG.

In the detailed assessment the impact of the Change Requests shall be evaluated based on the following dimensions:

Functional impact – to evaluate the functional consequences of a change, which function(s) it impacts.

Technical impact – to evaluate the technical consequences of a change, which module it impacts, the possible impacts on market participants and Common Components, the complexity of the change, etc.

Cost impact - the assessment of the costs in order to implement the feature. The financial impact shall cover the precise development costs, maintenance costs and the annual running costs as well as a breakdown of costs for hardware, software and telecommunication.

Legal impact - to evaluate the possible impact of the Change Request on the legal construction of T2S and to assess any legal, regulatory or fiscal requirements – particularly on the Signatory CSDs and CBs concerned, as well as Intellectual Property Rights-related issues.

Service Level impact – to evaluate the impact on the Service Level, including the KPIs agreed with the Signatory CSDs, CBs and the other T2S Users.

Documentation impact - assessment of the documents that shall need to be modified as a result of the Change Request. This can be the URD, GFS, UDFS, UHB, GS, GTD, Service Description, the GUI Business Functionality, User Handbooks, SLA, MOP etc.

Impact on the security of the system – to examine the impact on the system security and draw the attention to any risk that the Change Request would create.

T2S Framework Agreement

Schedule 9 – Change and Release Management

Impact on operations – to highlight any constraint that the Change Request may impose directly or indirectly on IT operations and the possible resulting technical, operational or financial impacts.

Compliance with the GDPR: to ensure the compliance of the T2S Service with the GDPR and the EUDPR.

The detailed assessment takes a maximum of 10 weeks for the ECB and 4CB after the decision to conduct the detailed assessment has been taken. Each Change Request shall be analysed without undue delay and its quality must be assured.

The Eurosystem shall provide justification when a Change Request cannot be implemented in a release due to lack of adapting its capacity. The Eurosystem shall make best efforts to adapt its capacity to manage the demand for Change Requests as soon as possible.

While defining and approving the scope of a T2S release the relevant bodies may reassess and amend the initial decision to authorise a Change Request.

Based on the outcome of the above process steps following the respective order, the PMG shall provide its recommendation for the T2S release scope to the T2S Steering Level after consultation with the OMG and CRG.

In case of disagreement in the PMG, the recommendation shall draw the attention of each group to the changes relevant for them, outline the reasons for disagreement and if possible suggest a few variants/options with respect to the release content.

6.2.3 Release baselining

In parallel to the release scope definition, the PMG shall prepare a detailed service transition plan that shall ensure synchronisation with the Signatory CSDs'/CBs' planning and presents the intended scope as well as all elements required to execute and monitor the release.

All Governance bodies at the T2S Steering Level (i.e. T2S CSG, T2S NECSG and MIB) shall review the PMG proposal on the content of the release including the related costs and the service transition plan for approval in accordance with chapter 4. At the end, the MIB shall take a decision on the recommended release scope and service transition plan, after obtaining the views from the T2S CSG and the T2S NECSG and if required, of the AMI-SeCo. The information on changes selected for the next T2S release shall be published on the ECB website.

The service transition plan for a specific release might be updated after its initial baselining following the same process.

6.2.4 Release monitoring

The PMG shall manage and monitor the service transition plan.

T2S Framework Agreement

Schedule 9 – Change and Release Management

The following key principles shall be followed in the context of release monitoring and reporting:

- A common service transition plan for the release shall be maintained based upon clearly identified deliverables and milestones taking into account all the respective constraints and dependencies of the involved T2S Actors;
- A regular and close monitoring of the service transition plan for the release, with decisions committing all T2S Actors shall be undergone based on a comprehensive framework established to manage events that may affect the release deliverables and milestones;
- Relevant documentation and necessary information shall be provided by the Eurosystem to all involved T2S Actors as background information for supporting release monitoring and reporting;
- Regular meetings shall be organised between the Eurosystem and the Signatory CSDs/ CBs to review and discuss the overall status assessment of the T2S release implementation, to discuss progress and any risks and issues that might jeopardize the release, and recommend mitigation measures/corrective actions;
- A reporting framework shall be established by the Eurosystem to inform regularly all involved T2S Actors at the various levels of Governance about the status assessment of the release implementation, including the progress against the plan, to provide status assessment of each deliverable relevant for Signatory CSDs and CBs and to ensure that the planning issues and risks are identified, discussed and addressed in a timely and appropriate manner;
- A T2S risk and issue management and reporting framework shall be established by the Eurosystem to identify, manage and report of risks and issues, affecting the successful delivery of the release;
- The Eurosystem shall monitor the readiness status of all involved T2S Actors to deliver the release into production; and
- The Signatory CSDs and CBs shall ensure their own readiness and coordinate the readiness of their clients to be ready to use the T2S release, i.e. ensuring planning feasibility and monitoring progress.

6.2.5 Implementation

The implementation phase starts with the designing, building and configuration through the final testing and verification stages and ends with the actual release into the production environment.

The implementation phase is initiated upon completion of the release baselining process, the principles of which are described in section 6.2.3. The release baselining process is completed at

T2S Framework Agreement

Schedule 9 – Change and Release Management

the latest one year before the planned go-live of a minor or major release. The lead time for a production problem resolution release may be less, when agreed. The baseline may be updated during the implementation phase, when agreed.

6.2.5.1 Design, building and configuration

Once the approved content of the release is communicated to the 4CB, the latter shall be responsible for designing, building and configuring the release. This process includes, inter alia, the following activities:

- Creating a new version of one or more software modules;
- Purchasing equipment or services externally;
- Preparing a hardware modification;
- Updating all relevant documentation or producing new one;
- Providing training to the Signatory CSDs and the CBs, if required¹⁰.

The following relevant documents are updated by the ECB and 4CB depending on the release scope, and shall be provided to the T2S Stakeholders at the points in time as specified in the agreed service transition plan:

- URD, GFS, UDFS, Service Description and GUI Business Functionalities, GS, GTD, User Handbooks, SLA, UHB

The ECB and 4CB shall ensure consistency across all documentation, including legal agreements and operational procedures.

6.2.5.2 Testing of a new release by the Signatory CSDs and the CBs

The Eurosystem shall provide assurances on the compliance of the delivered software with functional and non-functional requirements and might conduct a Eurosystem Acceptance Testing in case of releases impacting the T2S Service, as described in Schedule 5 (T2S Service Description) and in the T2S Scope Defining Set of Documents.

The Signatory CSDs and CBs start testing the new release once all the entry criteria for the User Testing are met. A stability period is envisaged in the pre-production where the system should be tested while running according to the Service Level Agreement. The length of this period shall be decided by the PMG on a case-by-case basis. The aim of the User Testing is to ensure that the new T2S release delivers the expected services as described in the User Requirements Document, as well as the functional and non-functional specifications and to guarantee the

¹⁰ The Signatory CSDs, respectively the CBs are responsible for the providing training to their users. On Signatory CSDs'/ CBs' request, the Eurosystem should agree on providing trainings for Signatory CSDs' resp. CBs' users for topics selected by Signatory CSDs/CBs.

T2S Framework Agreement

Schedule 9 – Change and Release Management

readiness of the Signatory CSDs and CBs and their communities for the migration/operation to/of the new release.

The User Testing activities are performed according to the framework agreed between the Signatory CSDs/ CBs, which may include a set of user certification tests to ensure that T2S Stakeholders are able to use the new or amended functionality correctly. As a matter of fact, the verification of the release is given by the Signatory CSDs and CBs once the exit criteria of the verification process have been completed successfully.

The security impact of all proposed changes to the T2S Platform should be assessed prior to delivery into production in order to check that they do not compromise the security of the T2S Platform. In this respect it is noteworthy that security should be planned and integrated from the start of development. This ensures that risk factors are adequately considered in a timely manner and prevents unnecessary costly security measures to be implemented only once the new system is operational.

The testing and release verification process by the Signatory CSDs and CBs shall typically take up to 3 months (i.e. for a major release).

The following principles shall be applied during User Testing phase of a release:

- The scope of release User Testing covers both functional and non-functional testing;
- The preparation of non-functional release User Test activities is done by the Eurosystem;
- The Signatory CSDs and CBs shall appoint a CSD respectively CB Test Manager who shall be the primary contact point for the Eurosystem for all discussions about user release testing;
- The Eurosystem shall appoint a T2S Test Manager who shall ensure proper coordination and exchange of information with the Signatory CSD's and CB's Test Manager;
- The execution of non-functional release User Test activities is the primary responsibility of the Eurosystem;
- The Eurosystem shall report to the Signatory CSDs/CBs about the results of non-functional release testing;
- User Testing of a new release aims at ensuring compliance of T2S with the T2S Scope Defining Set of Documents;
- The Signatory CSDs and CBs define their acceptance tests and agree these with the Eurosystem;
- The Eurosystem defines certification tests and agrees these with the Signatory CSDs and CBs;

T2S Framework Agreement

Schedule 9 – Change and Release Management

- User Testing of a new release is organised in different stages based on the concept and the principles laid down in Schedule 3 (User Testing);
- The Signatory CSDs and CBs are responsible for the co-ordination of User Test activities of a new release with their communities;
- The Eurosystem is responsible for the co-ordination of User Test activities of a new release between all T2S Actors; The Eurosystem shall support the User Testing activities of a new release through the implementation of Incident and problem management procedures as described in the Manual of Operational Procedures;
- The Signatory CSDs and CBs shall inform the Eurosystem of any Incident they experience during the execution of their User Tests of a new release;
- In particular, the Eurosystem shall undertake all necessary corrective measures to resolve all release defects discovered during the User Testing activities of a new release and caused by T2S;
- All decisions related to (un)successful completion of the test stages, as well as the implementation of the release in the production environment shall be prepared under the responsibility of the Project Managers Group (PMG) and shall be made in accordance with the Governance arrangements laid down in Schedule 8 (Governance).

6.2.5.3 Roll- out and communication

The service transition plan drawn up during the preceding phases shall be complemented with information about the exact installation process and the agreed implementation activities and delivery of the release into production.

The ECB in collaboration with the 4CB, Signatory CSDs and CBs shall agree in the OMG on the rollout planning which includes the following:

- Producing an exact, detailed timetable of events, as well as who shall do what i.e. resource plan;
- Producing the release note and communication to the Users;
- Planning communication;
- Non regression test report;
- Incident management.

All the impacted T2S Stakeholders shall be informed on what is planned and how it might affect them. The responsibilities of the interested T2S Actors in the implementation of the release shall be communicated by the ECB ensuring that everyone is aware of them. This shall be accomplished via the release communication/notes.

T2S Framework Agreement

Schedule 9 – Change and Release Management

6.2.5.4 Delivery – Go-live

Bringing the application software release into the production environment is the final step in the Release Management process.

To ensure a smooth roll-out of the release, the checklist and procedures agreed between the Eurosystem, 4CB, the Signatory CSDs and CBs need to be followed by all the involved T2S Actors.

The MIB shall give the formal and final acceptance of the release for the go-live based on the successful completion of the User Testing of the new release and after obtaining the views of the T2S CSG, and the T2S NECSG. The release is delivered into the production environment on the agreed date following the agreed procedures.

6.2.6 Post implementation review

A post implementation review shall take place periodically in order to evaluate the change/release performance and to verify the effectiveness of the change/release package implementation.

These review meetings shall provide an opportunity to assess and review the efficiency and effectiveness of the Change and Release Management Process, as well as to identify any potential improvement to the overall process flow.

7 T2S issue management

In addition to the risk management described in Schedule 10, T2S issues may materialize as part of the T2S evolution activities. T2S issue is an event affecting the ability to comply with the T2S evolution activities obligations and might originate from a materialised risk.

The T2S issue management, identification, registration and reporting process can be summarised as follows: all entities involved in the change and release management should flag to the ECB any T2S issues encountered. The ECB would then consolidate the T2S issues and share them with the relevant T2S Technical Groups. These groups would jointly agree on the follow up to the T2S issues.

When reporting a T2S issue the following information should always be provided: a high-level description of the issue, the background, the impact, the criticality and the proposed issue response plan.



EUROPEAN CENTRAL BANK

EUROSYSTEM

T2S FRAMEWORK AGREEMENT

SCHEDULE 9 – ANNEX 1 CHANGE REQUEST FORM

T2S Framework Agreement

Schedule 9 – Annex 1 - Change Request Form

T2S CHANGE REQUEST FORM		
General Information (Origin of Request) <input type="checkbox"/> User Requirements (URD) or GUI Business Functionality Document (BFD) <input checked="" type="checkbox"/> Other User Functional or Technical Documentation (SYS)		
Request title:		
Request raised by:	Date raised: DD/MM/YYYY	Request No.: T2S 0XXX SYS
Request type: Common / Specific	Classification: Regulatory compliance / Standards compliance / Scope enhancement / Maintenance ¹	Urgency: Normal / Fast track
1. Legal/business importance parameter²:		2. Market implementation efforts parameter³:
3. Operational/Technical risk parameter⁴:		4. Financial impact parameter⁵: (provided by 4CB)
Requestor Category: CSD / euro area NCB / non-euro area NCB in T2S / ECB / 4CB		Status:

Reason for change and expected benefits/business motivation:

Description of requested change:

Submitted annexes / related documents:

Outcome/Decisions:

Documentation to be updated:

Impact on personal data Y/N, (if yes please specify):

¹ **Regulatory compliance:** The CR results from a change in the legal or regulatory framework applicable to T2S actors or relevant to T2S itself. **Standards compliance:** The CR results from the T2S harmonisation standards or other published standards that are relevant to T2S operations. **Scope enhancement:** The CR introduces a new feature or functionality in T2S, and is not driven by regulation or standards. **Maintenance:** Any CR that doesn't fit in one of the previous categories

² Legal/business importance parameter was set to [...] because [...]

³ Market implementation effort parameter was set to [...] because [...]

⁴ Operational/technical risk parameter was set to [...] because [...]

⁵ Low < 100kEUR < Low-Medium < 200 kEUR < Medium < 400kEUR < High < 700kEUR < Very high

T2S Framework Agreement

Schedule 9 – Annex 1 - Change Request Form

Preliminary assessment:

Detailed assessment:



EUROPEAN CENTRAL BANK

EUROSYSTEM

T2S FRAMEWORK AGREEMENT

SCHEDULE 9 – ANNEX 2 CHANGE REQUEST STATUS

T2S Framework Agreement

Schedule 9 - Annex 2 – Change Request Status

At any time, a Change Request shall have one of the following statuses:

Registered – The Change Request was registered by the ECB.

Preliminary assessed – The 4CB have delivered the preliminary assessment of a Change Request

Authorised at Steering Level – The Steering Level has authorised the change and it was placed on the official list of changes.

On-hold – The change request has been ranked but it is put on a stand-by status until it is proposed for a release.

Proposed for a release – The PMG has requested the detailed assessment of the Change Request.

Allocated to a release – The Steering level has approved the implementation of the Change Request by a specific date/release.

Implemented – The Change Request has been implemented in T2S and all relevant documentation has been updated and all other impacted documents have been aligned.

Withdrawn – The Change Request initiator has withdrawn the Change Request.

Rejected – The Change Request has been rejected.



EUROPEAN CENTRAL BANK

EUROSYSTEM

T2S FRAMEWORK AGREEMENT

SCHEDULE 10

OPERATIONAL RISK, CYBER RESILIENCE AND INFORMATION SECURITY

T2S Framework Agreement

Schedule 10 – Operational Risk, Cyber Resilience and Information Security

Table of contents

1. OBJECTIVE AND SCOPE OF T2S OPERATIONAL RISK MANAGEMENT.....	4
1.1 T2S OPERATIONAL RISK MANAGEMENT OBJECTIVES.....	4
1.2 T2S OPERATIONAL RISK MANAGEMENT SCOPE AND APPLICABLE FRAMEWORKS	4
2. GENERAL RESPONSIBILITIES OF THE PARTIES	6
2.1 GENERAL RESPONSIBILITIES OF THE EUROSISTEM	6
2.2 GENERAL RESPONSIBILITIES OF THE SIGNATORY CSDS.....	7
3. THE THREE LINES MODEL.....	8
3.1 STEERING LEVEL	9
3.2 TARGET SERVICES THIRD LINE	10
3.3 TARGET SERVICES SECOND LINE	10
3.4 TARGET SERVICES FIRST LINE	10
3.5 INVOLVEMENT OF T2S TECHNICAL GROUPS.....	11
4. THE TARGET SERVICES CYBER RESILIENCE AND INFORMATION SECURITY FRAMEWORK.....	12
5. T2S OPERATIONAL RISK MANAGEMENT PROCESSES.....	14
5.1 CORE T2S OPERATIONAL RISK MANAGEMENT PROCESSES	14
5.2 SIGNATORY CSDS CONTRIBUTION.....	15
5.3 INFORMATION SHARING	16

T2S Framework Agreement

Schedule 10 – Operational Risk, Cyber Resilience and Information Security

Introduction

This document presents the provisions ensuring that risks related to the operation of T2S are adequately identified, assessed, managed and mitigated.

Risk management for the TARGET Services¹ is governed by the overarching Eurosystem/ESCB/SSM Operational Risk Management (ORM) Framework². A specific TARGET Services Risk Management Framework (TS RMF)³, covering also T2S, clarifies the governance aspects related to the management of TARGET Services risks, roles and responsibilities, the three lines model and the process for identifying, assessing and managing risks.

This document is divided into five chapters: (1) objective and scope of T2S Operational Risk Management; (2) general responsibilities of the Parties; (3) the Three-Lines Model, (4) the T2S Cyber resilience and information security framework, and (5) the T2S Operational Risk Management processes.

¹ The list of TARGET Services is available in the T2S Operational Governance Process Framework, which is listed in the Annex 8 to Schedule 2 as a T2S deliverable.

² The Eurosystem/ESCB/SSM ORM Framework comprises all Eurosystem/ESCB as well as SSM tasks and processes and related outcomes that manage operational risks which could jeopardise the achievement of the objectives of the Eurosystem/ESCB or the ECB within the SSM.

³ The TARGET services risk management framework describes the risk management concepts applicable to the TARGET services, covering all relevant risks, the implemented processes and the involved stakeholders.

T2S Framework Agreement

Schedule 10 – Operational Risk, Cyber Resilience and Information Security

1. Objective and scope of T2S Operational Risk Management

1.1 T2S Operational Risk Management objectives

T2S Operational Risk Management aims to provide the Market Infrastructure Board with the necessary tools and information to ensure that T2S will (continue to) deliver its services in the face of potential adverse events. It covers, for example, the identification, assessment, reporting and monitoring of risks that may have negative consequences on T2S.

1.2 T2S Operational Risk Management Scope and Applicable Frameworks

1.2.1 Connection to the TARGET Services Risk Management Framework

T2S Operational Risk Management is performed according to the TARGET Services Risk Management Framework (TS RMF). The TS RMF, which is consistent with the Eurosystem/ESCB/SSM Operational Risk Management (ORM) Framework explains how the operational risk management is implemented for the TARGET Services, including T2S. The TS RMF also contains references to the applicable TARGET Services Cyber Resilience and Information Security Framework (TS CRIS F) which defines more detailed processes for the specific CRIS aspects and is described in the section 4 of this Schedule.

Figure 1 depicts how the TS RMF is related to the ORM framework as well as the TS CRIS-F. The ORM framework is applicable to the ESCB and is considered an umbrella framework. The TS CRIS-F outlines the processes and the requirements for ensuring Cyber Resilience and Information Security (CRIS) of the TARGET Services. Specifically, the TS CRISF outlines

T2S Framework Agreement

Schedule 10 – Operational Risk, Cyber Resilience and Information Security

the threat management processes used for identifying, assessing CRIS-related threat scenarios, and indicating their plausibility and impact on TARGET Services.

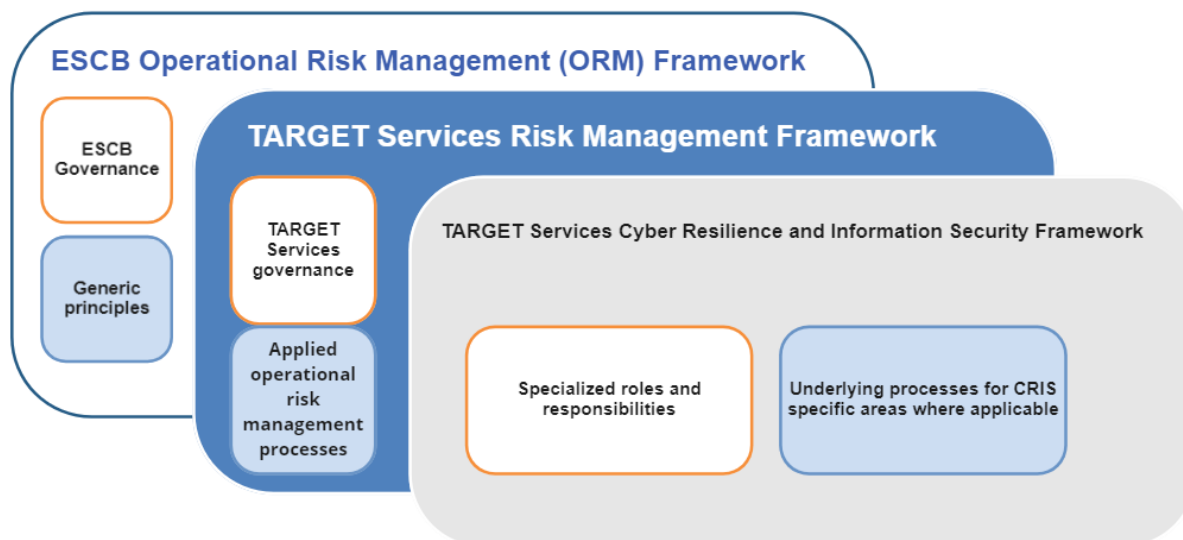

Figure 1: Encompassing frameworks

In the context of T2S and with respect to the Signatory CSDs, the document “T2S Operational Risk Management CSD Information and Contributions” provides an extract of the TS RMF documentation which is relevant for the Signatory CSDs and explains further their contributions to the T2S operational risk management.

1.2.2 Operational Risk scope and definition

Following the TS RMF a TARGET Service operational risk is defined as the risk of negative financial, business and/or reputational impacts on the Eurosystem resulting from inadequate or failed internal governance and business processes, people, systems and external events insofar that such a risk is under the MIB remit. An operational risk is assessed considering the impact and likelihood linked to the identified risks root causes (leading to a risk event). Thus, T2S operational risks include all risks that may affect the T2S operations, encompassing the risks projects and releases could pose to T2S.

Given the interdependencies between T2S and the Signatory CSDs, TARGET Services could also pose threats for the Signatory CSDs and their Users (e.g. malfunctioning, unavailability of services or data integrity issues) which may lead to risks. These risks are to be managed according to their own risk management frameworks. While the “T2S Operational Risk Management CSD Information and Contributions” document outlines the management of the

T2S Framework Agreement

Schedule 10 – Operational Risk, Cyber Resilience and Information Security

T2S operational risks including the risks posed by the Signatory CSDs to T2S, it also describes information sharing practices concerning the risks that are posed by the TARGET services to the CSDs.

In order to address the aforementioned risks and enhance the T2S operational risk posture, the Signatory CSDs and the Eurosystem shall share information about the risks that they might pose to each other. In that context, the risk information provided to the Signatory CSDs describes a potential negative impact on the T2S business functions that the Signatory CSDs are relying on. The Signatory CSDs can then use the provided information to manage their own risks stemming from their interdependencies with T2S. Reciprocally, the Signatory CSDs shall inform the Eurosystem about the threats they and/or their Users pose to T2S which serves as an input when assessing the T2S risks stemming from the Signatory CSDs and the Users.

The risks of the Signatory CSDs which are managed within the Signatory CSDs are not within the scope of the T2S Operational Risk Management. However, T2S provides functionalities (e.g. securities settlement functionalities, or auto-collateralization) that help the Signatory CSDs to manage such risks. Such functionalities are covered within the User Detailed Functional Specifications and Manual of Operational Procedures (MOP).

2. General responsibilities of the Parties

As an overarching principle, the Eurosystem and the Signatory CSDs shall co-operate in good faith in order to allow both Parties to fulfil their commitments with respect to the appropriate management of T2S Operational Risks.

2.1 General responsibilities of the Eurosystem

The Eurosystem shall:

- a) implement the TS RMF which adequately manages all operational risks, including Cyber Resilience and Information Security-related risks;
- b) implement the TS CRISF, in particular by designing, developing and operating the T2S Platform with the objective that the availability of the T2S Services and the confidentiality and integrity of the data is adequately protected;
- c) implement a review process to keep the TS CRIS F fit for purpose and up-to-date to

T2S Framework Agreement

Schedule 10 – Operational Risk, Cyber Resilience and Information Security

- appropriately manage operational risks and especially the CRIS-related risks in an evolving threat landscape;
- d) share with the Signatory CSDs the asset classification scheme and likelihood and business impact grading scales used in the risk management process for information;
 - e) report the results of risk assessments and security reviews (for example, related to new releases) to the Signatory CSDs;
 - f) report cyber resilience and information security incidents and the related treatment to the Signatory CSDs;
 - g) report to the Signatory CSDs information about newly identified risks and about threat scenarios that might threaten the confidentiality and/or integrity of TARGET Services data, and/or availability of the T2S Services, as well as any related treatment that is envisaged to address them;
 - h) provide all other relevant information to the Signatory CSDs to allow the latter to fulfil their own risk management obligations.

2.2 General responsibilities of the Signatory CSDs

In view of adequately managing the operational risks related to T2S, the Signatory CSDs shall:

- a) ensure their own compliance with Cyber Resilience and Information Security requirements according to its internal standards, regulatory requirements and/or best practices;
- b) follow the MIB guidance – in the context of managing Cyber Resilience and Information Security-related risks, in particular towards TARGET Services Ecosystem entities⁴. The Signatory CSDs shall also ensure that their respective Directly Connected Parties follow the relevant guidance;
- c) exchange information about cyber resilience and information security incidents with

⁴ Ecosystem entities are the different TS, TARGET Participants, TIPS reachable parties, T2S Directly Connected Actors (DiCoAs) and T2S Indirectly Connected Participants (ICPs). Furthermore, the ecosystem entities include messaging/network service providers and service bureaux.

T2S Framework Agreement

Schedule 10 – Operational Risk, Cyber Resilience and Information Security

- the Eurosystem, to the extent they are relevant for T2S or for other T2S Actors impacted by such incidents;
- d) report to the Eurosystem information about newly identified risks and/or threat scenarios that might threaten/affect the (data confidentiality and/or data availability and/or integrity of the) T2S Services to the extent the information is relevant for T2S and for T2S Actors; and,
- e) contribute to the operational risk management related to T2S as described in section 5 of this Schedule.

3. The Three Lines Model

In order to strengthen the risk management of all the TARGET Services, the Governing Council endorsed the implementation of the Three Lines Model (3LM). The 3LM represent different operational, managerial and auditory bodies with varying degrees of independence and specificity that aim to implement, organise and oversee the management of risks within the TARGET services. Within the 3LM, the TS RMF is developed, implemented and audited. The TS RMF supports the regular collection and consolidation of risk information and the creation of action plans for the benefit and endorsement of the MIB, via harmonised risk management processes that apply to all TARGET Services, including T2S, and risk types.

Figure 2 depicts the steering level as well as the setup of the 3LM for the TARGET Services below the MIB.

T2S Framework Agreement

Schedule 10 – Operational Risk, Cyber Resilience and Information Security

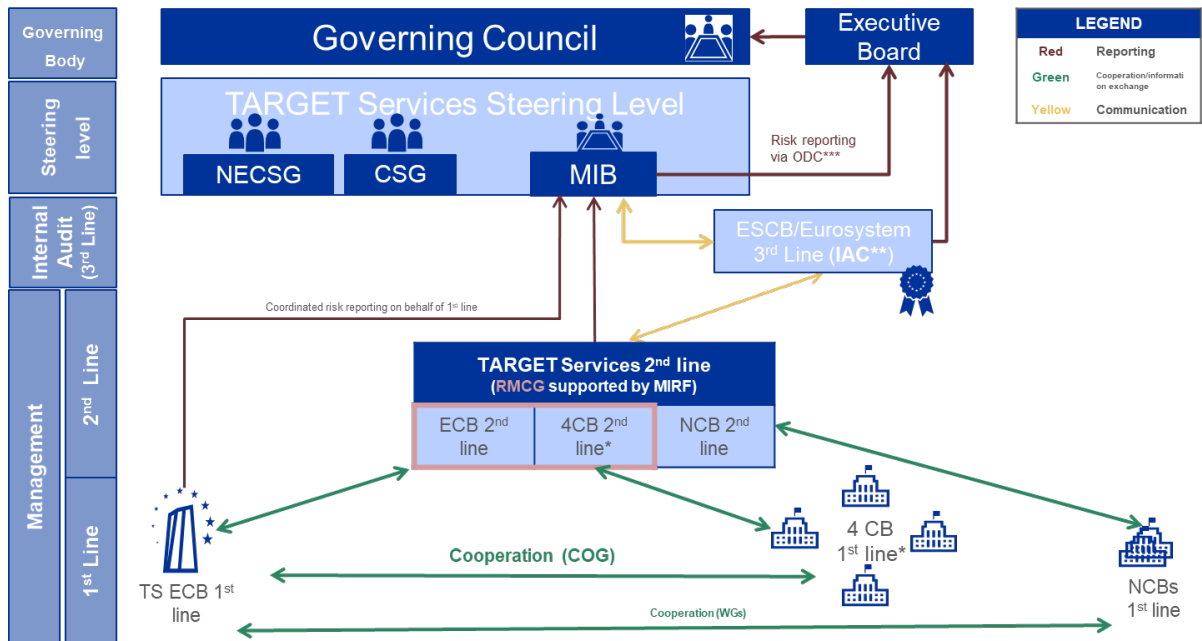

*This line does not represent the local reporting of the respective lines to the steering level

** The IAC is not an exclusive audit function for the TARGET Services

***This graph does not depict the Eurosystem Three Line Model. It is important to note, however, that the risk reporting from the MIB to the Executive Board/Governing Council is done via the Eurosystem second line (i.e. the ODC)

Abbreviations:

MIB – Market Infrastructure Board

CSG – CSD Steering Group

COG – Coordination Group

RMCG - Risk management coordination group

ODC –Eurosystem’s Organizational Development Committee (Eurosystem’s 2nd line)

NECSG – Non-euro Currencies Steering Group

4CB – The 4 service-providing central banks

IAC – Eurosystem’s Internal Audit Committee

MIRF – Market Infrastructures risk forum (all NCBs + ECB)

Figure 2: Organisation of the Three Lines Model for TARGET services

3.1 Steering Level

Market Infrastructure Board (MIB)

The MIB’s responsibilities include, among others, preparing proposals for decision of the Governing Council as regards the implementation and management of the relevant risk management frameworks for the TARGET Services, including T2S..

T2S Framework Agreement

Schedule 10 – Operational Risk, Cyber Resilience and Information Security

CSD Steering Group (CSG)

As described in the CSG mandate annexed to Schedule 8, the CSG discusses all matters of relevance for the Signatory CSDs, which also include risk topics.

Non-euro Currencies Steering Groups (NECSG)

The Governing Council and the decision-making bodies of the non-euro area NCBs in T2S have established the Non-euro Currencies Steering Group (NECSG). As described in its mandate annexed to Schedule 8, the NECSG discusses all matters of relevance for the non-euro area NCBs in T2S, which also include risk topics.

3.2 TARGET Services third line

The third line provides the Steering Level with independent assurance and consulting services on the governance, risk management, and internal controls, based on the highest level of independence and objectivity within the organisation. The Internal Auditors Committee (IAC) is the internal audit function for the Eurosystem/ESCB that acts as the third, independent line within the existing governance framework. Its purpose, authority and responsibility are defined in the [Audit Charter](#) for the Eurosystem/ESCB.

3.3 TARGET Services second line

The TARGET Services second line defines the operational risk management principles and frameworks, monitors their implementation and provides a holistic risk view. It is composed of operational risk managers and relevant experts having a deep understanding of risk management methods and standards, as well as the expertise to conduct risk assessments holistically. The TARGET Services second line is independent from operations and has a direct reporting line to the Steering Level. The objective of the TARGET Services second line is to ensure that the first line activities are properly designed and implemented, that the controls in place effectively mitigate risks and that the operational risks are managed appropriately in a forward-looking manner. Thus, the TARGET Services second line shall help identify changes to the threat landscape and availability of new tools and mechanisms to better safeguard the security of the TARGET Services.

3.4 TARGET Services first line

The TARGET Services first line is constituted by operational management whose main role is to ensure efficient and smooth operations of the TARGET Services. The TARGET Services

T2S Framework Agreement

Schedule 10 – Operational Risk, Cyber Resilience and Information Security

first line, therefore, is composed of experts with a deep understanding of the operations of the respective TARGET Services. As a principle, risks are managed within the TARGET Services first line, with each identified risk being assigned to a risk owner.

The TARGET Services first line is supported by a central risk coordination function including the central risk coordinator(s), also part of the TARGET Services first line, which facilitates the timely reporting of emerging risks and risk changes, maintains an inventory of all TARGET Services risks (risk register), and updates the risk register on the basis of the evolving risk landscape.

3.5 Involvement of T2S Technical Groups

The T2S Technical Groups are consulted in the risk management process and contribute to risk management in the various steps of the process. The Table 1 below illustrates how the T2S Technical Groups in which the Signatory CSDs are represented contribute to the management of operational risks. These groups are not part of the lines composing the TARGET Services Three Lines model. The contributions of the Signatory CSDs are further detailed in section 5.2

It should be noted that the TARGET Services first line can on top of other operational risks also identify general business and legal risks which are managed by the MIB.

Table 1: Involvement of T2S Technical Groups

		OMG	PMG	SMG
T2S risks	T2S operational Risks (excluding categories below)	C	I	I
	cyber resilience and Cyber resilience and information security	C	I	C
	Operational risks from evolution activities	C ⁵	C	I
Responsible	Does the work. Others can be asked to assist in a supporting role.			

⁵ The OMG will also consider operational risk stemming from evolution activities meaning those risks, which can have an impact on operations after the implementation of the release. Such risks shall be communicated from the PMG to the OMG.

T2S Framework Agreement

Schedule 10 – Operational Risk, Cyber Resilience and Information Security

Accountable	Ultimately answerable for the correct and thorough completion of the work.
Supports	As part of a team, they work with the person responsible. Unlike the consulted role, the support role helps complete the task.
Consulted	Those whose opinions are requested and with whom there is two-way communication.
Informed	Those who are informed (kept up-to-date).

4. The TARGET Services Cyber Resilience and Information Security Framework

This chapter describes the documents that underpin the Eurosystem’s commitments in the management of operational risks with a particular focus on managing cyber resilience and information security-related risks. The Eurosystem defines and maintains a TARGET Services Cyber Resilience and Information Security Framework (TS-CRISF) to ensure that the availability of the T2S Service and the confidentiality and integrity of its data are adequately protected.

The TS-CRISF is elaborated on the basis of the ISO Standards 27001 and 27002, as updated over time, both for the management system that shall ensure the adequateness of the framework and the framework’s Security Requirements and Controls (SRC) that shall be implemented for the T2S Services.

The TS-CRISF includes a Cyber resilience and information security (CRIS) Policy whose main objectives are: (i) preservation of the confidentiality, integrity, availability, authenticity, accountability, non-repudiation and reliability of TARGET Services information and (ii) maintaining and promoting the TARGET Services’ ability to anticipate, identify, withstand, contain and recover from cyber-attacks. The CRIS Policy also elaborates on the relationship between local CRIS Risk Assessments performed at the level of the 4CB and the CBs for assessing and managing risks related to the TARGET Services and the Operational Risk Management processes as defined by the TS RMF.

In addition, the TS-CRISF elaborates a Threat Management Manual (TMM) which describes a process for assessing threat scenarios (i.e. a combination of threat actor, vulnerability(ies) and threat events) that may occur on the TARGET Services. The output of the TMM processes (i.e. the defined Threat Scenarios and the assessment of plausibility and impact on the TARGET Services) is provided as input to the Operational Risk Management processes whereby the assessed threat scenarios may appear (depending on relevance and severity) as risk root causes to one or more operational risks.

T2S Framework Agreement

Schedule 10 – Operational Risk, Cyber Resilience and Information Security

The SRC of the TS-CRISF are based on ISO 27002⁶. The SRC are complemented with: (i) specific exceptions to the ISO 27001/2 Standard for the T2S Services where these are deemed necessary from a risk and/or cost/benefit perspective, and (ii) additional requirements inspired on the Eurosystem’s Cyber Resilience Oversight Expectations (CROE)⁷, in particular to cover also cyber resilience aspects. The SRC is aligned to the furthest extent with the CROE’s “Advancing” level of expectations. The TS-CRISF outlines a strategy to take active steps over time to align with the CROE’s “innovating” level of expectations.

The controls defined in the SRC are applicable to the Eurosystem stakeholders⁸ as specified in the TS-CRISF Policy. The defined implementation guidance (based on ISO 27002 and complemented with additional guidance to align with CROE) shall in principle also be applicable, with the exception that the implementation guidance may be deviated from in case this is suggested on the basis of specific risk assessments regarding the implementation of specific controls and the risks these intend to mitigate. Such deviations will be reviewed by the TARGET Services Second Line and challenged where appropriate.

The TS-CRISF also elaborates on activities to be organised with the TARGET Services ecosystem regarding the assessment of risks and relevant threats scenario information and the collection of information from relevant Ecosystem entities. The collected information will help assist the risk managers to appropriately assess the risks that may stem from Ecosystem entities (depending on their security posture).

⁶ The first version of the TS-CRISF is based on ISO 27002:2013. The TS-CRISF shall be reviewed annually and shall evolve according to the threat landscape and the release of updates to relevant standards, in particular the ISO 27002 standard.

⁷

https://www.ecb.europa.eu/paym/pdf/cons/cyberresilience/Cyber_resilience_oversight_expectations_for_financial_market_infrastructures.pdf

⁸ The 4CBs and the CBs participating in TARGET Services for their infrastructure supporting their own TARGET service desk operations and their own participation in TARGET Services.

5. T2S Operational Risk Management processes

5.1 Core T2S Operational Risk Management processes

The T2S Operational Risk Management processes include the risk identification, risk assessment/responses, risk approval/reporting and risk monitoring. Table 2 describes each of these processes. They involve the T2S Stakeholders as described in section 3.5.

Table 2: Core risk management processes

Core Process	Description
Risk identification	Generate a comprehensive list of risks that have a negative business, financial or reputational impact (BFR) for the Eurosystem (as TARGET Services and thus T2S Operator) or prevent the achievement of the business objectives i.e. functioning TARGET Services.
Risk assessment/responses	Assess the nature of the risk(s), determine its / their magnitude and select the most appropriate risk response option balancing the costs and efforts of implementation against the benefits derived.
Risk approval/reporting	Reporting of newly identified risks as well as risks updates for review by the steering Level, respectively Governing Council and subsequent endorsement respectively approval or rejection of the risk.
Risk monitoring	Supervise the risk status and progress stage by implementing mitigation measures and, reporting changes to the risk situation, Incidents, trends and environment.

The risk management processes (risk identification, assessment/responses, approval/reporting and monitoring) are interfaced with the change and release management and with Incident management processes to ensure that all operational risks have been identified and assessed and that appropriate risk mitigation measures are in place for identified risks.

As part of the risk monitoring, operational risks are reviewed considering various triggers (such as Incidents, updated threat scenarios for example) at least every quarter. The risk reporting is shared with the T2S Technical Groups before being submitted to the MIB for endorsement.

Figure 3 depicts how each of the risk management processes interact with one another, specifically, considering the perspective of risk life cycle, from its registration to update. (1) Risk registration and (2) Risk update represent the two core risk workflows that cover the

T2S Framework Agreement

Schedule 10 – Operational Risk, Cyber Resilience and Information Security

risk management from its initial triggering to the risk approval and reporting.

In the context of T2S and with respect to Signatories being CSDs, the T2S Operational Risk Management CSD Information and Contributions document depicts risk registration and risk update workflows within which the contributions of different stakeholders are outlined. New risks follow the risk registration workflow until they are approved. Thereafter they follow the risk update workflow.

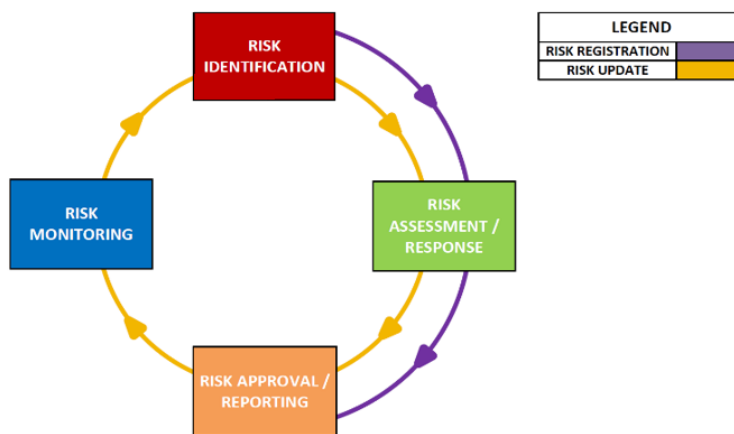

Figure 3: core risk management processes

5.2 Signatory CSDs contribution

The Signatory CSDs shall actively contribute to the risk discussions for T2S and share their perspectives during the T2S Technical Group meetings as members of the respective groups. Signatory CSDs shall contribute to each of the core process envisaged in the TS RMF, by reviewing and commenting on the filled in risk templates in Technical Groups meetings and consultations.

In the risk identification process, Signatory CSDs help identify potential risks that they might introduce to T2S and vice versa. As for the risk assessment/response process, Signatory CSDs engage in discussions within Technical Groups to evaluate the likelihood and the potential impact of the identified risks. Furthermore, Signatory CSDs are encouraged to discuss appropriate responses for the T2S operational risks. In the risk approval/reporting process, Signatory CSDs' contribution is limited to providing their comments on the shared risk information. Signatory CSDs may also stress and underline the risks which they believe require the consideration and attention of the Steering Level. Lastly, given the dynamic nature

T2S Framework Agreement

Schedule 10 – Operational Risk, Cyber Resilience and Information Security

of risks, in the risk monitoring process the Signatory CSDs shall contribute to continuously review and check the status of operational risks (section 3.5) and the corresponding risk responses. Thus, they help detect emerging operational risks, refine control objectives, and ensure that risks are proactively monitored and reported.

5.3 Information sharing

Signatory CSDs shall contribute to core risk management processes for T2S. As such, Signatory CSDs shall provide information on risks/threats that T2S Stakeholders and Actors may pose to T2S and receive relevant information about the risks/threats that T2S may pose to them. The risk information should be kept at sufficiently high level and shall not represent confidential information.

Information sharing with the Signatory CSDs shall take place in a two-way information exchange scheme. This scheme consists of (1) outbound information provided by the Eurosystem to the Signatory CSDs and (2) inbound information provided by the Signatory CSDs to the Eurosystem.

Additional provisions for the sharing of CRIS-related aspects are included in the TS CRIS F.

5.3.1 Outbound Information

Outbound information is shared by the Eurosystem with the Signatory CSDs with due consideration of its relevance and usefulness for the Signatory CSDs. Such information involves information on individual risks. Outbound information contains risk description, risk root causes and impact assessment focusing on risks' impact on the smooth operation of T2S. The business impact assessment provides a detailed assessment according to indicators within the pre-determined T2S business impact grading scale (which in the context of T2S and with respect to Signatories being CSDs, are included in the T2S operational risk management CSD information and contributions document). Table 3 demonstrates the outbound information for a given risk.

Table 3 T2S Risk information

Description and assessment of main risk root causes (RC)	Risk likelihood	Impact assessment (Business Impact only)
---	------------------------	---

T2S Framework Agreement

Schedule 10 – Operational Risk, Cyber Resilience and Information Security

<ul style="list-style-type: none"> • RC1: sub-optimum operational procedures... • RC2: potential Incident re-occurrence • RC3: relevant threats (incl. ecosystem-based threats) • ... 	<p>Assessment of overall likelihood of impact resulting from each root cause</p>	<p>Assessment based on root causes' overall impact according to the business impact grading scales</p>
---	--	--

In addition to information on individual risks that is shared with the Signatory CSDs, a holistic T2S risk view is shared with the (NE)CSG and presents a high-level description of operational risks.

5.3.2 Inbound Information

Inbound information is shared by the Signatory CSDs to the Eurosystem to support the T2S risk management along pre-defined criteria. This information would complement the available risk information and the assessment of the potential impact of risks on the smooth operation of T2S. To this end, inbound information could involve information on (1) risk elements/factors stemming from the ecosystem entities, (2) risk elements/factors stemming from the Signatory CSDs, (3) risk likelihood, and (4) impact assessment considering Signatory CSDs' perspective. That way Signatory CSDs contribute to the assessment of risk root causes,

T2S Framework Agreement

Schedule 10 – Operational Risk, Cyber Resilience and Information Security

assessment of risk likelihood and assessment of business impact. Figure 4 depicts how inbound information provided by the Signatory CSDs may contribute to T2S risk assessment.

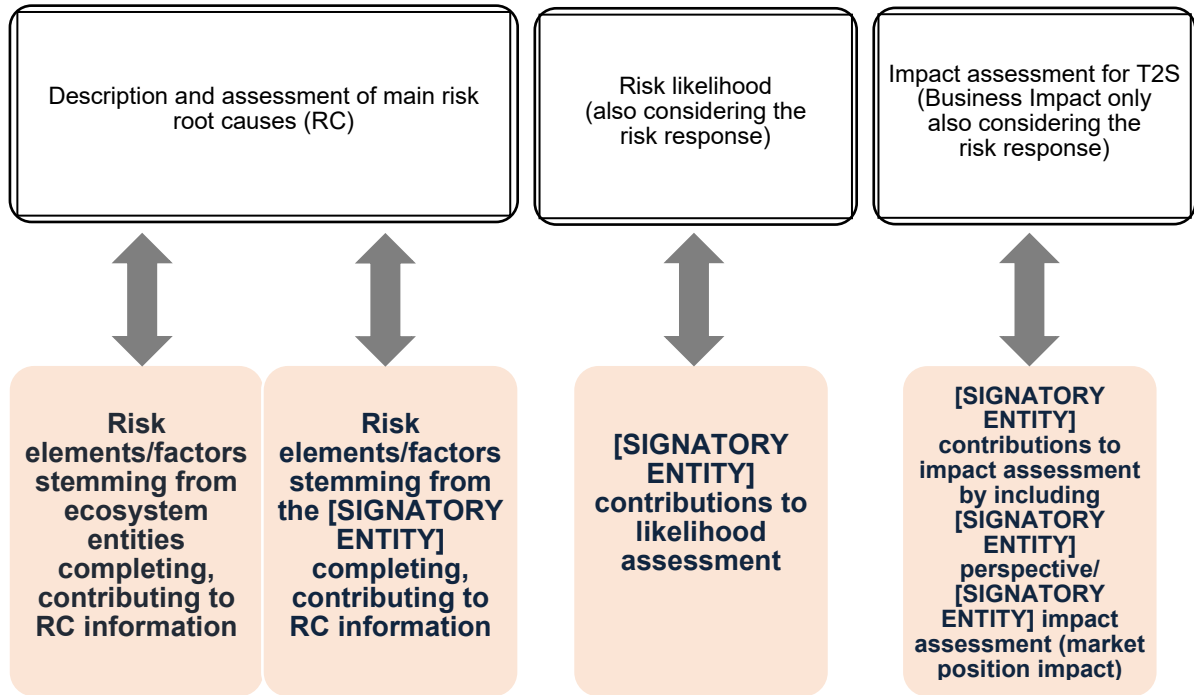

Figure 4: Inbound information



EUROPEAN CENTRAL BANK

EUROSYSTEM

T2S FRAMEWORK AGREEMENT

ANNEX 1 TO SCHEDULE 10

INTENTIONALLY LEFT BLANK



EUROPEAN CENTRAL BANK

EUROSYSTEM

T2S FRAMEWORK AGREEMENT

ANNEX 2 TO SCHEDULE 10

INTENTIONALLY LEFT BLANK



EUROPEAN CENTRAL BANK

EUROSYSTEM

T2S FRAMEWORK AGREEMENT

SCHEDULE 11 EXIT MANAGEMENT

T2S Framework Agreement

Schedule 11 – Exit Management

Table of contents

1	Introduction.....	3
2	Scope and General Approach of Exit Management	4
2.1	Scope	4
2.2	General approach of Exit Management.....	4
2.3	Relation with the non-euro area NCBs in T2S.....	4
3	Exit of the Contracting CSD.....	5
3.1	General responsibilities of the Parties	5
3.2	Responsibilities of the Contracting CSD.....	5
3.3	Responsibilities of the Eurosystem	6

T2S Framework Agreement

Schedule 11 – Exit Management

1 Introduction

This Schedule sets out the provisions related to preparing and supporting the exit of a Contracting CSD and its community from T2S, as well as the roles and responsibilities of the Parties during the exit process.

This Schedule does not cover the possible causes of termination and their consequences, nor the decision-making process, including Arbitration and escalation, which will take place in case one Party does not accept the other Party's termination of the T2S Framework Agreement for cause.

The Schedule is divided into two chapters i) scope and general approach of the Exit Management; ii) exit of a Contracting CSD to T2S addressing the responsibilities of the Parties.

T2S Framework Agreement

Schedule 11 – Exit Management

2 Scope and General Approach of Exit Management

2.1 Scope

This Schedule describes the operational and mutual support principles that will apply from the moment the Contracting CSD has formally notified the Eurosystem of its decision to exit T2S, either for convenience or for cause, or from the moment the Eurosystem has formally notified the Contracting CSD that it wishes to terminate the T2S Framework Agreement. Notifications are given by way of an official termination notice, either from the Contracting CSD to the Eurosystem, or from the Eurosystem to the Signatory CSDs.

2.2 General approach of Exit Management

Unless otherwise agreed between the Parties in writing, the exit of the Contracting CSD from T2S will consist of a full de-migration of the Contracting CSD's business on a given date (i.e. "big-bang" approach) from the T2S Platform. Such exit shall take place over a weekend, targeting to avoid sensitive weekends (e.g. end-of-month, end-of quarter).

If the Contracting CSD decides to terminate the T2S Framework Agreement for convenience, it shall maintain its internal systems sufficiently compatible with the T2S functionality and with agreed Service Levels, so as to allow T2S to provide the agreed services to other T2S Actors. This may imply that the Contracting CSD has to implement authorised changes, in particular in case of Fast-track Changes, as specified in Schedule 9 (Change and Release Management).

2.3 Relation with the non-euro area NCBs in T2S

Should a non-euro area NCB in T2S terminate the T2S Currency Participation Agreement at least six months before their planned Migration Date, which means that such non-euro area NCB in T2S will not migrate to T2S, the Eurosystem shall review the User Testing and Migration plans in accordance with the provisions laid down in Schedules 3 (User Testing) and 4 (Migration).

T2S Framework Agreement

Schedule 11 – Exit Management

3 Exit of the Contracting CSD

3.1 General responsibilities of the Parties

- a) It is the responsibility of the Eurosystem to co-ordinate, steer and monitor the exit process. In agreement with the Contracting CSD, it supports the establishment of the exit plan, the tasks and the milestones for the exit process and monitors compliance with the agreed procedures, tasks, and milestones.
- b) To the extent possible, the Parties shall use all reasonable endeavour to minimize the effects of the exit on T2S and other T2S Actors.
- c) It is the responsibility of the Contracting CSD to co-ordinate all exit activities with its T2S Users. Both Parties shall appoint an “Exit Manager”, whose main responsibility consists in co-ordinating the exit activities and acting as liaison for the other Signatory CSDs.
- d) The exit process ends when the adaptations are completed so that there are no more securities on the Securities Accounts managed by the Contracting CSD on the T2S Platform. Unless otherwise agreed between the Parties, the exit of the Contracting CSD from T2S will take the form of a simultaneous inactivation of all Securities Accounts operated by the Contracting CSD on the T2S Platform, so as to prevent any further securities settlement on those accounts. These activities will take place during a weekend agreed upon by both Parties and called the exit weekend.

After the completion of the exit process, and until the end of the legal archiving period, the Eurosystem shall continue to provide information – including but not limited to Transactional Data – to the Contracting CSD, upon the latter’s request, with respect to the services provided by the Eurosystem to the Contracting CSD in the context of the T2S Framework Agreement.

3.2 Responsibilities of the Contracting CSD

In view of ensuring a successful exit from T2S, the Contracting CSD shall:

- a) deliver to the Eurosystem, at the latest one month after the official termination notice, a high-level exit plan clearly defining all activities that – within the following conditions – the CSD itself, its DCP, the Eurosystem and, where relevant, any non-euro area NCB are to perform;
- b) ensure that all its DCPs will have stopped their direct connection to T2S at least one month before the exit weekend;
- c) agree with its Investor and Issuer CSD(s) how to re-arrange their inter-CSD links;

T2S Framework Agreement

Schedule 11 – Exit Management

- d) specify its plan to conduct tests with its Investor and Issuer CSD(s), as far as the latter remain in T2S;
- e) agree with the Central Banks whose currency it needs for DvP settlement, how the usage of cash accounts will change as a result of the exit;
- f) deliver to the Eurosystem, at the latest two months after the delivery of the high-level exit plan, the detailed support request for the execution of all exit activities, which the CSD expects from the Eurosystem;
- g) monitor and take all necessary measures to facilitate the readiness of its community for the exit from T2S;
- h) co-operate with the Eurosystem in preparation of the exit plan and the detailed exit weekend script;
- i) coordinate all exit activities with its community, including with other CSDs acting as Investor CSDs, and confirm the successful completion of the activities to the Eurosystem;
- j) inform the Eurosystem of any unexpected event or delay of a planned activity, which may affect the execution of the Eurosystem's support activities or the exit plan.

3.3 Responsibilities of the Eurosystem

In view of ensuring a successful exit from T2S, the Eurosystem shall:

- a) continue to provide all services and support as specified in the T2S Framework Agreement, until the exit weekend;
- b) provide reasonable support to the Contracting CSD in preparing its high-level exit plan;
- c) indicate to the Contracting CSD within one month after the receipt of the high-level exit plan, any constraints and conditions applicable to the support it can provide;
- d) assist the Contracting CSD in preparing its detailed support request to the Eurosystem, in particular by indicating specific areas where the Eurosystem can offer such support;
- e) agree with the Contracting CSD within one month after the receipt of the detailed support request on the precise activities that the Eurosystem will conduct, and their timing;
- f) support the Contracting CSD in establishing the exit plan, including aspects related to its Securities Accounts, accounts structures, Dedicated Cash Accounts, major project milestones, as well as checkpoints to be met before the start of the exit weekend;

T2S Framework Agreement

Schedule 11 – Exit Management

- g) inform the Contracting CSD within one month after reaching an agreement on the exit plan of the amount of any costs for planning, co-ordination and execution of exit activities – beyond the normal operational support – which it expects the CSD to reimburse, unless the Contracting CSD has terminated the T2S Framework Agreement for cause, in which case the Eurosystem will provide such support free of charge;
- h) make all reasonable efforts to conduct the agreed activities, including communication and coordination with other T2S Actors, and where relevant confirm their successful completion to the Contracting CSD;
- i) establish the detailed exit weekend script which provides the Contracting CSD with the required information to execute the tasks and/or to carry out the actions required during the exit weekend;
- j) provide all reasonable support to the Contracting CSD to address any unexpected events during the exit process;
- k) establish the fall-back arrangements and roll-back procedures specific for the exit, in order to manage the necessary processes if the exit needs to be deferred to a later stage due to predictable or unforeseen circumstances, and/or if the activities already performed during the exit weekend need to be unwound if the exit has to be stopped.



EUROPEAN CENTRAL BANK

EUROSYSTEM

T2S FRAMEWORK AGREEMENT

SCHEDULE 12

INTENTIONALLY LEFT BLANK



EUROPEAN CENTRAL BANK

EUROSYSTEM

T2S FRAMEWORK AGREEMENT

SCHEDULE 13 PROCEDURE FOR PAYMENT OF CLAIMS

T2S Framework Agreement

Schedule 13 – Procedure for payment of claims

Table of contents

1	PROCEDURE IN RESPECT OF CLAIMS PURSUANT TO ARTICLES 32 AND 33(1)(B)....	3
2	PROCEDURE IN RESPECT OF CLAIMS PURSUANT TO ARTICLE 40	5
3	PROCEDURE IN RESPECT OF CLAIMS PURSUANT TO ARTICLES 21(7) AND 33(1)(A)7	7
4	PROCEDURE IN RESPECT OF CLAIMS PURSUANT TO ARTICLE 28(4)	9

T2S Framework Agreement

Schedule 13 – Procedure for payment of claims

For the purposes of this Schedule, either Party asserting a claim against the other Party is referred to as “Claimant”, while the other Party is referred to as “Respondent”.

1 Procedure in respect of claims pursuant to Articles 32 and 33(1)(b)

The following procedure applies to the handling of any claim pursuant to Articles 32 or 33(1)(b):

- (a) The Claimant shall notify the Respondent of the occurrence of any event which the Claimant reasonably believes may give rise to a claim for liability or indemnification. This notification shall be made no later than within 30 calendar days from the occurrence of such an event or, if the Claimant did not know that an event would give rise to a claim, as from the moment it has the relevant knowledge.
- (b) The Claimant shall submit its claim against the Respondent without undue delay, and in any case no later than within 12 months from the occurrence of the event which gave rise to the claim or, if the Claimant did not know that an event gave rise to a claim for liability or indemnification, within 12 months from the moment it knew or should reasonably have known of such a claim. After the expiry of this period, the Respondent shall be entitled to reject the claim.
- (c) The Claimant shall submit its claim to the Respondent in writing, hereby specifying the amount and the justification of the claim, as well as all the information necessary to allow the Respondent to assess the merits of the submitted claim.
- (d) The Respondent may request any additional information from the Claimant as may be reasonably required for assessing the merits of the claim. The Claimant shall cooperate in good faith and in a timely manner with the Respondent.
- (e) The Respondent shall, without undue delay, notify the Claimant in writing if it accepts the claim or rejects it in whole or in part, in the latter case giving reasons for the rejection.
- (f) In case of a dispute as to the merits of the claim, the Parties shall undertake best efforts to find an amicable arrangement. As the case may be, the Parties shall take recourse to Article 43 (Arbitration).
- (g) If the Respondent has accepted the claim as merited, in whole or in part, or if it was settled either by an amicable arrangement between the Parties or through an Arbitration pursuant to Article 43, the Respondent shall, subject to paragraphs (b), (h) and (i), pay out the claim as soon as reasonably practicable and at the latest

T2S Framework Agreement

Schedule 13 – Procedure for payment of claims

within 90 calendar days after the end of the calendar year in which the event that caused the claim occurred. Any payment pursuant to Article 32 is subject to the limitations of Article 32(5)(a) and Article 32(6). Payments by the Eurosystem subject to the limitations in Article 32(5)(a) shall be made on a provisional basis subject to the reservations of paragraphs (h) and (i). The Claimant shall not be entitled to claim interest or damages for late payment in relation to the time elapsed prior to the expiry of the period of 90 calendar days.

- (h) If the liability of the Eurosystem vis-à-vis the Contracting CSD is limited in accordance with Article 32(5)(a) and the amounts payable to the Contracting CSD and, as the case may be, to other Participating CSDs are reduced accordingly, the Eurosystem shall notify all Claimants as soon as practicably possible after the end of the calendar year referred to in paragraph (g); the notification shall give sufficient evidence of the reasons for, and the calculation of, the reduced amounts paid in relation to the amounts that had been claimed.
- (i) If a claim is accepted as merited by the Eurosystem after the end of the calendar year in which the event that caused the claim occurred, or if a claim is settled either by an amicable arrangement between the Parties or through an Arbitration pursuant to Article 43 after the end of this calendar year, the Eurosystem shall pay such a claim as soon as reasonably practicable. If such a claim should be subject to a reduction pursuant to Article 32(5)(a), the Claimant shall be notified in accordance with paragraph (h) prior to the payment. To the extent that a claim paid after the end of the calendar year referred to in paragraph (g) is subject to a reduction pursuant to Article 32(5)(a), all payments previously made to the Contracting CSD or Participating CSDs with regard to this calendar year shall be recalculated in accordance with Article 32(5)(a) and the paid amounts shall be adjusted. With regard to this adjustment, the Eurosystem is entitled to claim back any payment made in excess of the adjusted pro rata entitlement according to Article 32(5)(a).

T2S Framework Agreement

Schedule 13 – Procedure for payment of claims

2 Procedure in respect of claims pursuant to Article 40

The following procedure applies to the handling of claims pursuant to Article 40:

- (a) The Claimant shall without undue delay, and in any case within a maximum period of 12 months after the date at which the termination of the Agreement became effective, submit the claim to the Respondent in writing, hereby specifying the amount and the justification of the claim, to allow the Respondent to assess the merits of the claim. After the expiry of this maximum period, the Respondent shall be entitled to reject the claim.
- (b) The Respondent may request any additional information from the Claimant as may be reasonably required for assessing the merits of the submitted claim. The Claimant shall cooperate in good faith and in a timely manner with any such requests by the Respondent.
- (c) The Respondent shall, without undue delay, notify the Claimant in writing if it accepts the claim or rejects it in whole or in part, in the latter case giving reasons for the rejection.
- (d) In case of dispute as to the merits of the claim, the Parties shall take recourse to Article 42 and, as the case may be, Article 43.
- (e) The Respondent, shall compensate any claim that it has accepted as merited, in whole or in part, or that was settled in accordance with Articles 42 or 43, as soon as reasonably practicable and at the latest within 90 calendar days after the end of the calendar year in which the claim was accepted or settled. The Claimant shall not be entitled to claim interest or damages for late payment in relation to the time elapsed prior to the expiry of the period of 90 calendar days.
- (f) The following shall apply in respect of the calculation of the loss payable by the Contracting CSD to the Eurosystem, in accordance with Article 40(1):
 - The loss shall be calculated as from the date when the termination of the Agreement became effective.
 - It shall be calculated as follows: “daily average number of securities instructions that the Contracting CSD settled, as the case may be, either in T2S or in its legacy settlement infrastructure during the 12 month preceding the date of notification of termination multiplied by the relevant T2S prices indicated in the T2S Price List multiplied by the number of days from the date when the termination became effective until the end of the Cost Recovery Period”.

T2S Framework Agreement

Schedule 13 – Procedure for payment of claims

(g) The following shall apply in respect of the calculation of any Direct Loss payable by the Eurosystem to the Contracting CSD, in accordance with Article 40(2) of this Agreement:

- The Contracting CSD shall be entitled to claim compensation for the Direct Loss it suffered as a result of its termination.
- Such Direct Loss shall be calculated as from the date when the termination of the Agreement became effective and shall cover (1) a maximum period of 24 months, or, (2) the time until the end of the T2S Cost Recovery Period, whichever of (1) or (2) is the shorter period.
- To the extent the Contracting CSD's Direct Loss relates to interest on its T2S related investments made, the amount of such interest shall be determined as follows: "amount of T2S related investment multiplied by the number of days multiplied by the ECB Main Refinancing Rate (as applicable during the period for which the Eurosystem has to pay compensation)".
- The Direct Loss that the Eurosystem has to pay shall be limited to the equivalent of the T2S fees that the Contracting CSD could be reasonably expected to pay during the period of 24 months after the date when the termination of the Agreement became effective. The Contracting CSD's expected T2S fees shall be determined as follows: "daily average number of securities instructions that the Contracting CSD settled, as the case may be, either in T2S or in its legacy settlement infrastructure during the 12 month preceding the date of notification of termination multiplied by the relevant T2S prices indicated in the T2S Price List multiplied by the number of days the Eurosystem has to pay compensation (max. 24 months from the date when the termination became effective, but no longer than until the end of the Cost Recovery Period)".

T2S Framework Agreement

Schedule 13 – Procedure for payment of claims

3 Procedure in respect of claims pursuant to Articles 21(7) and 33(1)(a)

The following procedure applies in addition to Articles 21(7) and 33(1)(a) if legal action is commenced or threatened against the Eurosystem:

- (a) If the Eurosystem allows the Contracting CSD to control the defense against the Third Party claimant, the Contracting CSD shall keep the Eurosystem informed of all material matters at all times. Notwithstanding such agreement regarding the control over the defense, the Eurosystem, being the formal party to the legal proceedings, and the Contracting CSD shall agree on the way in which the proceedings are conducted. For this purpose, and in due consideration of the agreement to give the Contracting CSD control over the defense, the Eurosystem shall be entitled to object to legal submissions proposed by the Contracting CSD that it considers harmful to the outcome of such proceedings and to make its own counter proposals towards the Contracting CSD. Expenses of the Eurosystem in the context of such involvement shall be borne by the Eurosystem.
- (b) At the request of the Contracting CSD the Eurosystem shall give all reasonable assistance and provide all relevant documents and data which are under its control, to the extent permissible under the applicable statutory and contractual law. The Contracting CSD shall indemnify the Eurosystem for all reasonable cost the latter incurred in that context.

The following procedure applies in addition to Articles 21(7) and 33(1)(a) if the Eurosystem is held legally liable to the Third Party:

- (c) The Eurosystem shall notify the Contracting CSD of the fact that it is held liable to the Third Party pursuant to an Enforceable Judgment. The notification shall be sent as soon as reasonably practicable but in no case later than 30 days after the full text of the Enforceable Judgment was available to the Eurosystem.
- (d) The notification shall contain a statement to the effect that the Eurosystem intends to claim reimbursement from the Contracting CSD, the text of the Enforceable Judgment (to the extent available) and a preliminary indication of the amount and composition of the claim.
- (e) The Eurosystem shall submit its claim to the Contracting CSD in writing and without undue delay and in any case no later than 90 calendar days after the full text of the Enforceable Judgment was made available to the Eurosystem. A delay shall not

T2S Framework Agreement

Schedule 13 – Procedure for payment of claims

relieve the Contracting CSD of its obligation to reimburse the Eurosystem, except to the extent that the Contracting CSD can demonstrate that the delay caused damages.

- (f) The Eurosystem shall precisely set out the amount and the various components of the payment it owes to the Third Party and for which it claims reimbursement from the Contracting CSD. The Contracting CSD may request any additional information from the Eurosystem as may be reasonably required for assessing the merits of the submitted claim. The Eurosystem shall cooperate in good faith with any such request by the Contracting CSD.
- (g) The Contracting CSD shall notify the Eurosystem in writing within 90 calendar days from the day of the receipt of the claim if it accepts the claim or rejects it in whole or in part, in the latter case giving reasons for the rejection.
- (h) In case of dispute as to the merits of the claim, the Parties shall take recourse to Article 43 (Arbitration).
- (i) The Eurosystem shall subrogate the Contracting CSD to any rights it may have against Third Parties in relation to the reimbursed claim.

T2S Framework Agreement

Schedule 13 – Procedure for payment of claims

4 Procedure in respect of claims pursuant to Article 28(4)

The following procedure applies in addition to Article 28(4) if legal action is commenced or threatened against the Contracting CSD:

- (a) If the Contracting CSD allows the Eurosystem to control the defense against the Third Party claimant, the Eurosystem shall keep the Contracting CSD informed in all material matters at all times. Notwithstanding such agreement regarding the control over the defense, the Contracting CSD, being the formal party to the legal proceedings, and the Eurosystem shall agree on the way in which the proceedings are conducted. For this purpose, and in due consideration of the agreement to give the Eurosystem control over the defense, the Contracting CSD shall be entitled to object to legal submissions proposed by the Eurosystem that it considers harmful to the outcome of such proceedings and to make its own counter proposals towards the Eurosystem. Expenses of the Contracting CSD in the context of such involvement shall be borne by the Contracting CSD.
- (b) At the request of the Eurosystem the Contracting CSD shall give all reasonable assistance and provide all relevant documents and data which are under its control, to the extent permissible under the applicable statutory and contractual law. The Eurosystem shall indemnify the Contracting CSD for all reasonable cost the latter incurred in that context.

The following procedure applies in addition to Article 28.4(b) if the Contracting CSD is held legally liable to the Third Party:

- (c) The Contracting CSD shall notify the Eurosystem of the fact that it is held liable to the Third Party pursuant to an Enforceable Judgment. The notification shall be sent as soon as reasonably practicable but in no case later than 30 days after the full text of the Enforceable Judgment was available to the Contracting CSD.
- (d) The notification shall contain a statement to the effect that the Contracting CSD intends to claim reimbursement from the Eurosystem, the text of the Enforceable Judgment (to the extent available) and a preliminary indication of the amount and composition of the claim.
- (e) The Contracting CSD shall submit its claim to the Eurosystem in writing and without undue delay and in any case no later than 90 calendar days after the full text of the Enforceable Judgment was made available to the Contracting CSD. A delay shall not relieve the Eurosystem of its obligation to reimburse the Contracting CSD,

T2S Framework Agreement

Schedule 13 – Procedure for payment of claims

except to the extent that the Eurosystem can demonstrate that the delay caused damages.

- (f) The Contracting CSD shall precisely set out the amount and the various components of the payment it owes to the Third Party and for which it claims reimbursement from the Eurosystem. The Eurosystem may request any additional information from the Contracting CSD as may be reasonably required for assessing the merits of the submitted claim. The Contracting CSD shall cooperate in good faith with any such request by the Eurosystem.
- (g) The Eurosystem shall notify the Contracting CSD in writing within 90 calendar days from the day of the receipt of the claim if it accepts the claim or rejects it in whole or in part, in the latter case giving reasons for the rejection.
- (h) In case of dispute as to the merits of the claim, the Parties shall take recourse to Article 43 (Arbitration).
- (i) The Contracting CSD shall subrogate the Eurosystem to any rights it may have against Third Parties in relation to the reimbursed claim.