



EUROPEAN CENTRAL BANK

EUROSYSTEM

**ECB**  
DG-MIP  
T2/T2S Consolidation Project Team

# T2/T2S Consolidation

## URD Methodology

Task Force on Future RTGS Services

1<sup>st</sup> meeting on 07 December 2016

## URD - Approach

### Today's targets:

### How to get there:

---

1. Agree on the methodology how to compile the URD



➤ Definition of the main steps and responsibilities in the URD development process

---

2. Reach a common understanding on the URD template



➤ Presentation of the template

---

3. Discuss/agree on the general URD structure in terms of content



➤ Discuss and agree on the logical components of the future RTGS services

## URD - Process

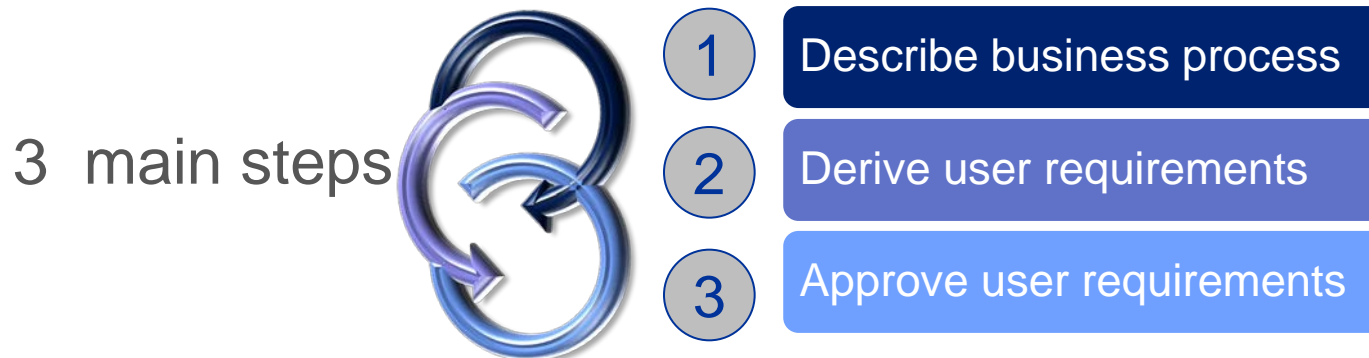

- Responsibilities:
  - The T2/T2S Consolidation project team will draft the business processes and related user requirements
  - The Task Force on Future RTGS services will review and validate the URD consisting of business processes and user requirements
- Work will be performed in parallel to achieve tight timelines. This requires intense and clear communication with a flexible mix of physical meetings, teleconferences and written procedures
- Resulting from this process, just one document will be produced

## URD - Template: Structure and Elements (I/II)

- The overview of RTGS Business domains and their logical arrangement/interaction within the Business processes determines the structure of the URD; i.e. each Business domain should be reflected by a single chapter

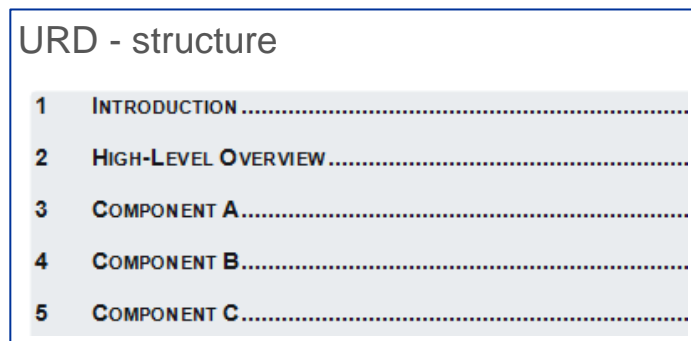
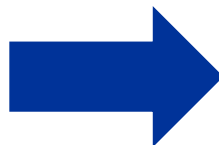
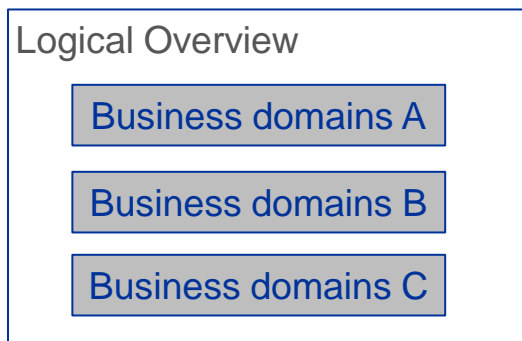

- Each business processes makes use of various Business domains and therefore consist of several Business domain related sub-processes. The corresponding user requirement will be derived from the sub-processes

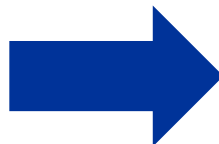
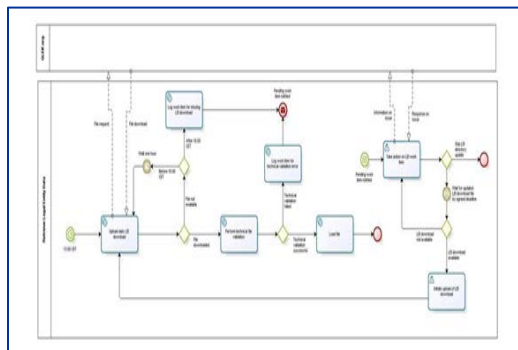

<b>ID</b>	RTGS.01.123
<b>Name</b>	This is a placeholder for the name of the req
<b>Requirement</b>	Lorem ipsum dolor sit amet, consectetur at incididunt ut labore et dolore magna aliqua. U exercitation ullamco laboris nisi ut aliquip ex e dolor in reprehenderit in voluptate velit esse Excepteur sint occaecat cupidatat non proci mollit anim id est laborum.

## URD - Template: Structure and Elements (II/II)

- The URD is a document consisting of Business domain related sub-processes and corresponding user requirements:

**3 COMPONENT A**

**3.1 SUB-PROCESS 1**

Lorem ipsum dolor sit amet, consectetur adipiscing elit, sed do eiusmod tempor incididunt ut labore et dolore magna aliqua. Ut enim ad minim veniam, quis nostrud exercitation ullamco laboris nisi ut aliquip ex ea commodo consequat. Duis aute irure dolor in reprehenderit in voluptate velit esse cillum dolore eu fugiat nulla pariatur. Excepteur sint occaecat cupidatat non proident, sunt in culpa qui officia deserunt mollit anim id est laborum.

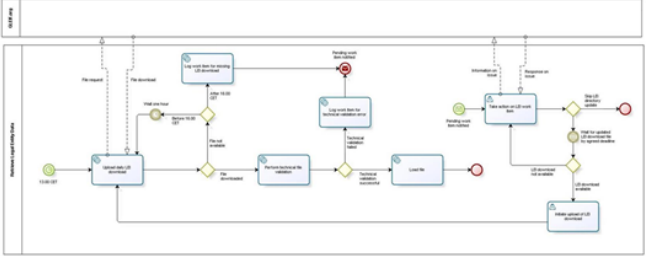

Lorem ipsum dolor sit amet, consectetur adipiscing elit, sed do eiusmod tempor incididunt ut labore et dolore magna aliqua. Ut enim ad minim veniam, quis nostrud exercitation ullamco laboris nisi ut aliquip ex ea commodo consequat. Duis aute irure dolor in reprehenderit in voluptate velit esse cillum dolore eu fugiat nulla pariatur. Excepteur sint occaecat cupidatat non proident, sunt in culpa qui officia deserunt mollit anim id est laborum.

<b>ID</b>	<b>RTGS.01.123</b>
<b>Name</b>	This is a placeholder for the name of the requirement.
<b>Requirement</b>	Lorem ipsum dolor sit amet, consectetur adipiscing elit, sed do eiusmod tempor incididunt ut labore et dolore magna aliqua. Ut enim ad minim veniam, quis nostrud exercitation ullamco laboris nisi ut aliquip ex ea commodo consequat. Duis aute irure dolor in reprehenderit in voluptate velit esse cillum dolore eu fugiat nulla pariatur. Excepteur sint occaecat cupidatat non proident, sunt in culpa qui officia deserunt mollit anim id est laborum.

← Space for supporting information

← Business process chart (BPMN) - extract

← Business sub-process description

← Unique ID

← Unique title/name

← Precise description

} Business sub-process

} User Requirement(s)

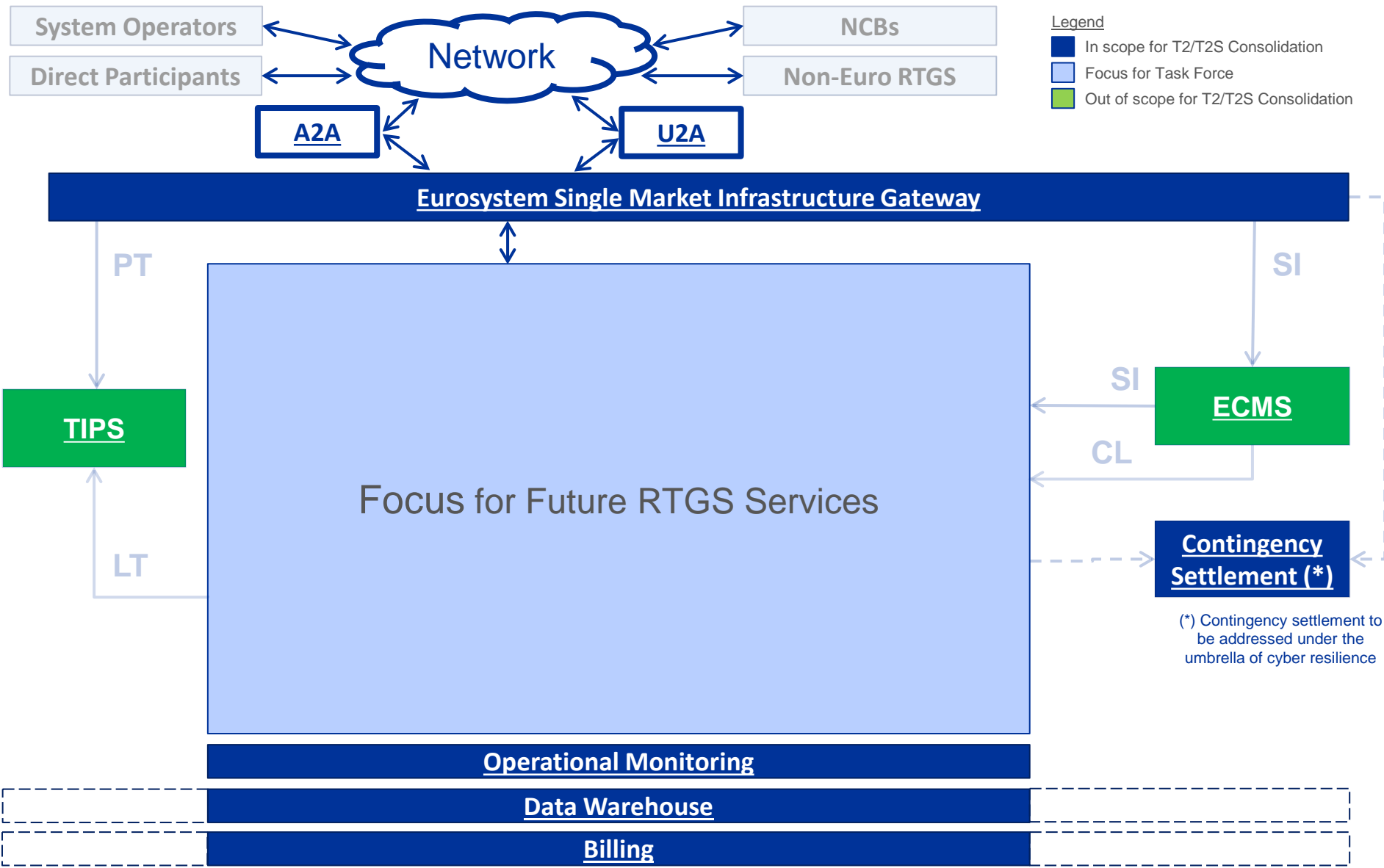

**Legend**

- In scope for T2/T2S Consolidation
- Focus for Task Force
- Out of scope for T2/T2S Consolidation

(\*) Contingency settlement to be addressed under the umbrella of cyber resilience

PT – Payment Transaction; LT – Liquidity Transfer; SI – Settlement Instruction; CL – Credit Lines

- Logical overview of a future RTGS service determines the structure of the URD
- The structural outline of the URD will be drafted based on the Business Domains

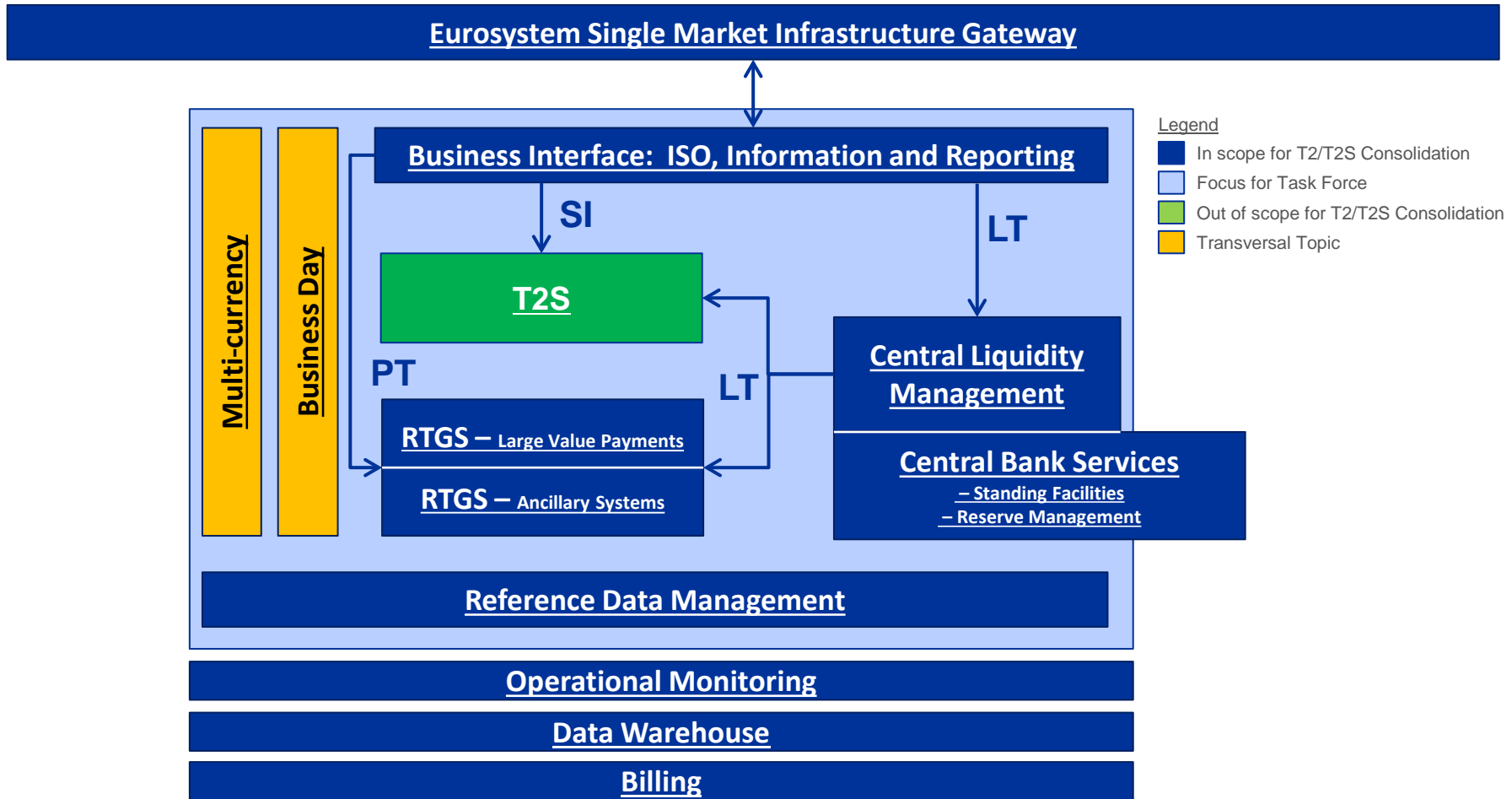

PT – Payment Transaction; LT – Liquidity Transfer; SI – Settlement Instruction; CL – Credit Lines

